







As you read this manual, you will find Information that is preceded by a symbol **NOTICE**. This information is intended to help you avoid damage to your vehicle, other property, or the environment.

Symbols   or   on labels attached to your vehicle are to remind you to read this owner's manual for proper and safe operation of your vehicle.

 or   is colour-coded to indicate "danger" (red), "warning" (orange), or "caution" (amber).

 **Safety Labels** P. 103

A Few Words About Safety

Your safety, and the safety of others, is very important. And operating this vehicle safely is an important responsibility.

To help you make informed decisions about safety, we have provided operating procedures and other information on labels and in this manual. This information alerts you to potential hazards that could hurt you or others.

Of course, it is not practical or possible to warn you about all the hazards associated with operating or maintaining your vehicle. You must use your own good judgement.

You will find this important safety information in a variety of forms, including:

- **Safety Labels** - on the vehicle.
- **Safety Messages** - preceded by a safety alert symbol  and one of three signal words: **DANGER**, **WARNING**, or **CAUTION**. These signal words mean:

 **DANGER**

You WILL be KILLED or SERIOUSLY HURT if you don't follow instructions.

 **WARNING**

You CAN be KILLED or SERIOUSLY HURT if you don't follow instructions.

  **WARNING**

You CAN be KILLED or SERIOUSLY HURT if you don't follow instructions.

 **CAUTION**

You CAN be HURT if you don't follow instructions.

- **Safety Headings** - such as Important Safety Precautions.
- **Safety Section** - such as Safe Driving.
- **Instructions** - how to use this vehicle correctly and safely.

This entire book is filled with important safety information - please read it carefully.

Event Data Recorders

Your vehicle is equipped with several devices commonly referred to as Event Data Recorders. They record various types of real time vehicle data such as SRS airbag deployment and SRS system components failure.

This data belongs to the vehicle owner and may not be accessed by anyone else except as legally required or with the permission of the vehicle owner.

However this data may be accessed by Honda, its authorised dealers and authorised repairers, employees, representatives and contractors only for the purpose of the technical diagnosis, research and development of the vehicle.

Service Diagnostic Recorders

Your vehicle is equipped with service-related devices that record information about powertrain performance and driving conditions. The data can be used to help technicians diagnose, repair and maintain the vehicle. This data may not be accessed by anyone else except as legally required or with the permission of the vehicle owner.

However this data may be accessed by Honda, its authorised dealers and authorised repairers, employees, representatives and contractors only for the purpose of the technical diagnosis, research and development of the vehicle.

Owner's Manual Application Terms and Conditions

General

This application allows your Display Audio to automatically search for owner's manual updates that are specific to your vehicle and Display Audio every time the power mode of the vehicle is set to ON. This application periodically transmits a limited amount of vehicle and device information to our servers: Vehicle Identification Number (VIN), Display Audio hardware serial number, preferred language, Internet Protocol (IP) address, transaction log (alerts for or views of updates, update downloads and installation, usage of the owner's manual application), etc. When the application finds an update from the server, it prompts you to download and install.

When your Display Audio searches our servers for updates, we will automatically provide you with the opportunity to update the owner's manual. We will also maintain a log of the updates that are installed on our servers.

Your Personal Data

Should the aforementioned information transmitted to Honda constitute personal information in your region, please note that this information will be treated in strict accordance with the rules and regulations outlined in this notice as well as applicable data protection law.

The terms of our privacy policy are incorporated into these terms by reference and your use of system updates will be subject to the privacy policy. Our privacy policy sets out information about how we and any named third parties will process any personal data we collect from you or that you provide to us, via the utility. (See the Honda website (<https://www.privacynotice.honda.eu>) for further details.)

Honda collects, uses, and stores your personal data for the reasons set out below:

Where necessary for Honda's legitimate interests, as listed below, and where our interests are not overridden by your data protection rights.

- to deliver owner's manual updates to you;
- to allow us to improve and optimize the owner's manual application and services;
- to respond to user questions and complaints; and for internal record keeping.

Protecting our legitimate business interests and legal rights. This includes, but is not limited to, use in connection with compliance, regulatory, auditing, legal claims (including disclosure of such information in connection with legal process or litigation) and other ethics and compliance reporting requirements

Honda will also convert personal data into anonymous data and use it (normally on an aggregated statistical basis) for uses such as market research and analysis, to improve the owner's manual, to analyze trends, and to assess the success of software update releases. Aggregated personal information does not personally identify you or any other use of the owner's manual.

Honda may share this data with Honda's world wide support organization or affiliated Honda companies or other third parties engaged by Honda for the purposes of rendering support services in connection with system support.

System Updates Terms and Conditions

General

Your vehicle has an application that allows your Display Audio to automatically search for Honda software updates that are specific to your Display Audio and its connected devices (initially every one (1) week via Wi-Fi or every four (4) weeks via Telematics Control Unit (TCU)*, queries may occur more or less frequently due to internet outages, retries, direct user action, WAP push from the server or a change in query policy on the Honda servers). This application periodically transmits to our servers a limited amount of vehicle and device information (Vehicle Identification Number (VIN), the Model Type (MT) Identification Number, Hardware and Software Part Number, Serial Number, Software Version, preferred language, Internet Protocol (IP) address, Transaction Log (alert or update viewing, update download and installation, software status), etc.). When the application finds an update from the server, the application initially asks permission to download and install the update. Where available, in your settings menu you may elect to automatically download and install these updates or you may elect to manually update the system.

When your Display Audio searches our servers for updates or alerts, we will automatically provide you with the opportunity to update your devices or transmit the update or alert directly to your Display Audio. We will also maintain on our servers a log of the updates or alerts that are installed.

Your Personal Data

Should the aforementioned information transmitted to Honda constitute personal information in your region, please note that this information will be treated in strict accordance with the rules and regulations outlined in this notice as well as applicable data protection law.

The terms of our privacy policy are incorporated into these terms by reference and your use of system updates will be subject to the privacy policy. Our privacy policy sets out information about how we and any named third parties will process any personal data we collect from you or that you provide to us, via the application. See the Honda website for further details.

Honda collects, uses and stores your personal data for the reasons set out below:

- to deliver the system updates and related services to you;
- to allow us to improve and optimize the system updates products and services;
- to respond to user questions and complaints; and for internal record keeping.
- where necessary for Honda's legitimate interests, as listed below, and where our interests are not overridden by your data protection rights.

Protecting our legitimate business interests and legal rights includes, but is not limited to, use in connection with compliance, regulatory, auditing, legal claims (including disclosure of such information in connection with legal process or litigation) and other ethics and compliance reporting requirements.

Honda will also convert personal data into anonymous data and use it (normally on an aggregated statistical basis) for uses such as market research and analysis, to improve the system updates, to analyze trends, and to assess the success of software update releases. Aggregated personal information does not personally identify you or any other use of the system updates.

Honda may share this data with Honda's worldwide support organization or affiliated Honda companies or other third parties engaged by Honda for the purposes of rendering support services in connection with system support.

* Not available on all models

This owner's manual should be considered a permanent part of the vehicle and should remain with the vehicle when it is sold.

This owner's manual covers all models of your vehicle. You may find descriptions of equipment and features that are not on your particular model.

Images throughout this owner's manual represent features and equipment that are available on some, but not all, models. Your particular model may not have some of these features.

The information and specifications included in this publication were in effect at the time of approval for printing. Honda Motor Co., Ltd. reserves the right, however, to discontinue or change specifications or design at any time without notice and without incurring any obligation.

Although this manual is applicable to both right-hand and left-hand drive models, the illustrations contained in this manual mainly refer to the left-hand drive models.

➤ Safe Driving P. 39

For Safe Driving P. 40 Seat Belts P. 45 Airbags P. 57

➤ Instrument Panel P. 105

Indicators P. 106 Gauges and Displays P. 154

➤ Controls P. 171

Locking and Unlocking the Doors P. 172 Tailgate P. 186
Operating the Switches Around the Steering Wheel P. 197
Interior Convenience Items P. 234 Climate Control System P. 246

➤ Features P. 253

Audio System P. 254 Display Audio P. 256
Emergency Call (eCall) P. 368

➤ Driving P. 373

Before Driving P. 374 Towing a Trailer P. 378 When Driving P. 379
Multi-View Camera P. 517 Honda Parking Pilot P. 531

➤ Maintenance P. 571

Before Performing Maintenance P. 572 Service Reminder System* P. 576
Checking and Maintaining Wiper Blades P. 598
Climate Control System Maintenance P. 616

➤ Handling the Unexpected P. 629

If a Tyre Goes Flat P. 630 Handling of the Jack P. 643
Indicator, Coming On/Blinking P. 651 Fuses P. 658 Emergency Towing P. 667
If You Cannot Open the Tailgate P. 670

➤ Information P. 671

Specifications P. 672 Identification Numbers P. 674

Contents

Pop-up Hood System P. 72	Child Safety P. 75	Safety Labels P. 103
Security System P. 188	Windows P. 194	
Adjustment of Each Type of Mirror P. 215	Seats P. 226	
Audio Error Messages P. 357	General Information on the Audio System P. 358	
Honda Sensing P. 425	Braking P. 497	Parking Your Vehicle P. 507
Charging P. 556	Energy Economy P. 570	
Maintenance Schedule* P. 581	Maintenance Under the Bonnet P. 585	Replacing Light Bulbs P. 594
Checking and Maintaining Tyres P. 603	12-Volt Battery P. 608	Remote Transmitter Care P. 614
Cleaning P. 620	Accessories and Modifications P. 626	
Power System Won't Start P. 644	If the 12-Volt Battery Is Dead P. 647	Overheating P. 650
If You Cannot Open the Charge Lid P. 668	If You Cannot Disengage the Charging Connector P. 669	
Devices that Emit Radio Waves P. 675	Declaration of Conformity Content Outline* P. 685	

Quick Reference Guide P. 6

Safe Driving P. 39

Instrument Panel P. 105

Controls P. 171

Features P. 253

Driving P. 373

Maintenance P. 571

Handling the Unexpected P. 629

Information P. 671

Index P. 687

Visual Index

Left-hand Drive Type

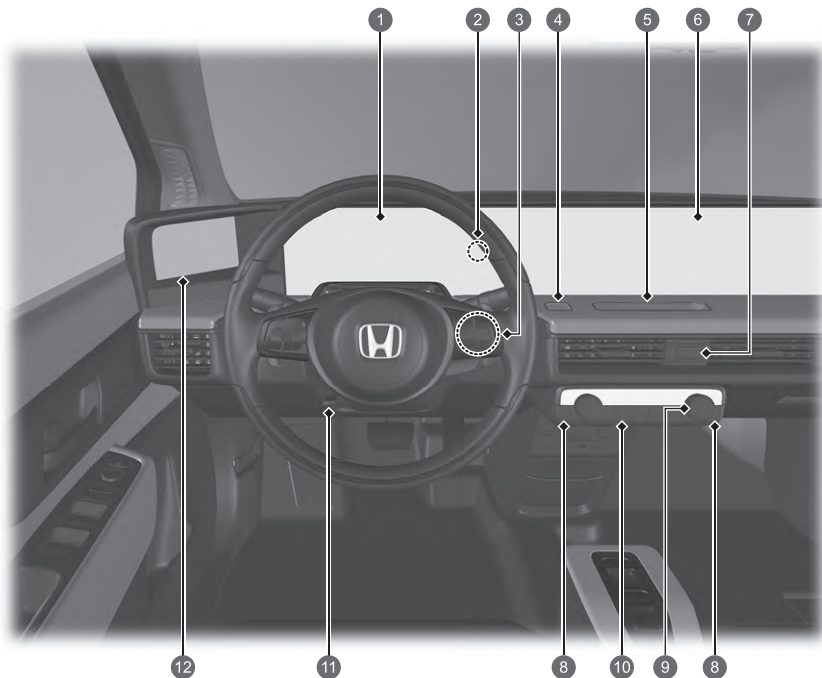

- 1 System Indicators ➔ P.106
- Gauges ➔ P.154
- Driver Information Interface ➔ P.156
- 2 Immobilizer System Indicator/Security System Alarm Indicator ➔ P.121
- 3 POWER Button ➔ P.197
- 4 Honda Parking Pilot Button ➔ P.531
- 5 Brightness Control ➔ P.257
- 6 Audio System ➔ P.254
- Navigation System
➔ See the Navigation System Manual
- 7 Hazard Warning Button
- 8 Seat Heater Buttons ➔ P.245
- 9 Climate Control System ➔ P.246
- 10 Rear Demister ➔ P.213
- 11 Steering Wheel Adjustments ➔ P.214
- 12 Side Camera Mirror System Screen ➔ P.220



- 1 System Indicators ➔ P.106
- Gauges ➔ P.154
- Driver Information Interface ➔ P.156
- 2 POWER Button ➔ P.197
- 3 Side Camera Mirror System Screen ➔ P.220
- 4 Steering Wheel Adjustments ➔ P.214
- 5 Seat Heater Buttons ➔ P.245
- 6 Rear Demister ➔ P.213
- 7 Climate Control System ➔ P.246
- 8 Hazard Warning Button
- 9 Audio System ➔ P.254
- Navigation System ➔ See the Navigation System Manual
- 10 Brightness Control ➔ P.257
- 11 Honda Parking Pilot Button ➔ P.531
- 12 Immobilizer System Indicator/Security System Alarm Indicator ➔ P.121

Visual Index

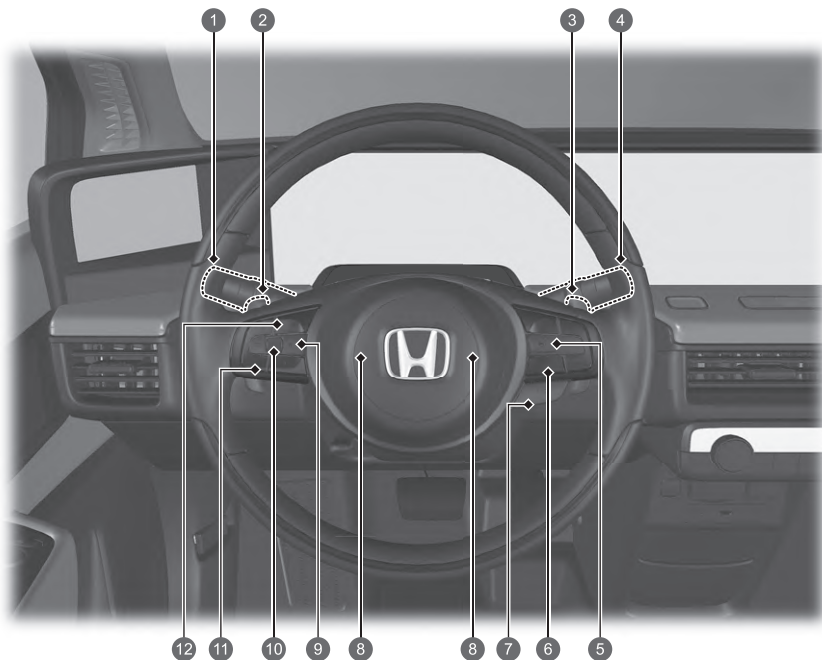

- 1 **Headlights/Turn Signals** ➔ P.201, 202
Front Fog Lights ➔ P.204
Rear Fog Lights ➔ P.204
Side Camera Mirror System Button ➔ P.223
- 2 **Paddle Selector (-)** ➔ P.393
- 3 **Paddle Selector (+)** ➔ P.393
- 4 **Wipers/Washers** ➔ P.210
CAMERA Button ➔ P.518
- 5 **Adaptive Cruise Control (ACC) with Low Speed Follow Buttons** ➔ P.445
- 6 **Lane Keeping Assist System (LKAS) Button** ➔ P.465
Interval Button ➔ P.457
- 7 **Heated Steering Wheel Button** ➔ P.244
- 8 **Horn (Press an area around )**
- 9 ** (Home) Button** ➔ P.156, 261
- 10 **Left Selector Wheel** ➔ P.156, 261
- 11 **Audio Remote Controls** ➔ P.261
- 12 **Hands-Free Telephone System Buttons** ➔ P.339
Voice Control Buttons ➔ P.264

Left-hand Drive Type

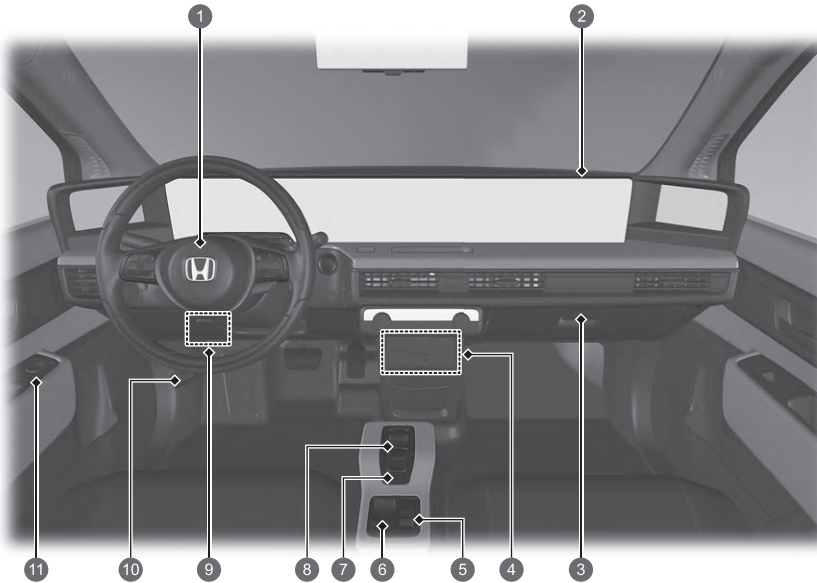

- 1 Driver's Front Airbag ➔ P. 59
- 2 Passenger's Front Airbag ➔ P. 59
- 3 Glove Box ➔ P. 237
- 4 Accessory Power Socket ➔ P. 242
AC Power Outlet* ➔ P. 243
USB Ports ➔ P. 259
HDMI™ Port ➔ P. 260
- 5 Drive Mode Switch ➔ P. 391
- 6 Electric Parking Brake Switch ➔ P. 497
Automatic Brake Hold Button ➔ P. 501
- 7 Single Pedal Control Switch ➔ P. 397
- 8 Shift Button ➔ P. 384
- 9 Interior Fuse Box ➔ P. 661
- 10 Bonnet Release Handle ➔ P. 586
- 11 Side Camera Mirror System Controls ➔ P. 221
Master Door Lock Switch ➔ P. 183
Power Window Switches ➔ P. 194

Visual Index

Right-hand Drive Type

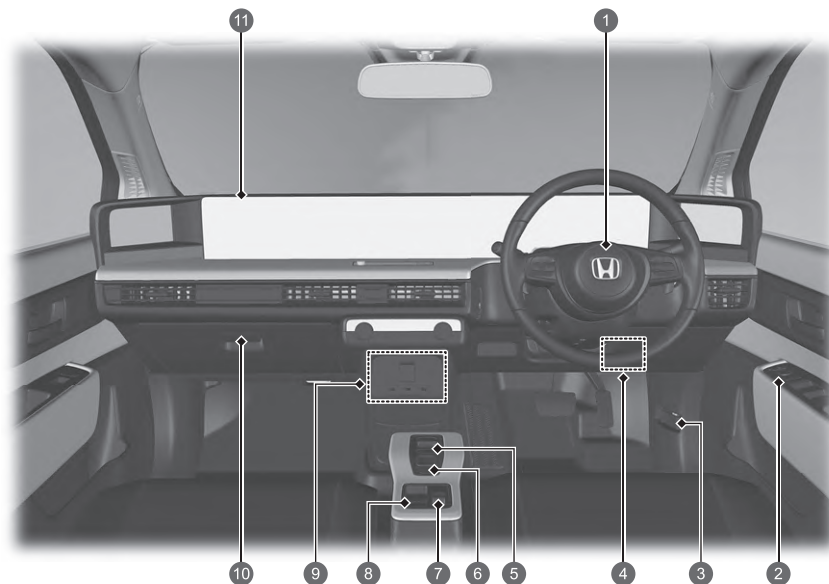

- 1 Driver's Front Airbag ➔ P. 59
- 2 Side Camera Mirror System Controls ➔ P. 221
- Master Door Lock Switch ➔ P. 183
- Power Window Switches ➔ P. 194
- 3 Bonnet Release Handle ➔ P. 586
- 4 Interior Fuse Box ➔ P. 661
- 5 Shift Button ➔ P. 384
- 6 Single Pedal Control Switch ➔ P. 397
- 7 Drive Mode Switch ➔ P. 391
- 8 Electric Parking Brake Switch ➔ P. 497
- Automatic Brake Hold Button ➔ P. 501
- 9 Accessory Power Socket ➔ P. 242
- AC Power Outlet ➔ P. 243
- USB Ports ➔ P. 259
- HDMI™ Port ➔ P. 260
- 10 Glove Box ➔ P. 237
- 11 Passenger's Front Airbag ➔ P. 59

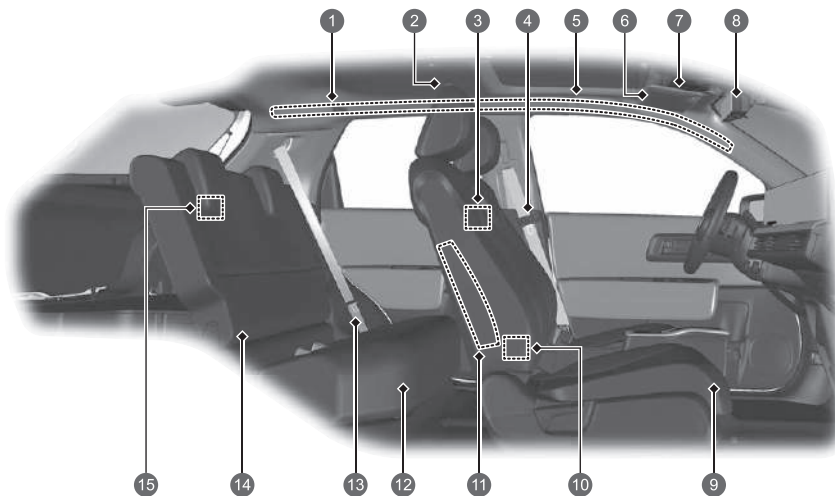

- 1 Side Curtain Airbags ➔ P. 67
- 2 Map Lights ➔ P. 235
- 3 Map Lights Switch ➔ P. 235
- 4 Seat Belts ➔ P. 45
- 5 Grab Handle
- 6 Sun Visors
Vanity Mirrors
- 7 Map Lights ➔ P. 235
Ultrasonic Sensor OFF Button* ➔ P. 191
Tilt Sensor OFF Button* ➔ P. 192
SOS Button ➔ P. 370
- 8 Centre Camera Mirror System ➔ P. 215
- 9 Front Seat ➔ P. 226
- 10 USB Ports ➔ P. 259
- 11 Side Airbags ➔ P. 65
- 12 Rear Seat ➔ P. 229
- 13 Seat Belt (Installing a Child Restraint System) ➔ P. 96
Seat Belt to Secure a Child Restraint System ➔ P. 98
- 14 Lower Anchorage Points to Secure a Child Restraint Systems ➔ P. 91
- 15 Luggage Area Light ➔ P. 236

Visual Index

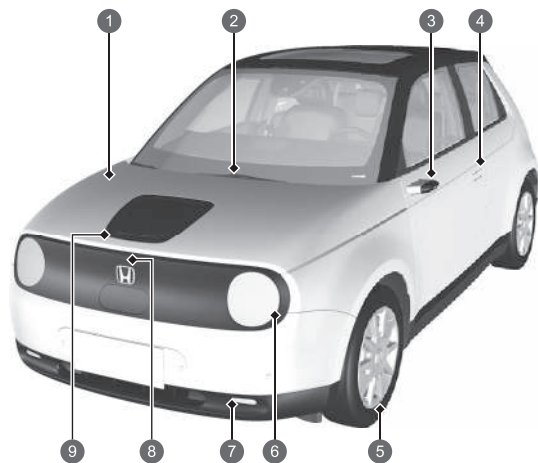

- 1 Maintenance Under the Bonnet ➔ P.585
- 2 Windscreen Wipers ➔ P.210, 598
- 3 Side Camera Mirror System ➔ P.220
Side Turn Signal Lights ➔ P.202, 594
- 4 Door Lock/Unlock Control ➔ P.175
- 5 Tyres ➔ P.603, 630
- 6 Headlights ➔ P.201, 594
Position/Daytime Running Lights ➔ P.201, 205, 594
Front Turn Signal Lights ➔ P.202, 594
- 7 Front Fog Lights ➔ P.204, 594
- 8 Lid Open Button ➔ P.560, 565
- 9 How to Charge ➔ P.560, 565

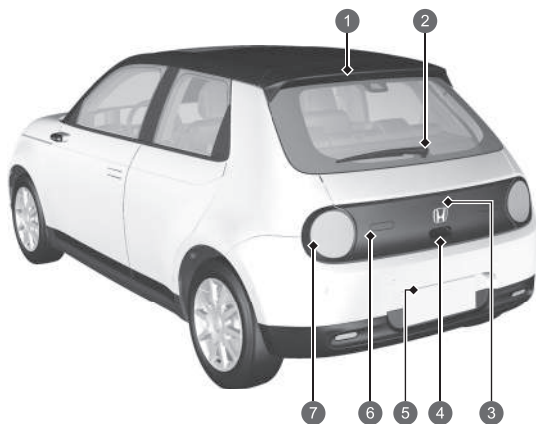

- ① High-Mount Brake Light ➔ P. 595
- ② Rear Wiper ➔ P. 212, 601
- ③ Multi-View Camera ➔ P. 517
- ④ Opening/Closing the Tailgate ➔ P. 186
Tailgate Outer Handle ➔ P. 187
- ⑤ Rear Licence Plate Lights ➔ P. 201, 595
- ⑥ Back-Up Lights ➔ P. 595
Rear Fog Light ➔ P. 204, 595
- ⑦ Taillights ➔ P. 201, 594
Brake Lights ➔ P. 594
Rear Turn Signal Lights ➔ P. 202, 594

Making Good Use of Your Honda Electric Vehicle



Charging at Home

Your Honda electric vehicle can be charged with an appropriately configured household outlet. If a timer has been set, charging automatically starts and ends.

➡ P. 556

➡ P. 563

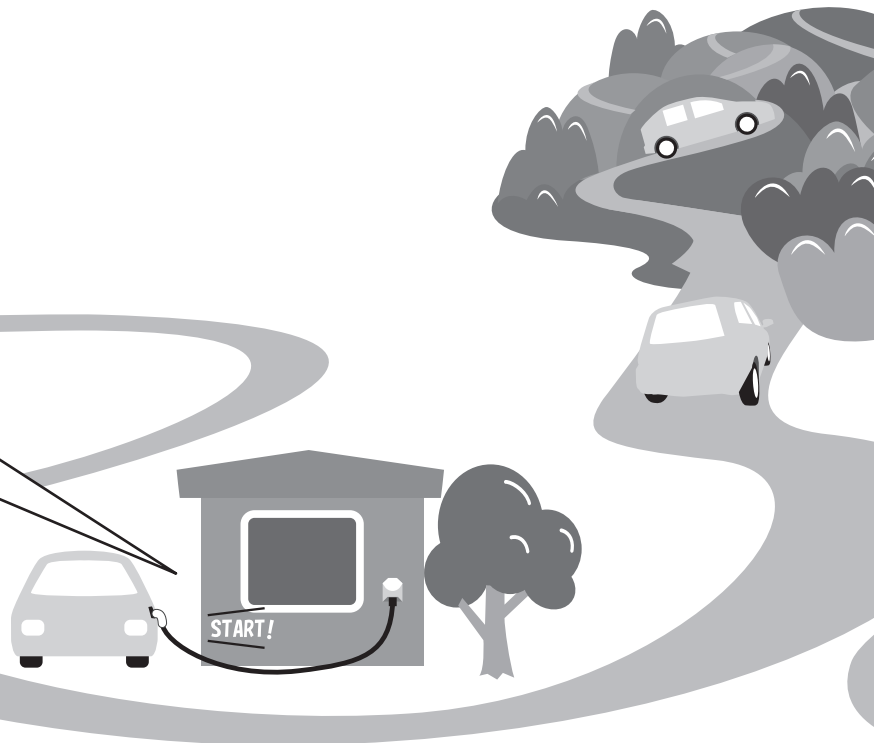

 **Parking**

There are several things you need to know when parking your Honda electric vehicle.

➔ P. 568

 **How the electric vehicle works**

An electric motor propels your Honda electric vehicle.

➔ P. 16

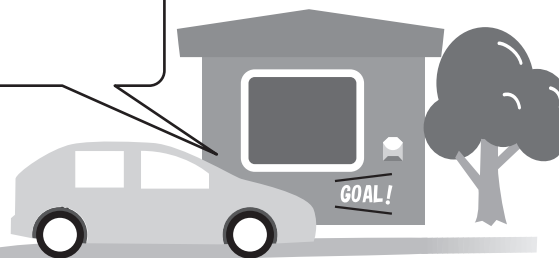

How the Electric Vehicle Works

Instead of using gasoline to power an internal combustion engine, your vehicle uses stored electricity to power an electric propulsion motor. As with a gasoline powered vehicle, the efficiency of an electric vehicle (and the vehicle's range) is most impacted by the driver's driving style. Climate control system usage also has a strong impact with heavy usage negatively affecting the vehicle's range.

There are two types of batteries used in this vehicle, a standard 12-volt battery that powers the airbags, the interior and exterior lights, and other standard 12-volt systems, and a high voltage lithium ion battery that is used to power the propulsion motor and recharge the 12-volt battery.

When the power mode is set to VEHICLE OFF, recharging will be suspended for about three days if the power mode remains on VEHICLE OFF.

Charging the High Voltage Battery

You can recharge the High Voltage battery using a standard household outlet or at a public charging station.

➔ P. 556

Electric Vehicle Precautions

High Voltage Components, High Voltage Cables and High Temperature Components

Electric vehicles have high voltage components (about 650 V maximum) such as the power control unit, High Voltage battery, high voltage cables (identified by their orange covers), electric motor, and high temperature parts such as the radiator. Labels with handling warnings are attached to these components.

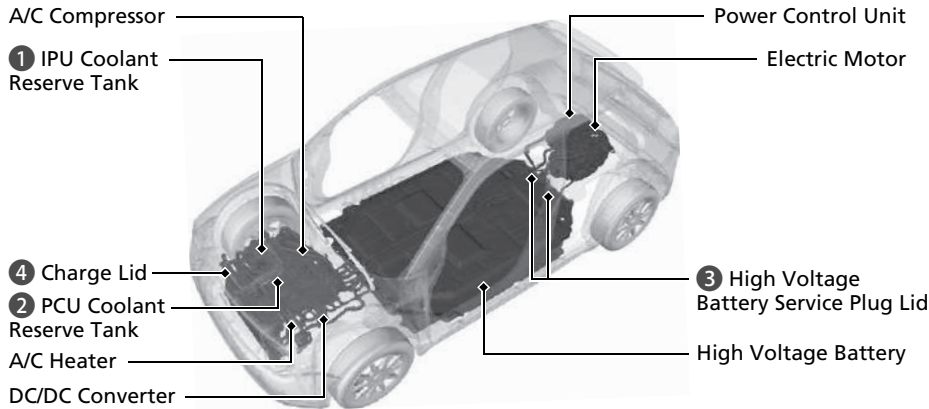

Label

- 1 IPU Coolant Reserve Tank
- 2 PCU Coolant Reserve Tank



- 3 High Voltage Battery Service Plug Lid



- 4 Charge Lid



⚠ WARNING

This vehicle has high voltage circuits and parts. Failure to observe the following precautions can result in burns or electric shock.

- Do not remove, disassemble, or replace the high voltage parts, cables (orange) or their connectors.
- Never touch the High Voltage battery service plugs.

In an emergency or during maintenance or repair, the service plugs are removed to cut off the electric flow from the battery. These plugs are in contact with the battery and can cause severe electric shock if not handled properly.

Only a qualified technician should handle any electrical equipment. For inspection and repair, consult a dealer.

High Voltage Battery

The High Voltage battery gradually discharges when the vehicle is not in use. If allowed to discharge too much, the battery may become damaged.

If your vehicle is parked for an extended period of time, during storage for example, periodically recharge the battery to maintain sufficient charge levels. At least once every three months, recharge the High Voltage battery.

Excessive heat can also damage the battery. On hot, sunny days, try to avoid parking your vehicle under direct sunlight.

If the High Voltage battery becomes fully discharged or damaged and you are unable to start the power system as a result, consult a dealer.

Temperature

When storing the vehicle, make sure not to expose it to extremely low temperatures:

If the temperature of the High Voltage battery drops to -30°C or below, the power system will not start. Wait for the High Voltage battery to warm up or move the vehicle to a warmer location. Note using the battery heating system will not help in this case.

Maintenance, Repair, and Disposal

Always consult a dealer regarding maintenance, repair, and disposal.

High Voltage batteries that have been removed from disposed vehicles are collected through a dealer. Do not dispose of these batteries yourself.

In Case of a Crash

- Be careful of electric shock hazard.
 - ▶ If a severe crash damaged your vehicle's High Voltage system, there is a possibility of electrical shock due to exposed High Voltage components or wires. If this happens, do not touch any of the High Voltage system components or any of its orange wires.
- Avoid contact with High Voltage battery fluid.
 - ▶ The High Voltage battery contains a flammable electrolyte that could leak as a result of a severe crash. Avoid any skin or eye contact with the electrolyte as it is corrosive. If you accidentally touch it, flush your eyes or skin with a large quantity of water for at least five minutes, and seek medical attention immediately.
- Use a fire extinguisher for an electrical fire.
 - ▶ Attempting to extinguish an electrical fire with a small quantity of water, from a garden hose for instance, can be dangerous.
- Anytime the vehicle is damaged in an accident, have it repaired by a dealer.

Emergency Shutdown System for the High Voltage System

The emergency shutdown system may activate when the vehicle is impacted by a crash or a collision. When this system activates, the High Voltage system automatically shuts down, and your vehicle no longer moves.

To return the High Voltage system to normal operation, consult a dealer.

WARNING

High voltage parts and/or the cables (orange) connecting them may be exposed as a result of a crash. Stay clear of these parts as you may be electrocuted.

If High Voltage battery fluid leaks, be careful not to touch the fluid. It can harm your eyes and skin. If it comes in contact with your eyes and skin; flush the affected area with clean water immediately for a few minutes, and seek immediate medical attention.

Regenerative Energy and Regenerative Braking

When decelerating or while driving downhill, the electric motor acts as a generator that recovers a portion of the electrical energy that was used to accelerate the vehicle.

In the following situations, the vehicle generates electricity while decelerating.

- The accelerator pedal is released with the shift position in **[D]**.
- The brake pedal is depressed with the shift position in **[D]**.
 - ▶ When the High Voltage battery is fully charged or its temperature is too cold/hot, or another factor or factors are affecting the condition of the battery, the regenerative braking system may not be activated.
- The deceleration paddle selector is used with the shift position in **[D]**.
 - ▶ You can control the rate of deceleration by using the deceleration paddle selector.

Safe Driving P.39

Airbags P.57

- Your vehicle is fitted with airbags to help to protect you and your passengers during a moderate-to-severe collision.

Child Safety P.75

- All children 12 and younger should be seated in the rear seat.
- Small children should be properly restrained in a front facing child restraint system.
- Infants must be properly restrained in a rear-facing child restraint system on a rear seat.

Seat Belts P.45

- Fasten your seat belt and sit upright well back in the seat.
- Check that your passengers are wearing their seat belts correctly.

Before Driving Checklist P.44

- Before driving, check that the front seats, head restraints, steering wheel, and mirrors have been properly adjusted.

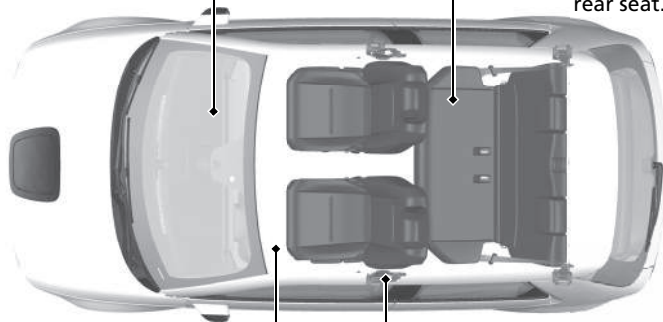

Fasten your lap belt as low as possible.

Instrument Panel [P.105](#)

Indicators [P.106](#) / Gauges [P.154](#) / Driver Information Interface [P.156](#)

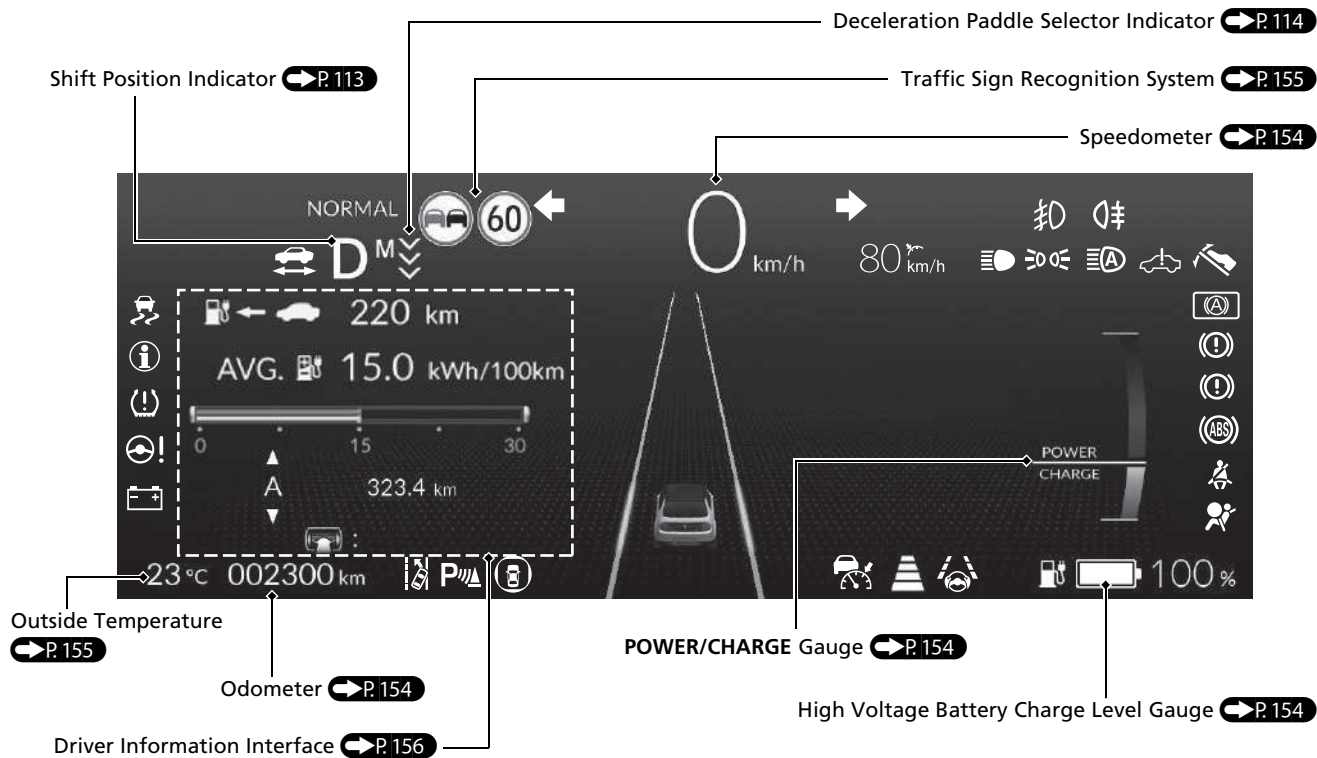

Controls P.171

Clock P.273

You can adjust the clock and customize the clock display.

 P.273

POWER Button P.197

Press the button to change the vehicle's power mode.

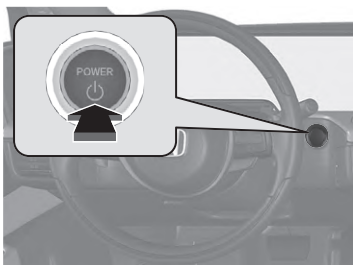

Turn Signals P.202

Turn Signal Control Lever

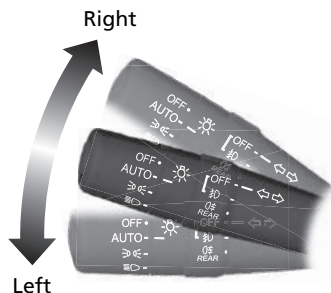

Lights P.201

Light Control Switches

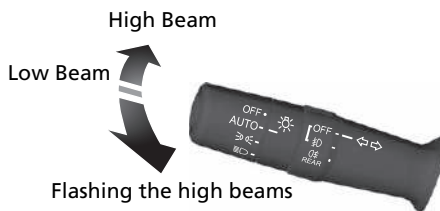

Wipers and Washers P.210

Wiper/Washer Control Lever

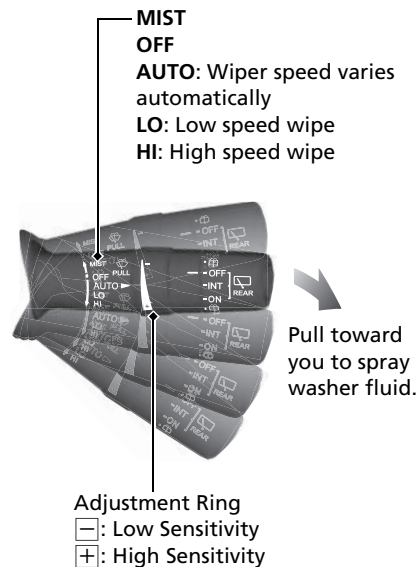

AUTO should always be turned **OFF** before the following situations in order to prevent severe damage to the wiper system:

- Cleaning the windscreen
- Driving through a car wash
- No rain present

Steering Wheel P.214

- To adjust, push the adjustment lever down, adjust to the desired position, then lock the lever back in place.

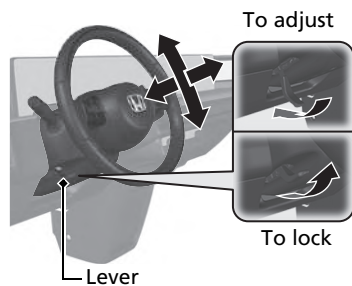

Unlocking the Front Doors from the Inside

 P.182

- Pull either front door inner handle to unlock and open it at the same time.
- When you open any door from inside the vehicle by using the inner handle, front door outer handles pop out.

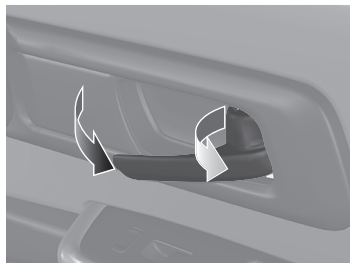

Tailgate P.186

- Press the outer handle to unlock and open the tailgate when you carry the keyless remote on you.

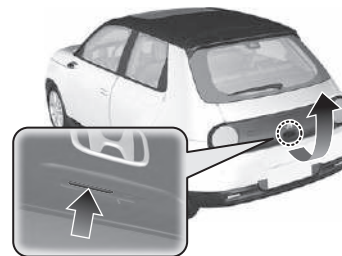

Side Camera Mirror System P.220

- With the power mode in ON, move the L/R selector switch to L or R.
- Push the appropriate edge of the adjustment switch to adjust the field of view.

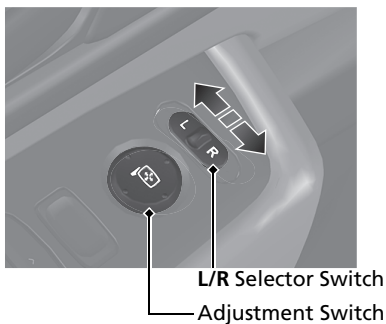



Power Windows P.194

- With the power mode in ON, open and close the power windows.
- If the power window lock button is in the off position, each passenger's window can be opened and closed with its own switch.
- If the power window lock button is in the on position (indicator on), each passenger's window switch is disabled.

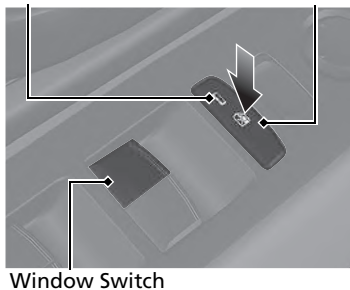
Indicator Power Window Lock Button



Climate Control System P.246

- Press the **AUTO** button to activate the climate control system.
- Press the  button to turn the system on or off.
- Press the  button to defrost the windscreen.

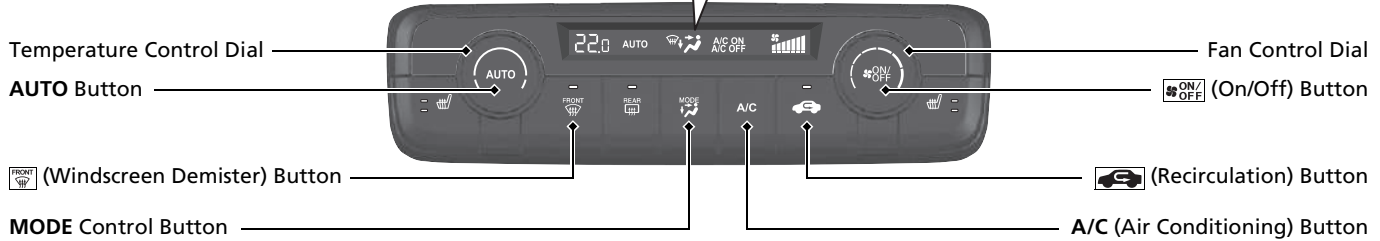
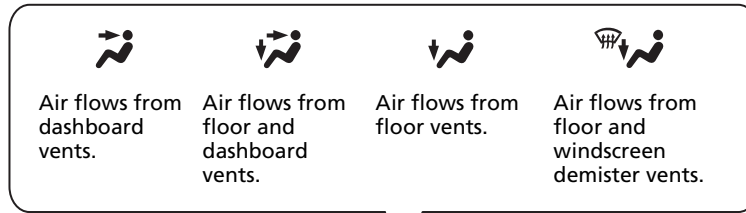

Features P.253

Audio System P. 256

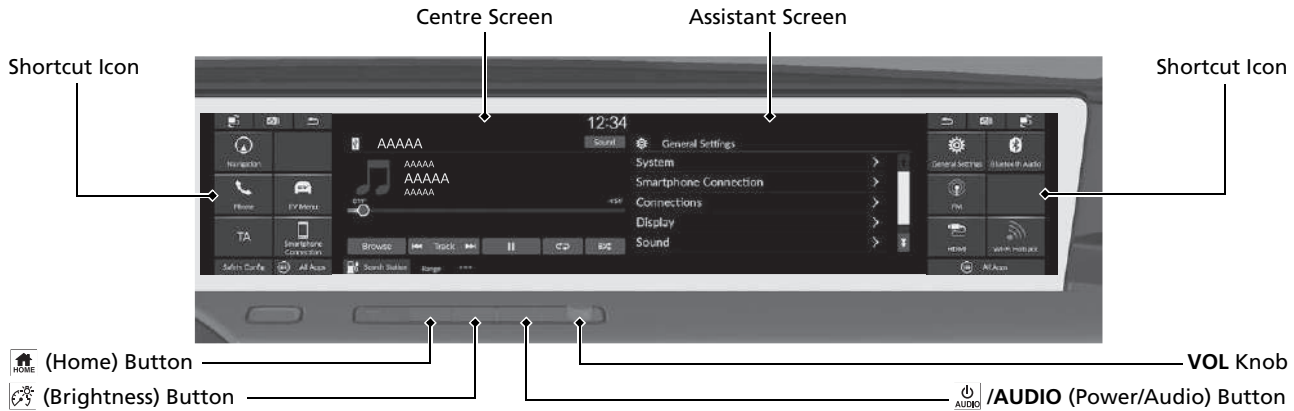



Audio Remote Controls

➔ P. 261

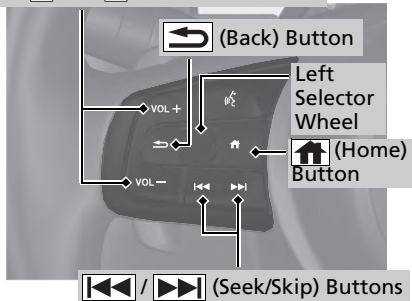
VOL+ / VOL- (Volume) Buttons



- **VOL+ / VOL-** (Volume) Buttons
Press to adjust the volume up/down.
- **Left Selector Wheel**
When selecting the audio mode
Press the  (home) button, then roll up or down to select  (audio) on the driver information interface, and then press the left selector wheel.

Roll up or down: To cycle through the audio modes, roll up or down and then press the left selector wheel:

FM/DAB/iPod/USB/Apple CarPlay/
Android Auto/*Bluetooth*® Audio/HDMI

Depending on a connected device, the displayed modes may be changed.

-  (Seek/Skip) Buttons
Radio: Press  to change the preset radio station.

iPod, USB drive, *Bluetooth*® Audio or Smartphone Connection:

Press  to skip to the beginning of the next song or return to the beginning of the current song.

Radio: Press and hold  to change the strong station.

USB drive:

Press and hold  to change a folder.

iPod: Press and hold  to change a song.

Depending on a connected device, the displayed modes may be changed.

Driving P. 373

Electronic Gear Selector P. 384

- Select **P** and depress the brake pedal when turning on the power.

Shift Operation

Shift Position Indicator

The shift position indicator and the shift button indicator indicate the current gear selection.



Shift Position Indicator

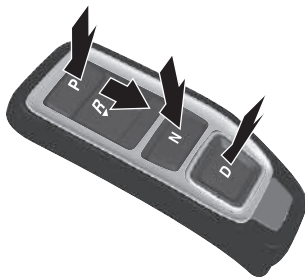
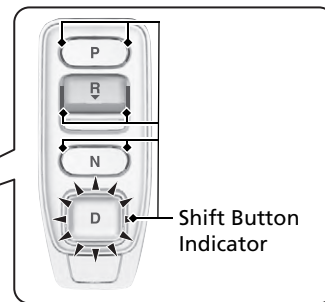
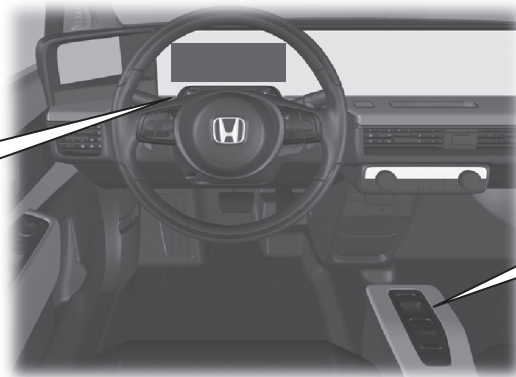

Parking

Press the **P** button.

Used when parking or before turning the power on or off.

Transmission is locked.



Reverse

Press back the **R** button.

Used when reversing.



Neutral

Press the **N** button.

Transmission is not locked.



Drive

Press the **D** button.

Used for normal driving.

When not use the single pedal control

The deceleration paddle selector can be used temporarily.

When use the single pedal control

The deceleration paddle selector can be used.

When you release the accelerator pedal, you can control the rate of deceleration without releasing your hands from the steering wheel. Using the deceleration paddle selector situated on the steering wheel, you can sequentially shift through four^{*1} or three^{*2} stages of deceleration.

- *1: When the Single Pedal Control is OFF
If you pull back the paddle selector, the rate of deceleration will change temporarily, and the stage will appear in the instrument panel.
- *2: When the Single Pedal Control is ON
If you pull back the paddle selector, the rate of deceleration will change and the stage along with **M** will appear in the instrument panel.

➤ Deceleration Paddle Selector ➔ P. 393

➤ Single Pedal Control ➔ P. 396



[-] Paddle Selector



[+] Paddle Selector

When the Single Pedal Control is OFF, the deceleration stage appears.



Deceleration Paddle Selector Indicator

When the Single Pedal Control is ON, the deceleration stage and **M** appear.



Deceleration Paddle Selector Indicator

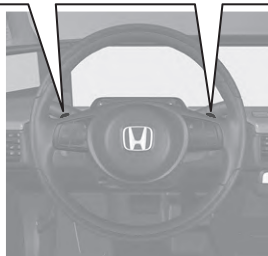

VSA On and Off ➔ P. 417

- The Vehicle Stability Assist (VSA) system helps stabilise the vehicle during cornering and helps maintain traction while accelerating on loose or slippery road surfaces.
- VSA comes on automatically every time you turn on the power system.
- To partially disable VSA functionality/features, press the  (VSA OFF) icon (green) in the safety config of the audio/information screen.

CMBS On and Off

➔ P. 322, 432

- When a possible collision is likely unavoidable, the CMBS can help you to reduce the vehicle speed and the severity of the collision.
- The CMBS is turned on every time you start the power system.
- To turn the CMBS on or off, use the audio/information screen or the safety support of the driver information interface.

Deflation Warning System P. 418

- Detects a change in tyre conditions and overall dimensions due to decrease in tyre pressures.
- The Deflation Warning System is turned on automatically every time you turn on the power system.
- A calibration procedure must be performed when certain conditions arise.

Adjustable Speed Limiter

 P. 403

- This system enables you to set a maximum speed that cannot be exceeded even if you are depressing the accelerator pedal.
- To use the adjustable speed limiter, press the  button. Select the adjustable speed limiter by pressing the **LIM** button, then press the **SET/-** button when your vehicle reaches the desired speed.
- The vehicle speed limit can be set from 30 km/h (18 mph) to 250 km/h (156 mph).

Honda Sensing ➔ P. 425

Honda Sensing is a driver support system which employs the use of three distinctly different kinds of sensors:

A radar sensor located in the front grille, a front sensor camera mounted to the interior side of the windshield, behind the rearview mirror, the sonar sensors located in the front and rear bumper.

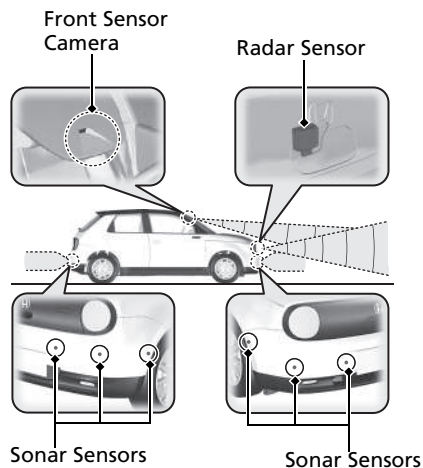

Collision Mitigation Braking System (CMBS) ➔ P. 428

Can assist you when there is a possibility of your vehicle colliding with a vehicle, pedestrian on foot or riding a bicycle (moving bicycle) detected in front of yours. The CMBS is designed to alert you when a potential collision is determined, as well as assist in reducing speed, avoiding collisions, and reducing collision severity.

Low Speed Braking Control ➔ P. 439

The Low Speed Braking Control system has three functions: Low Speed Brake function, Collision Mitigation Throttle Control, and Rear Collision Mitigation Throttle Control. Using sonar sensors located on the front and rear bumpers, the vehicle detects if there danger of collision with a wall or other obstacle when the accelerator is depressed with too much force, and the system assists in avoiding collisions and reducing damage from impact by limiting power system output.

Adaptive Cruise Control (ACC) with Low Speed Follow ➔ P. 445

Helps to maintain a constant vehicle speed and a set following-interval behind a vehicle detected ahead of yours and, if the detected vehicle comes to a stop, can decelerate and stop your vehicle, without you having to keep your foot on the brake or the accelerator.

Lane Keeping Assist System (LKAS) ➔ P. 465

Provides steering input to help keep the vehicle in the middle of a detected lane and provides tactile and visual alerts if the vehicle is detected drifting out of its lane.

Road Departure Mitigation System ➔ P. 476

Alerts and helps to assist you when the system detects a possibility of your vehicle unintentionally crossing over detected lane markings and/or leaving the roadway altogether.

Lead Car Departure Notification System

➔ P. 482

Informs you with visual and audible alerts when your vehicle is stopped even though the vehicle ahead of you has started moving.

Traffic Sign Recognition System ➔ P. 486

Reminds you of road sign information, such as the current speed limit and that overtaking is prohibited, your vehicle has just passed through, showing it on the gauge.

Maintenance [↔ P.571](#)

Under the Bonnet [↔ P.585](#)

- Check coolants and windscreen washer fluid. Add when necessary.
- Check brake fluid.
- Check the 12-volt battery condition monthly.

- 1 Pull the bonnet release handle under the corner of the dashboard.



- 2 Locate the bonnet latch lever, push it to the side, and then raise the bonnet. Once you have raised the bonnet slightly, you can release the lever.



- 3 When finished, close the bonnet and make sure it is firmly locked in place.

Wiper Blades [↔ P.598](#)

- Replace blades if they leave streaks across the windscreen.



Tyres [↔ P.603](#)

- Inspect tyres and wheels regularly.
- Check tyre pressures regularly.
- Install winter tyres for winter driving.

Lights [↔ P.594](#)

- Inspect all lights regularly.

Handling the Unexpected P.629

Flat Tyre P.630

- Park in a safe location and repair the flat tyre using the tyre repair kit.



Indicators Come On P.651

- Identify the indicator and consult the owner's manual.

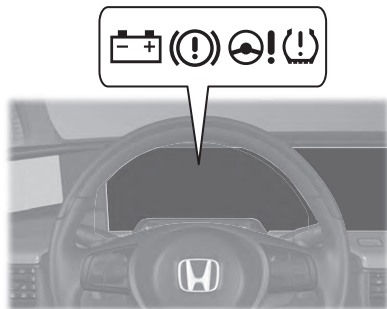

Power System Won't Start P.644

- If the 12-volt battery is dead, jump start using a booster battery.

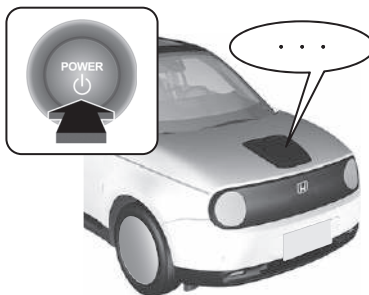

Blown Fuse P.658

- Check for a blown fuse if an electrical device does not operate.

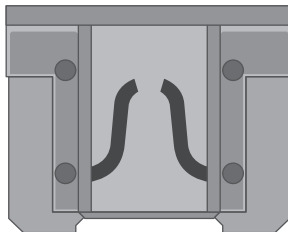

Overheating P.650

- Park in a safe location. If you do not see steam under the bonnet, open the bonnet, and let the power system cool down.



Emergency Towing P.667

- Call a professional towing service if you need to tow your vehicle.



What to Do If

Q Why does the brake pedal pulsate slightly when applying the brakes?

A This can occur when the ABS activates and does not indicate a problem. Apply firm, steady pressure on the brake pedal. Never pump the brake pedal.
➤ Anti-lock Brake System (ABS) ➔ P.504

Q The rear door cannot be opened from inside the vehicle. Why?

A Check if the childproof lock is in the lock position. If so, open the rear door with the outside door handle. To cancel this function, slide the lever up to the unlock position.



Q Why do the doors lock after I unlocked the doors?

A If you do not open the doors within 30 seconds, the doors are relocked automatically for security.

Q Why does the power mode suddenly turn on or off even though I haven't touched the power switch?

A Auto Power ON/OFF may be activated.
➤ Auto Power ON/OFF ➔ P.198



Why does the beeper sound when I open the driver's door?



The beeper sounds when:

- The power mode is in ACCESSORY.
- The exterior lights are left on.



Why does the beeper sound when I start driving?



The beeper sounds when the driver and/or front passenger are not wearing their seat belts.



Pressing the electric parking brake switch does not release the parking brake. Why?



Press the electric parking brake switch with the brake pedal depressed.



I'm seeing an amber indicator of a tyre with an exclamation point. What is that?



The Deflation Warning System needs attention. If you recently inflated or changed a tyre, you have to recalibrate the system.

➤ Deflation Warning System ➔ P.418



Depressing the accelerator pedal does not release the parking brake automatically. Why?



- Fasten the driver's seat belt.
- Check if the transmission is in **P** or **N**. If so, select any other position.



Why does the shift position automatically change to **P** when I open the driver's door to check for parking space lines when reversing?



- Fasten the driver's seat belt.
- Close the driver's door and manually change the shift position.
 - When opening the driver's door **P. 388**



Why do I hear a screeching sound when I apply the brake pedal?



The brake pads may need to be replaced. Have your vehicle inspected by a dealer.

Safe Driving

You can find many safety recommendations throughout this chapter, and throughout this manual.

For Safe Driving

Important Safety Precautions.....	40
Your Vehicle's Safety Features.....	43
Safety Checklist	44

Seat Belts

About Your Seat Belts.....	45
Fastening a Seat Belt.....	51
Seat Belt Inspection.....	55

Airbags

Airbag System Components.....	57
Types of Airbags.....	59
Front Airbags (SRS)	59

Side Airbags.....	65
Side Curtain Airbags.....	67
Airbag System Indicators.....	69
Airbag Care	71

Pop-up Hood System

About the Pop-up Hood System.....	72
Pop-up Hood System Care.....	74

Child Safety

Protecting Child Passengers	75
Safety of Infants and Small Children....	78
Safety of Larger Children	100

Safety Labels

Label Locations	103
-----------------------	-----

The following pages explain your vehicle's safety features and how to use them properly. The safety precautions below are ones that we consider to be among the most important.

Important Safety Precautions

■ Always wear your seat belt

A seat belt is your best protection in all types of collisions. Airbags are designed to supplement seat belts, not replace them. So even though your vehicle is equipped with airbags, make sure you and your passengers always wear your seat belts, and wear them properly.

■ Restrain all children

Children aged 12 and under should ride properly restrained in a back seat, not the front seat. Infants and small children should be restrained in a child restraint system. Larger children should use a booster seat and a lap/shoulder seat belt until they can use the belt properly without a booster seat.

■ Be aware of airbag hazards

While airbags can save lives, they can cause serious or fatal injuries to occupants who sit too close to them, or are not properly restrained. Infants, young children, and short adults are at the greatest risk. Be sure to follow all instructions and warnings in this manual.

■ Don't drink and drive

Alcohol and driving don't mix. Even one drink can reduce your ability to respond to changing conditions, and your reaction time gets worse with every additional drink. So don't drink and drive, and don't let your friends drink and drive, either.

▣ Important Safety Precautions

Some countries prohibit the use of mobile phones other than hands-free devices by the driver while driving.

■ Pay appropriate attention to the task of driving safely

Engaging in mobile phone conversation or other activities that keep you from paying close attention to the road, other vehicles, and pedestrians could lead to a crash. Remember, situations can change quickly, and only you can decide when it is safe to divert some attention away from driving.

■ Control your speed

Excessive speed is a major factor in crash injuries and deaths. Generally, the higher the speed, the greater the risk, but serious injuries can also occur at lower speeds. Never drive faster than is safe for current conditions, regardless of the maximum speed posted.

■ Keep your vehicle in safe condition

Having a tyre blowout or a mechanical failure can be extremely hazardous. To reduce the possibility of such problems, check your tyre pressures and condition frequently, and perform all regularly scheduled maintenance.

■ Do not leave children unattended in the vehicle

Children, pets and people needing assistance left unattended in the vehicle may be injured if they activate one or more of the vehicle controls. They may also cause the vehicle to move, resulting in a crash in which they and/or another person(s) can be injured or killed. Also, depending on the ambient temperature, the temperature of the interior may reach extreme levels, which can result in harm or death. Even if the climate control system is on, never leave them in the vehicle unattended as the climate control system can shut off at any time.

■ **Handle high-voltage with care**

Familiarise yourself with the charging instructions and warnings supplied in this manual. If using a public charger, also observe the charging station manufacturer's instructions.

Your Vehicle's Safety Features

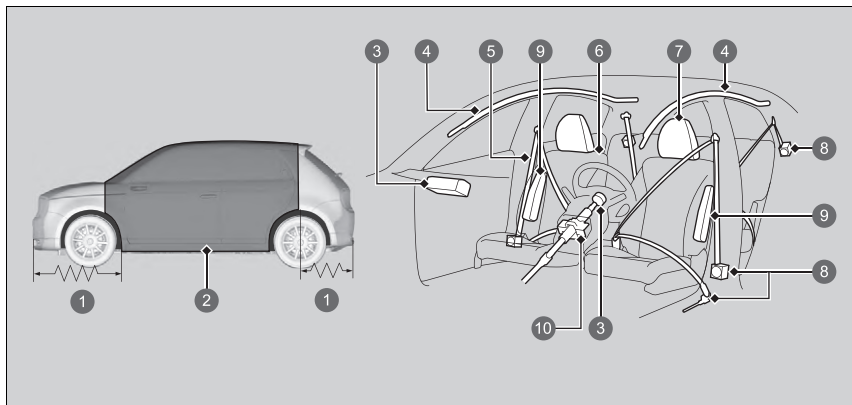

- ① Crush Zones
- ② Safety Cage
- ③ Front Airbags
- ④ Side Curtain Airbags
- ⑤ Seat Belts
- ⑥ Seats and Seat-Backs
- ⑦ Head Restraints
- ⑧ Seat Belt Tensioners
- ⑨ Side Airbags
- ⑩ Collapsible Steering Column

The following checklist will help you take an active role in protecting yourself and your passengers.

☒ Your Vehicle's Safety Features

Your vehicle is equipped with many features that work together to help to protect you and your passengers during a crash.

Some features do not require any action on your part. These include a strong steel framework that forms a safety cage around the passenger compartment, front and rear crush zones, a collapsible steering column, and tensioners that tighten the front and rear seat belts in a sufficient crash.

However, you and your passengers cannot take full advantage of these features unless you remain seated in the correct position and always wear your seat belts. In fact, some safety features can contribute to injuries if they are not used properly.

Safety Checklist

For the safety of you and your passengers, make a habit of checking these items each time before you drive. Check if the charging cable is connected to the vehicle and disconnect it if it is. The vehicle will not operate with the cable connected.

- Adjust your seat to a position suitable for driving. Be sure the front seats are adjusted as far to the rear as possible while allowing the driver to control the vehicle. Sitting too close to a front airbag can result in serious or fatal injury in a crash.
 - ▣ **Seats** P. 226
- Adjust head restraints to the proper position. Head restraints are most effective when the centre of the head restraint aligns with the centre of your head. Taller persons should adjust their head restraint to the highest position.
 - ▣ **Adjusting the Front Head Restraint Positions** P. 231
- Always wear your seat belt, and make sure you wear it properly. Confirm that any passengers are properly belted as well.
 - ▣ **Fastening a Seat Belt** P. 51
- Protect children by using seat belts or child restraint systems according to a child's age, height and weight.
 - ▣ **Child Safety** P. 75

▣ Safety Checklist

If the door and/or tailgate open message appears on the driver information interface, a door and/or the tailgate is not completely closed. Close all doors and the tailgate tightly until the message disappears.

▣ **Driver Information Interface Warning and Information Messages** P. 130

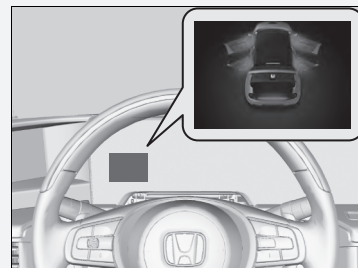

About Your Seat Belts

Seat belts are the single most effective safety device because they keep you connected to the vehicle so that you can take advantage of many built-in safety features. They also help to keep you from being thrown against the inside of the vehicle, against any passengers, or out of the vehicle. When worn properly, seat belts also keep your body properly positioned in a crash so that you can take full advantage of the additional protection provided by the airbags.

In addition, seat belts help to protect you in almost every type of crash, including:

- frontal impacts
- side impacts
- rear impacts
- rollovers

⌘ About Your Seat Belts

⚠ WARNING

Not wearing a seat belt properly increases the chance of serious injury or death in a crash, even though your vehicle has airbags.

Be sure you and your passengers always wear seat belts and wear them properly.

WARNING: Seat belts are designed to bear upon the bony structure of the body, and should be worn low across the front of the pelvis or the pelvis, chest and shoulders, as applicable; wearing the lap section of the belt across the abdominal area must be avoided.

WARNING: Seat belts should be adjusted as firmly as possible, consistent with comfort, to provide the protection for which they have been designed. A slack belt will greatly reduce the protection afforded to the wearer.

WARNING: Belts should not be worn with straps twisted.

WARNING: Each belt assembly must only be used by one occupant; it is dangerous to put a belt around a child being carried on the occupant's lap.

■ Lap/shoulder seat belts

All four seating positions are equipped with lap/shoulder seat belts with emergency locking retractors. In normal driving the retractor lets you move freely while keeping some tension on the belt. During a collision or sudden stop the retractor locks to restrain your body.

The seat belt must be properly secured when using a front-facing child restraint system.

➤ **Child Safety** P. 75

➤ About Your Seat Belts

If you extend the seat belt too quickly, it will lock in place. If this happens, slightly retract the seat belt, then extend it slowly.

Seat belts cannot completely protect you in every crash. But in most cases, seat belts can reduce your risk of serious injury.

Most countries require you to wear seat belts. Take time to familiarise with the legal requirements of the countries in which you will drive.

■ Proper use of seat belts

Follow these guidelines for proper use:

- All occupants should sit upright, well back in the seat, and remain in that position for the duration of the trip. Slouching and leaning reduce the effectiveness of the belt and can increase the chance of serious injury in a crash.
- Never place the shoulder part of a lap/shoulder seat belt under your arm or behind your back. This could cause very serious injuries in a crash.
- Two people should never use the same seat belt. If they do, they could be very seriously injured in a crash.
- Do not put any accessories on the seat belts. Devices intended to improve comfort or reposition the shoulder part of a seat belt can reduce the protective capability and increase the chance of serious injury in a crash.

■ Seat Belt Reminder

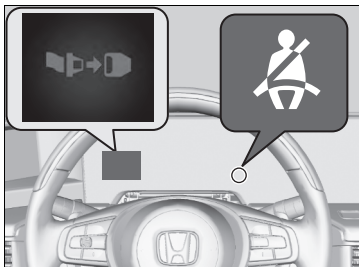

■ Front seats

The seat belt system includes an indicator on the instrument panel to remind the driver or a front passenger or both to fasten their seat belts.

If you set the power mode to ON and a seat belt is not fastened, the indicator will come on.

The beeper will periodically sound and the indicator will blink if you start driving without fastening a seat belt.

▶▶ Seat Belt Reminder

The indicator will also come on if a front passenger does not fasten their seat belt within six seconds after the power mode is set to ON.

When no one is sitting in the front passenger's seat, the indicator will not come on and the beeper will not sound.

If the indicator comes on or the beeper sounds with no one sitting in the front passenger's seat. Check if:

- There is nothing heavy placed on the front passenger seat.
- The driver's seat belt is fastened.

If the indicator does not light when the passenger is seated and is not fastened, something may be interfering with the occupant detection sensor. Check if:

- A cushion is placed on the seat.
- The front passenger is not sitting properly.

If none of these conditions exist, have your vehicle checked by a dealer.

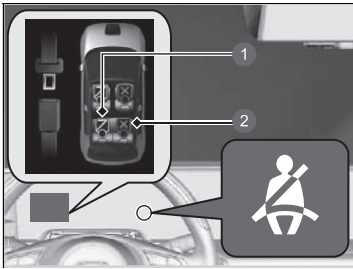

- ① Fastened
- ② Unfastened

■ Rear seats

Your vehicle monitors rear seat belt use. A driver information interface notifies you if any of the rear seat belts are not used with a seating position occupied.

The display appears when:

- A rear door is opened and closed.
- Any of the rear passengers fastened or unfastened their seat belt.

The indicator blinks and beeper sounds if any rear passenger's seat belt is unfastened while driving.

▣ Seat Belt Reminder

When the luggage is loaded on the rear seats and the sensor detects the weight, the warning indicator may blink and the beeper may sound.

The sensor may not detect a passenger and not work properly if a child or small person is sitting in or a cushion is placed on the rear seats.

Do not fold down the seat-back with leaving luggage on the rear seats.

The sensor may not work properly or be broken.

If none of these conditions exist, have your vehicle checked by a dealer.

■ Automatic Seat Belt Tensioners

The front seats and the rear seats are equipped with automatic seat belt tensioners to enhance safety.

The tensioners automatically tighten the front seat belts and the rear seat belts during a moderate-to-severe frontal collision, sometimes even if the collision is not severe enough to inflate the front airbags.

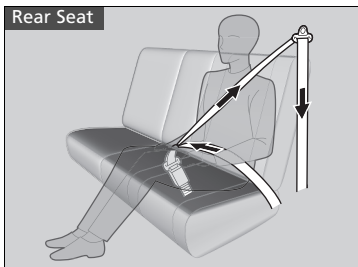
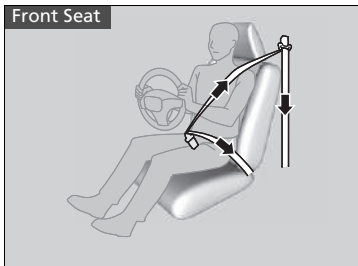

▶ Automatic Seat Belt Tensioners

The seat belt tensioners can only operate once. If a tensioner is activated, the SRS indicator will come on. Have a dealer replace the tensioner and thoroughly inspect the seat belt system as it may not offer protection in a subsequent crash.

During a moderate-to-severe side impact, the tensioner on that side of the vehicle also activates.

Fastening a Seat Belt

After adjusting a front seat to the proper position, and while sitting upright and well back in the seat (see illustrations for correct seating posture):

📖 **Seats** P. 226



1. Pull the seat belt out slowly.

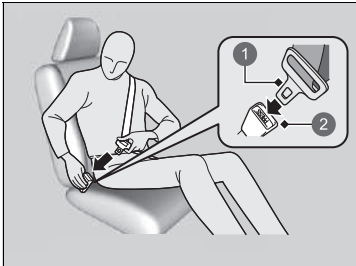

2. Insert the latch plate into the buckle, then tug on the belt to make sure the buckle is secure.

▶ Make sure that the belt is not twisted or caught on anything.

① Latch Plate

② Buckle

📖 Fastening a Seat Belt

No one should sit in a seat with an inoperative seat belt or one that does not appear to be working correctly. Using a seat belt that is not working properly may not protect the occupant in a crash. Have a dealer check the belt as soon as possible.

If the seat belt appears to be locked in a fully retracted position, firmly pull out on the shoulder belt once, then push it back in.

Then smoothly pull it out of the retractor and fasten. If you are unable to release the seat belt from a fully retracted position, do not allow anyone to sit in the seat, and take your vehicle to a dealer for repair.

📖 **About Your Seat Belts** P. 45

📖 **Seat Belt Inspection** P. 55



3. Position the lap part of the belt as low as possible across your hips (see illustration), then pull up on the shoulder part of the belt so the lap part fits snugly. This lets your strong pelvic bones take the force of a crash and reduces the chance of internal injuries.
4. If necessary, pull up on the belt again to remove any slack, then check that the belt rests across the centre of your chest and over your shoulder. This spreads the forces of a crash over the strongest bones in your upper body.

Fastening a Seat Belt

⚠ WARNING

Improperly positioning the seat belts can cause serious injury or death in a crash.

Make sure all seat belts are properly positioned before driving.

To release the belt, push the red **PRESS** button and then guide the belt by hand until it has retracted completely.

When exiting the vehicle, be sure the belt is properly stowed so that it will not get caught in the closing door.

Never insert any foreign objects into the buckle or retractor mechanism.

■ Adjusting the Shoulder Anchor

The front seats have adjustable shoulder anchors to accommodate taller and shorter occupants.

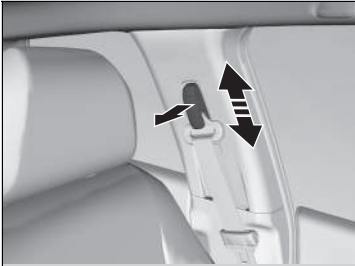

1. Move the anchor up and down while pulling the shoulder anchor outward.
2. Position the anchor so that the belt rests across the centre of your chest and over your shoulder.

▣ Adjusting the Shoulder Anchor

After an adjustment, make sure that the shoulder anchor position is secure.

The shoulder anchor height can be adjusted to four levels. If the belt contacts your neck, lower the height one level at a time.

■ Advice for Pregnant Women

Consider alternative:

If you are pregnant, the best way to protect yourself and your unborn child when driving or riding in a vehicle is to always wear a seat belt. When positioning the seat belt, wear the shoulder belt section across the chest, avoiding the abdomen, and keep the lap belt portion as low as possible across the hips. (See illustration.)



▣ Advice for Pregnant Women

Each time you have a checkup, ask your doctor if it is okay for you to drive.

To reduce the risk of injuries to both you and your unborn child that can be caused by an inflating front airbag:

- When driving, sit upright and adjust the seat as far back as possible while allowing full control of the vehicle.
- When sitting in the front passenger's seat, adjust the seat as far back as possible.

Seat Belt Inspection

Regularly check the condition of your seat belts as follows:

- Pull each belt out fully, and look for frays, cuts, burns, and wear.
- Check that the latch plates and buckles work smoothly and the belts retract easily.
 - ▶ If a belt does not retract easily, cleaning the belt may correct the problem. Only use a mild soap and warm water. Do not use bleach or cleaning solvents. Make sure the belt is completely dry before allowing it to retract.

Any belt that is not in good condition or working properly will not provide proper protection and should be replaced as soon as possible.

A belt that has been worn during a crash may not provide the same level of protection in a subsequent crash. Have your seat belts inspected by a dealer after any collision.

▶▶ Seat Belt Inspection

⚠ WARNING

Not checking or maintaining seat belts can result in serious injury or death if the seat belts do not work properly when needed.

Check your seat belts regularly and have any problem corrected as soon as possible.

WARNING: No modifications or additions should be made by the user which will either prevent the seat belt adjusting devices from operating to remove slack, or prevent the seat belt assembly from being adjusted to remove slack.

WARNING: It is essential to replace the entire assembly after it has been worn in a severe impact even if damage to the assembly is not obvious.

WARNING: Care should be taken to avoid contamination of the webbing with polishes, oils and chemicals, and particularly battery acid. Cleaning may safely be carried out using mild soap and water. The belt should be replaced if webbing becomes frayed, contaminated or damaged.

Anchorage Points

Front Seat



When replacing the seat belts, use the anchorage points shown in the images. The front seat has a lap/shoulder belt.

Rear Seat



The rear seat has two lap/shoulder belts.

Airbag System Components

The front, front side, and side curtain airbags are deployed according to the direction and severity of impact. The airbag system includes:

- Two SRS (Supplemental Restraint System) front airbags. The driver's airbag is stored in the centre of the steering wheel; the front passenger's airbag is stored in the dashboard. Both are marked **SRS AIRBAG**.
- Two side airbags, one for the driver and one for a front passenger. The airbags are stored in the outer edges of the seat-backs. Both are marked **SIDE AIRBAG**.
- Two side curtain airbags, one for each side of the vehicle. The airbags are stored in the ceiling, above the side windows. The front pillars and roof lining are marked **SIDE CURTAIN AIRBAG**.
- An electronic control unit that, when the power mode is in ON, continually monitors information about the various impact sensors, seat and buckle sensors, airbag activators, seat belt tensioners, and other vehicle information. During a crash event the unit can record such information.
- Automatic seat belt tensioners for the front seats and rear seats.
- Impact sensors that can detect a moderate-to-severe front or side impact.
- An indicator on the instrument panel that alerts you to a possible problem with your airbag system or seat belt tensioners.
- An indicator on the roof console that alerts you that the front passenger's front airbag has been turned off.

■ Important Facts About Your Airbags

Airbags can pose serious hazards. To do their job, airbags must inflate with tremendous force. So, while airbags help to save lives, they can cause burns, bruises, and other minor injuries, sometimes even fatal ones if occupants are not wearing their seat belts properly and sitting correctly.

What you should do: Always wear your seat belt properly, and sit upright and as far back from the steering wheel as possible while allowing full control of the vehicle. A front passenger should move their seat as far back from the dashboard as possible.

Remember, however, that no safety system can prevent all injuries or deaths that can occur in a severe crash, even when seat belts are properly worn and the airbags deploy.

Do not place hard or sharp objects between yourself and a front airbag.

Carrying hard or sharp objects on your lap, or driving with a pipe or other sharp object in your mouth, can result in injuries if your front airbag inflates.

Do not attach or place objects on the front airbag covers. Objects on the covers marked **SRS AIRBAG** could interfere with the proper operation of the airbags or be propelled inside the vehicle and hurt someone if the airbags inflate.

▣ Important Facts About Your Airbags

Do not attempt to deactivate your airbags. Together, airbags and seat belts provide the best protection.

When driving, keep hands and arms out of the deployment path of the front airbag by holding each side of the steering wheel. Do not cross an arm over the airbag cover.

Types of Airbags

Your vehicle is equipped with three types of airbags:

- **Front airbags:** Airbags in front of the driver's and front passenger's seats.
- **Side airbags:** Airbags in the driver's and front passenger's seat-backs.
- **Side curtain airbags:** Airbags above the side windows.

Each is discussed in the following pages.

Front Airbags (SRS)

The front SRS airbags inflate in a moderate-to-severe frontal collision to help to protect the head and chest of the driver and/or front passenger.

SRS (Supplemental Restraint System) indicates that the airbags are designed to supplement seat belts, not replace them. Seat belts are the occupant's primary restraint system.

■ Housing Locations

The front airbags are housed in the centre of the steering wheel for the driver, and in the dashboard for the front passenger. Both airbags are marked **SRS AIRBAG**.

☒ Types of Airbags

The airbags can inflate whenever the power mode is in ON.

After an airbag inflates in a crash, you may see a small amount of smoke. This is from the combustion process of the inflator material and is not harmful. People with respiratory problems may experience some temporary discomfort. If this occurs, get out of the vehicle as soon as it is safe to do so.

■ Operation

Front airbags are designed to inflate during moderate-to-severe frontal collisions. When the vehicle decelerates suddenly, the sensors send information to the control unit which signals one or both front airbags to inflate.

A frontal collision can be either head-on or angled between two vehicles, or when a vehicle crashes into a stationary object, such as a concrete wall.

■ How the Front Airbags Work

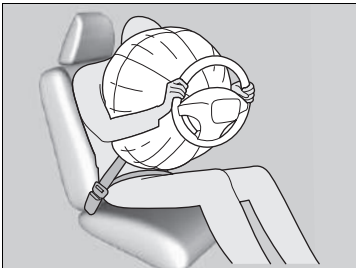

While your seat belt restrains your torso, the front airbag provides supplemental protection for your head and chest. The front airbags deflate immediately so that they won't interfere with the driver's visibility or the ability to steer or operate other controls.

The total time for inflation and deflation is so fast that most occupants are not aware that the airbags deployed until they see them lying in front of them.

■ When front airbags should not deploy

Minor frontal crashes: Front airbags were designed to supplement seat belts and help to save lives, not to prevent minor scrapes, or even broken bones that might occur during a less than moderate-to-severe frontal crash.

Side impacts: Front airbags can provide protection when a sudden deceleration causes a driver or front passenger to move towards the front of the vehicle. Side airbags and side curtain airbags have been specifically designed to help to reduce the severity of injuries that can occur during a moderate-to-severe side impact which can cause the driver or passenger to move towards the side of the vehicle.

Rear impacts: Head restraints and seat belts are your best protection during a rear impact. Front airbags cannot provide any significant protection and are not designed to deploy in such collisions.

Rollovers: Seat belts and side curtain airbags offer the best protection in a rollover. Because front airbags could provide little if any protection, they are not designed to deploy during a rollover.

■ When front airbags deploy with little or no visible damage

Because the airbag system senses sudden deceleration, a strong impact to the vehicle framework or suspension might cause one or more of the airbags to deploy. Examples include running into a curb, the edge of a hole, or other low fixed object that causes a sudden deceleration in the vehicle chassis. Since the impact is underneath the vehicle, damage may not be readily apparent.

■ When front airbags may not deploy, even though exterior damage appears severe

Since crushable body parts absorb crash energy during an impact, the amount of visible damage does not always indicate proper airbag operation. In fact, some collisions can result in severe damage but no airbag deployment because the airbags would not have been needed or would not have provided protection even if they had deployed.

▶▶ Passenger Front Airbag Off System

If it is unavoidable to install a rear-facing child restraint system in the front passenger seat, you must manually deactivate the passenger front airbag system, using the built-in key.

▶▶ Passenger front airbag ON/OFF switch

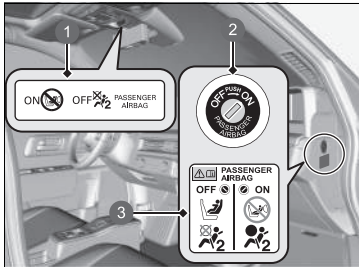

- 1 Passenger Front Airbag **ON/OFF** Indicator
- 2 **ON/OFF** Switch
- 3 System Warning Label

When the passenger front airbag **ON/OFF** switch is in:

OFF: The passenger front airbag is deactivated. The passenger front airbag does not inflate during a frontal crash that inflates driver's front airbag.

The passenger front airbag off indicator stays on as a reminder.

ON: The passenger front airbag is activated. The passenger front airbag on indicator comes on and remains on for about 65 seconds.

▶▶ Passenger Front Airbag Off System

⚠ WARNING

The passenger front airbag system must be turned off, if it is not avoidable to put a rear-facing child restraint system in the front passenger seat.

If the front passenger airbag inflates, it can hit the rear-facing child restraint system with enough force to kill or cause a very serious injury to the infant.

⚠ WARNING

Make sure to turn on the passenger front airbag system when a rear-facing child restraint system is not used on the front passenger seat.

Leaving the passenger front airbag system deactivated can result in serious injury or death in a crash.

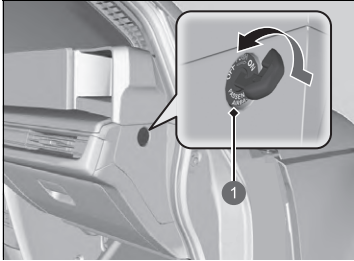
■ To deactivate the passenger front airbag system

1 Passenger Front Airbag **ON/OFF** Switch

1. Set the parking brake, and set the power mode to VEHICLE OFF.
2. Open the front passenger's door.
3. Insert the built-in key to the passenger front airbag **ON/OFF** switch.
 - ▶ The switch is located at the side panel of the front passenger side instrument panel.
4. Turn the built-in key to **OFF**, and remove it from the switch.

■ Passenger front airbag off indicator

When the passenger front airbag system is activated, the indicator goes off after a few seconds when you set the power mode is in ON.

When the passenger front airbag system is deactivated, the indicator stays on, or goes off momentarily and comes back on.

■ Passenger front airbag off system label

The label is located at the side panel of the front passenger side instrument panel.



- ① Infant in a rear-facing child restraint system: May ride in front if it is unavoidable
- ② Cannot be seated in front
- ③ Passenger front airbag is: Active
- ④ Inactive

▶▶ To deactivate the passenger front airbag system

NOTICE

- Use your vehicle's built-in key to turn the passenger front airbag **ON/OFF** switch. If you use a different key, the switch can be damaged, or the passenger front airbag system may not work properly.
- Do not close the door or apply an excessive load on the built-in key while the key is in the passenger front airbag **ON/OFF** switch. The switch or the key can be damaged.

We strongly recommend that you do not install a rear-facing child restraint system in the front passenger seat.

▶▶ Protecting Infants P. 78

It is your responsibility to change the setting of the passenger front airbag system to **OFF** when you put a rear-facing child restraint system on the front passenger seat.

When a rear-facing child restraint system is not in use in the front passenger seat, turn the system back on.

Side Airbags

The side airbags help to protect the torso and pelvis of the driver or a front passenger during a moderate-to-severe side impact.

Housing Locations

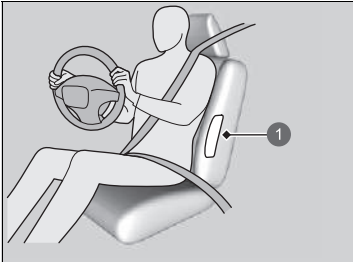

① Side Airbag Location

The side airbags are housed in the outside edge of the driver's and passenger's seat-backs.

Both are marked **SIDE AIRBAG**.

Side Airbags

Do not attach accessories on or near the side airbags. They can interfere with the proper operation of the airbags, or hurt someone if an airbag inflates.

■ Operation

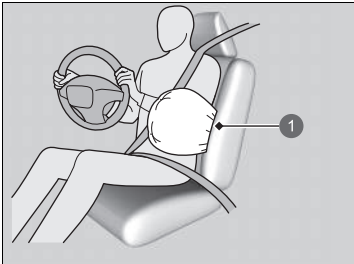

① Deployed Side Airbag

When the sensors detect a moderate-to-severe side impact, the control unit signals the side airbag on the impact side to immediately inflate.

■ When a side airbag deploys with little or no visible damage

Because the airbag system senses sudden acceleration, a strong impact to the side of the vehicle's framework can cause a side airbag to deploy. In such cases, there may be little or no damage, but the side impact sensors detected a severe enough impact to deploy the airbag.

■ When a side airbag may not deploy, even though visible damage appears severe

It is possible for a side airbag not to deploy during an impact that results in apparently severe damage. This can occur when the point of impact was towards the far front or rear of the vehicle, or when the vehicle's crushable body parts absorbed most of the crash energy. In either case, the side airbag would not have been needed nor provided protection even if it had deployed.

⌘ Side Airbags

Do not cover or replace the front seat-back covers without consulting a dealer. Improperly replacing or covering front seat-back covers can prevent your side airbags from properly deploying during a side impact.

Do not let the front passenger lean sideways with their head in the deployment path of the side airbag. An inflating side airbag can strike with strong force and seriously injure the passenger.

Side Curtain Airbags

The side curtain airbags help to protect the heads of the driver and any passengers during a moderate-to-severe side impact.

■ Housing Locations

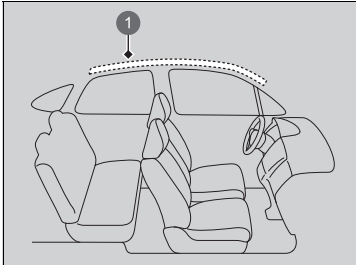

① Side Curtain Airbag Location

The side curtain airbags are located in the ceiling above the side windows on both sides of the vehicle.

⌘ Side Curtain Airbags

The side curtain airbags are most effective when an occupant is wearing their seat belt properly and sitting upright, well back in their seat.

Do not attach any objects to the side windows or roof pillars as they can interfere with the proper operation of the side curtain airbags.

■ Operation

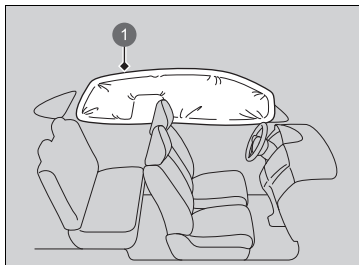

The side curtain airbag is designed to deploy in a moderate-to-severe side impact.

① Deployed Side Curtain Airbag

■ When side curtain airbags deploy in a frontal collision

One or both side curtain airbags may also inflate in a moderate-to-severe angled frontal collision.

Airbag System Indicators

If a problem occurs in the airbag system, the SRS indicator will come on and a message appears on the driver information interface.

Supplemental Restraint System (SRS) Indicator

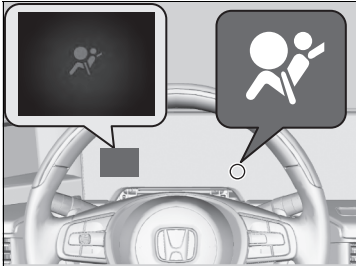

■ When the power mode is set to ON

The indicator comes on for a few seconds, then goes off. This tells you the system is working properly.

If the indicator comes on at any other time, or does not come on at all, have the system checked by a dealer as soon as possible. If you don't, your airbags and seat belt tensioners may not work properly when they are needed.

Supplemental Restraint System (SRS) Indicator

⚠ WARNING

Ignoring the SRS indicator can result in serious injury or death if the airbag systems or tensioners do not work properly.

Have your vehicle checked by a dealer as soon as possible if the SRS indicator alerts you to a possible problem.

⚠ WARNING

Remove the rear-facing child restraint system immediately from the front passenger seat if the SRS indicator comes on. Even if the passenger front airbag has been deactivated, do not ignore the SRS indicator.

The SRS system may have a fault which could cause the passenger front airbag to be activated, causing serious injury or death.

■ Passenger Front Airbag Off Indicator

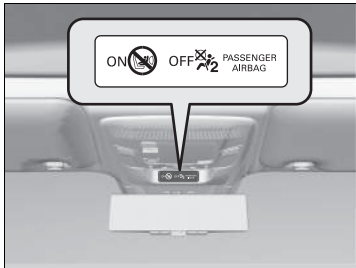

■ When the passenger airbag off indicator comes on

The indicator stays on while the passenger's front airbag system is deactivated.

When a rear-facing child restraint system is not in use in the front passenger seat, manually turn the system back on. The indicator should go off.

Airbag Care

You do not need to, and should not, perform any maintenance on or replace any airbag system components yourself. However, you should have your vehicle inspected by a dealer in the following situations:

■ When the airbags have deployed

If an airbag has inflated, the control unit and other related parts must be replaced. Similarly, once an automatic seat belt tensioner has been activated, it must be replaced.

■ When the vehicle has been in a moderate-to-severe collision

Even if the airbags did not inflate, have your dealer inspect the following: the seat belt tensioners for the front seats and rear seats, and each seat belt that was worn during the crash.

⚠ Airbag Care

The removal of airbag components from the vehicle is prohibited.

In case of malfunction, or shutdown, or after the airbag inflation/seat belt tensioner operation, ask a qualified personnel for handling.

We recommend against the use of salvaged airbag system components, including the airbag, tensioners, sensors, and control unit.

About the Pop-up Hood System

The pop-up hood system is designed to help to reduce the possible head injuries of a pedestrian if they experience a frontal impact with your vehicle.

■ The system activates when

Your vehicle strikes a pedestrian or other objects at moderate or higher speed.

■ How the system works

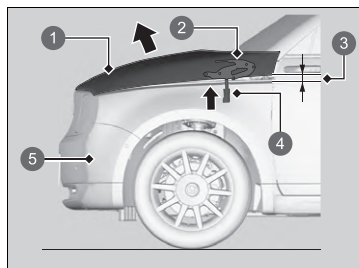

- 1 Bonnet
- 2 Hinge
- 3 Raises about 100 mm
- 4 Power Unit Component
- 5 Pedestrian Impact Sensors

When the pedestrian impact sensors detect a certain amount of impact, the pop-up hood system is activated and the rear of the bonnet will raise.

The raised bonnet can help to reduce pedestrian head injuries.

The power units are located in the vehicle front side of the hinges.

ⓘ About the Pop-up Hood System

⚠ WARNING

After the pop-up hood is activated, the power unit components become extremely hot and can cause burns. Do not touch the power unit components until they have cooled.

NOTICE

Do not attempt to open the bonnet after the pop-up hood system has been activated. After the system activation, make sure the raised bonnet does not interfere with visibility, and then drive slowly and carefully.

If the bonnet is not fully closed, it may not work properly. Make sure the bonnet is fully closed before driving.

The following conditions may also activate the system.

- A severe impact on the underside of your vehicle.
- Driving over speed bumps at high speed, or over a large pothole.
- When the objects impact the pedestrian impact sensors.

The system may not activate if your vehicle is:

- Impacted from the rear or side.
- Tipped over or rolled over.
- A pedestrian is struck at an angle.

Other factors, such as where, at which angle, or at what vehicle speed the impact has occurred, may prevent the pop-up hood system from activating.

▣ About the Pop-up Hood System

For the pop-up hood system to work properly:

- Always use the same size tyres as the original. The system may not read your vehicle speed correctly with the different size tyres.
- Never apply force to the system's power unit. It can be damaged if you slam the bonnet shut.
- Do not impact the pedestrian impact sensors in the front bumper.

Pop-up Hood System label is found under the bonnet:

▣ **Label Locations** P. 103

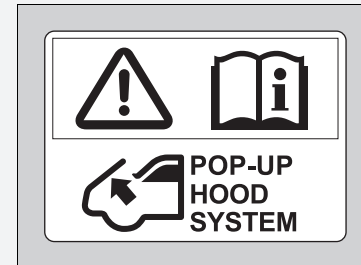

■ System Warning Message for Pop-up Hood

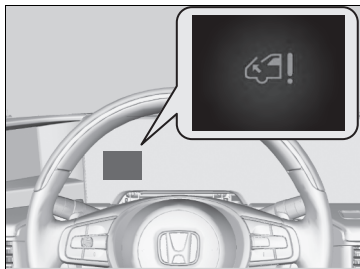

■ When the power mode is set to ON

A system warning message appears on the driver information interface if there is a potential problem with the pop-up hood system.

Pop-up Hood System Care

You do not need to, and should not, perform any maintenance on or replace any pop-up hood system components yourself.

However, if the pop-up hood system has ever activated, you need to have the control unit, and other related parts replaced by a dealer.

⌘ System Warning Message for Pop-up Hood

⚠ WARNING

Ignoring the pop-up hood message can result in a malfunction of the pop-up hood. This can result in serious injury or death if your vehicle impacts a pedestrian.

If the pop-up hood message comes on, have your vehicle checked by a dealer as soon as possible.

⌘ Pop-up Hood System Care

If the front bumper is damaged, have the vehicle checked by a dealer even if the pop-up hood system did not activate.

Protecting Child Passengers

Each year, many children are injured or killed in vehicle crashes because they are either unrestrained or not properly restrained. In fact, vehicle crashes are the number one cause of death of children aged 12 and under.

To reduce the number of child deaths and injuries, infants and children should be properly restrained when they ride in a vehicle.

Protecting Child Passengers

Front Passenger's Sun Visor

⚠️ WARNING



NEVER use a rearward facing child restraint on a seat protected by an **ACTIVE AIRBAG** in front of it, **DEATH** or **SERIOUS INJURY** to the **CHILD** can occur.

⚠️ WARNING

Children who are unrestrained or improperly restrained can be seriously injured or killed in a crash.

Any child too small for a seat belt should be properly restrained in an approved child restraint system. A larger child should be properly restrained with a seat belt, using a booster seat if necessary.

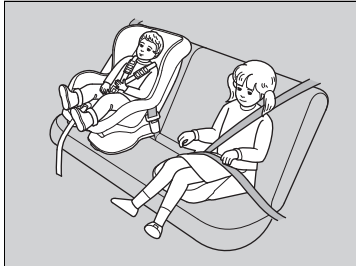

Children should sit properly restrained in a rear seat. This is because:

- An inflating front or side airbag can injure or kill a child sitting in the front seat.
- A child in the front seat is more likely to interfere with the driver's ability to safely control the vehicle.
- Statistics show that children of all sizes and ages are safer when they are properly restrained in a rear seat.

▶▶ Protecting Child Passengers

In many countries, the law requires all children aged 12 and under, and whose height are shorter than 150 cm (60 inches) be properly restrained in a rear seat.

In many countries, it is required to use an officially approved and suitable child restraint system for transporting a child on any passenger seat. Check your local legal requirement.

Child restraint systems must meet UN Regulation No. 44 or No. 129 or the regulations of the subject countries.

▶ **Selecting a Child Restraint System** P. 81

- Never hold a child on your lap because it is impossible to protect them in the event of a collision.
- Never put a seat belt over yourself and a child. During a crash, the belt would likely press deep into the child and cause serious or fatal injuries.
- Never let two children use the same seat belt. Both children could be very seriously injured in a crash.
- Any child who is too small to wear a seat belt must be properly restrained in an approved child restraint system that is properly secured to the vehicle using the seat belt or the child restraint anchorage system.
- Do not allow children to operate the doors, windows or seat adjustments.
- Do not leave children in the vehicle unattended, especially in hot weather when the inside of the vehicle can get hot enough to kill them. They could also activate vehicle controls causing it to move unexpectedly.

▶▶ Protecting Child Passengers

WARNING: Use the power window lock button to prevent children from opening the windows. Using this feature will prevent children from playing with the windows, which could expose them to hazards or distract the driver.

▶ Opening/Closing the Power Windows P. 194

WARNING: Always take the ignition key with you whenever you leave the vehicle alone or with other occupants.

To remind you of the passenger's front airbag hazard and child safety, your vehicle has the warning label on the passenger's side sun visor.

Please read and follow the instructions on the label.

▶ Safety Labels P. 103

Safety of Infants and Small Children

■ Protecting Infants

An infant must be properly restrained in a rear-facing, reclining child restraint system until the infant reaches the child restraint system manufacturer's weight or height limit for the seat, and the infant is at least one year old.

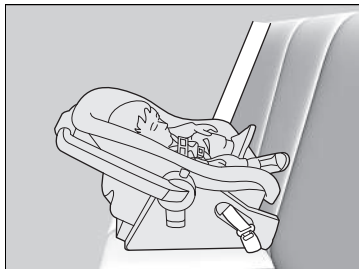

■ Positioning a rear-facing child restraint system

Child restraint system must be placed and secured in a rear seating position.

- ▶ We recommend that you install the child restraint system directly behind the front passenger's seat, move the seat as far forward as needed, and leave it unoccupied.
- ▶ Make sure that there is no contact between the child restraint system and the seat in front of it. If there is, you may wish to get a smaller rear-facing child restraint system.

▶▶ Protecting Infants

⚠ WARNING

Placing a rear-facing child restraint system in the front seat can result in serious injury or death if the passenger's front airbag inflates.

Always place a rear-facing child restraint system in the back seat, not the front.

As required by UN Regulation No. 94:

⚠ WARNING



NEVER use a rearward facing child restraint on a seat protected by an ACTIVE AIRBAG in front of it, DEATH or SERIOUS INJURY to the CHILD can occur.

When properly installed, a rear-facing child restraint system may prevent the driver or a front passenger from moving their seat all the way back, or from locking their seat-back in the desired position.

▣ Protecting Infants

Many experts recommend use of a rear-facing child restraint system for a child up to two years old if the child's height and weight are appropriate for a rear-facing child restraint system.

Rear-facing child restraint systems should never be installed in a front-facing position.

Always refer to the child restraint system manufacturer's instructions before installation.

If the passenger's front airbag inflates, it can hit the rear-facing child restraint system with great force, which can dislodge or strike the system, and seriously injure the child.

If it is absolutely unavoidable to install a rear-facing child restraint system in the front passenger seat, manually turn off the passenger front airbag system.

➤ **Passenger Front Airbag Off System** P. 62

■ Protecting Smaller Children

If a child is at least one year old and has exceeded the weight and height limitations of a rear-facing child restraint system, the child should be properly restrained in a firmly secured front-facing child restraint system until they exceed the weight and height limitations for the front-facing child restraint system.

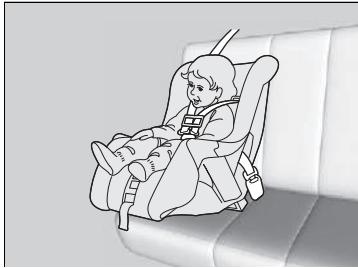

■ Front-facing child restraint system placement

We strongly recommend placing a front-facing child restraint system in a rear seating position.

Placing a front-facing child restraint system in the front seat can be hazardous. A rear seat is the safest place for a child.

▶▶ Protecting Smaller Children

⚠ WARNING

Placing a front-facing child restraint system in the front seat can result in serious injury or death if the front airbag inflates.

If you must place a front-facing child restraint system in front, move the vehicle seat as far back as possible, and properly restrain the child.

Educate yourself about the laws and regulations regarding child restraint system use where you are driving, and follow the child restraint system manufacturer's instructions.

■ Selecting a Child Restraint System

Some child restraint systems are lower anchorage compatible. Some have a rigid-type connector while others have a flexible-type connector. Both are equally easy to use. Some existing and previously owned child restraint systems can only be installed using the seat belt. Whichever type you choose, follow the child restraint system manufacturer's use and care instructions including recommended expiration dates as well as the instructions in this manual. Proper installation is key to maximising your child's safety.

The flexible type may not be available in your country.

In seating positions and vehicles not equipped with lower anchorages, install a child restraint system using the seat belt and a top tether for added security. This is because all child restraint systems must be secured with the seat belt when the lower anchorage system is not in use. In addition, the child restraint system manufacturer may advise that a seat belt be used to attach an ISOFIX restraint system once a child reaches a specified weight. Please read the child restraint system owner's manual for proper installation instructions.

■ Important consideration when selecting a child restraint system

Make sure the child restraint system meets the following three requirements:

- The child restraint system is the correct type and size for the child.
- The child restraint system is the correct type for the seating position.
- The child restraint system is compliant with safety standards. We recommend a child restraint system compliant with UN Regulation No. 44 or No. 129, or the regulations of the subject countries. Look for the approval mark on the system and the manufacturer's statement of compliance on the box.

▶▶ Selecting a Child Restraint System

Installation of a lower anchorage-compatible child restraint system is simple.

Lower anchorage-compatible child restraint systems have been developed to simplify the installation process and reduce the likelihood of injuries caused by incorrect installation.

Continued

■ Child Restraint Systems Standards

If a child restraint system (whether an i-Size/ISOFIX type or one that is fitted with a seat belt) meets the relevant UN Regulation, it will be affixed with an approval label as shown in the adjacent table. Before purchasing or using any child restraint system, make sure to check the approval label and ensure that it is compatible with your vehicle and the child, and that it complies with the relevant UN Regulation.

► Selecting a Child Restraint System

Example of UN Regulation No. 44 approval label

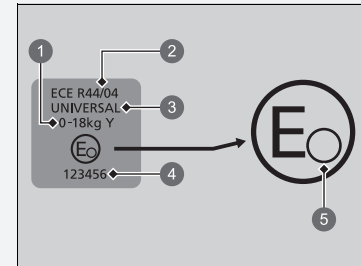

- 1 "Mass group"
- 2 Regulation number
- 3 Category
- 4 Approval number
- 5 Country code

▶▶ Selecting a Child Restraint System

Example of UN Regulation No. 129 approval label

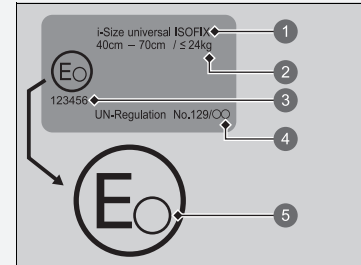

- ① Category
- ② Size and weight indication
- ③ Approval number
- ④ Regulation number
- ⑤ Country code

Locations for Child Restraint System Installation

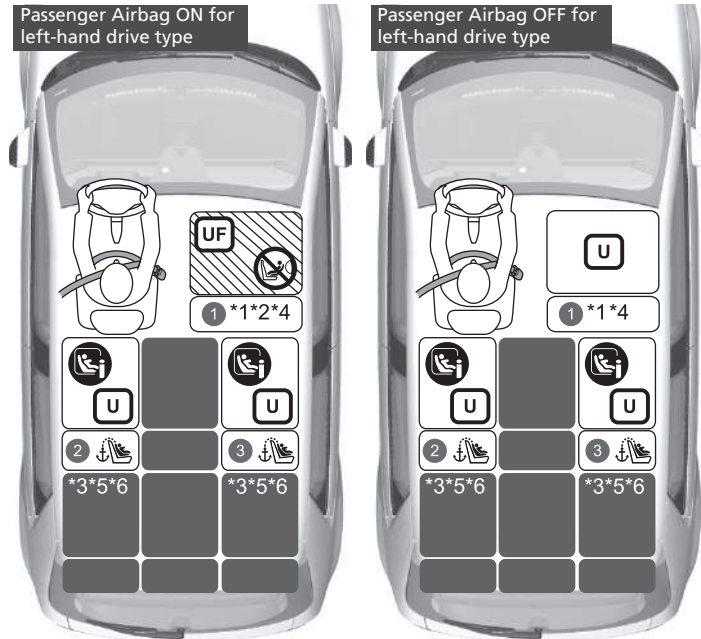

	Suitable for universal restraint systems installed with vehicle safety belts.
	Suitable for forward facing universal restraint systems installed with vehicle safety belts.
	Suitable for i-Size and ISOFIX child restraints systems.
	Suitable for forward facing restraint systems only.
	Never use a rearward facing child restraint system.
	Seat position equipped with Top Tether anchorages.

*1: Adjust the seat slide to the rearmost position.

If the child restraint system interferes with the head restraint and cannot be installed stably, raise the head restraint to the highest position. If this interference is unavoidable even after raising, remove the head restraint. Please note that the removed head restraint should be stored in the luggage compartment so that it will not fly during sudden braking or collision.

Also, if you remove the child restraint system, attach the head restraint to the original seat and make sure it is locked.

*2: Only forward facing child restraint system can be installed when the front passenger airbag is on.

*3: If the child restraint system interferes with the head restraint and cannot be installed stably, raise the head restraint to the highest position.

*4: For installing the universal belted type, adjust the seat back to the most front lock position.

- If the child restraint system on the rear seat interferes with the front seat, adjust the front seat to the position without interfere.

*5: For installing the R2 size or smaller ISOFIX child restraint system, when the child restraint system interferes the driver's seat, adjust the driver's seat to the highest position.

*6: For installing the R3 size ISOFIX child restraint system, when the child restraint interferes the driver's seat, adjust the driver's seat to the highest position and the seat back to the front lock position, and adjust the seat slide to the 11th step from most front position or forward.

When interfering passenger's seat, adjust the passenger's seat back to the front lock position and adjust the seat slide to the 10th step from most front position or forward.

- Child restraint systems with support leg can be installed in seating position where i-Size cannot be installed.

- If you cannot fix the booster child restraint system stably, adjust the seat-back angle to be parallel with the back still keeping it forward of the seat belt shoulder anchor.

Passenger Airbag ON for right-hand drive type



Passenger Airbag OFF for right-hand drive type



	Suitable for universal restraint systems installed with vehicle safety belts.
	Suitable for forward facing universal restraint systems installed with vehicle safety belts.
	Suitable for i-Size and ISOFIX child restraints systems.
	Suitable for forward facing restraint systems only.
	Never use a rearward facing child restraint system.
	Seat position equipped with Top Tether anchorages.

*1: Adjust the seat slide to the rearmost position.

If the child restraint system interferes with the head restraint and cannot be installed stably, raise the head restraint to the highest position. If this interference is unavoidable even after raising, remove the head restraint. Please note that the removed head restraint should be stored in the luggage compartment so that it will not fly during sudden braking or collision.

Also, if you remove the child restraint system, attach the head restraint to the original seat and make sure it is locked.

*2: Only forward facing child restraint system can be installed when the front passenger airbag is on.

*3: If the child restraint system interferes with the head restraint and cannot be installed stably, raise the head restraint to the highest position.

*4: For installing the universal belted type, adjust the seat back to the most front lock position.

- If the child restraint system on the rear seat interferes with the front seat, adjust the front seat to the position without interfere.

*5: For installing the R2 size or smaller ISOFIX child restraint system, when the child restraint system interferes the driver's seat, adjust the driver's seat to the highest position.

*6: For installing the R3 size ISOFIX child restraint system, when the child restraint interferes the driver's seat, adjust the driver's seat to the highest position and the seat back to the front lock position, and adjust the seat slide to the 11th step from most front position or forward.

When interfering passenger's seat, adjust the passenger's seat back to the front lock position and adjust the seat slide to the 10th step from most front position or forward.

- Child restraint systems with support leg can be installed in seating position where i-Size cannot be installed.

- If you cannot fix the booster child restraint system stably, adjust the seat-back angle to be parallel with the back still keeping it forward of the seat belt shoulder anchor.

All models

Detail information for CRS installation

Seat position number	Seating position					
	Size groups Weight Stature		①		②	③
			Front passenger *1		2nd row *3	
			Front passenger airbag ON/OFF switch position		Left	Right
ON *2	OFF					
Seating position suitable for universal belted (yes/no)	Group 0	Up to 10kg	No	Yes *4	Yes	Yes
	Group 0+	Up to 13kg				
	Group I	9-18kg				
	Group II	15-25kg				
	Group III	22-36kg				
i-Size seating position (yes/no)	≤150cm		No	No	Yes	Yes
Seating position suitable for recommended genuine CRS *7	Refer to genuine CRS list		Yes	Yes	Yes	Yes
Seating position suitable for lateral fixture (L1/L2)	—		No	No	No	No
Largest suitable rearward facing fixture (R1/R2X/R2/R3)	Group 0	Up to 10kg	No	No	R2X, R2 *5 R3 *6	R2X, R2 *5 R3 *6
	Group 0+	Up to 13kg				
	Group I	9-18kg				
Largest suitable forward facing fixture (F2X/F2/F3)	Group I	9-18kg	No	No	F3	F3
Largest suitable booster fixture (B2/B3)	≤150cm		B3	B3	B3	B3

Locations for Child Restraint System Installation

When purchasing a child restraint systems, make sure to check the ISOFIX size class or the fixture to ensure that the seat is compatible with your vehicle.

Fixture (CRF)	Description
ISO/L1	Left lateral-facing (carrycot) infant seat
ISO/L2	Right lateral-facing (carrycot) infant seat
ISO/R1	Rearward-facing infant seat
ISO/R2X	Reduced-size rearward-facing child restraint systems
ISO/R2	Reduced-size rearward-facing child restraint systems
ISO/R3	Full-size rearward-facing child restraint systems
ISO/F2X	Reduced-height forward-facing child restraint systems
ISO/F2	Reduced-height forward-facing child restraint systems
ISO/F3	Full-height, forward-facing child restraint systems
ISO/B2	Reduced width forward-facing booster seat
ISO/B3	Full width forward-facing booster seat

- *1: Adjust the seat slide to the rearmost position. If the child restraint system interferes with the head restraint and cannot be installed stably, raise the head restraint to the highest position. If this interference is unavoidable even after raising, remove the head restraint. Please note that the removed head restraint should be stored in the luggage compartment so that it will not fly during sudden braking or collision.
Also, if you remove the child restraint system, attach the head restraint to the original seat and make sure it is locked.
- *2: Only forward facing child restraint system can be installed when the front passenger airbag is on.
- *3: If the child restraint system interferes with the head restraint and cannot be installed stably, raise the head restraint to the highest position.
- *4: For installing the universal belted type, adjust the seat back to the most front lock position.
- If the child restraint system on the rear seat interferes with the front seat, adjust the front seat to the position without interfere.
- *5: For installing the R2 size or smaller ISOFIX child restraint system, when the child restraint system interferes the driver's seat, adjust the driver's seat to the highest position.
- *6: For installing the R3 size ISOFIX child restraint system, when the child restraint interferes the driver's seat, adjust the driver's seat to the highest position and the seat back to the front lock position, and adjust the seat slide to the 11th step from most front position or forward.
When interfering passenger's seat, adjust the passenger's seat back to the front lock position. And adjust the seat slide to the 10th step from most front position or forward.
- *7: The named Child Restraint Systems (CRS) reflect Honda's recommendations at the date of publication.
You should speak to an authorised dealer for up to date details relating to our recommended CRSs.
Other CRS may also be suitable - please consult CRS manufacturers for recommended vehicle lists.
- Child restraint systems with support leg can be installed in seating position where i-Size cannot be installed.
 - If you cannot fix the booster child restraint stably, adjust the seat-back angle to be parallel with the back still keeping it forward of the seat belt shoulder anchor.

■ Europe Genuine CRS List

UN R129

Range of application	Child Restraint System	Category
40cm to 83cm up to 13kg (Birth - 15 months)	Honda baby safe	Universal Belted
	Honda baby safe ISOFIX	i-Size universal ISOFIX
76cm to 105cm 9kg to 22kg (15 months - 4 years)	Honda ISOFIX	i-Size Universal ISOFIX
100cm to 150cm 15kg to 36kg (3.5 years - 12 years)	Honda KIDFIX	i-Size Booster seat

■ Installing a Lower Anchorage-Compatible Child Restraint System

A lower anchorage-compatible child restraint system can be installed in either of the two rear seats. A child restraint system is attached to the lower anchorages with either the rigid or flexible type of connectors (see illustrations).

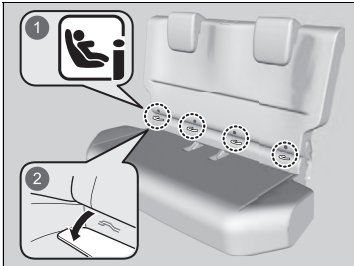

- 1 Marks
- 2 Covers

1. Locate the anchor marks affixed to the base of the seat cushion.
2. Pull out the anchorage covers under the marks to expose the lower anchorages.
 - ▶ See illustration.

ⓘ Installing a Lower Anchorage-Compatible Child Restraint System

⚠ WARNING

Never attach two child restraint systems to the same anchor. In a collision, one anchor may not be strong enough to hold two child restraint system attachments and may break, causing serious injury or death.

Some child restraint systems come with optional guide-cups, which avoid possible damage to the seat surface. Follow the manufacturer's instructions when using the guide-cups, and attach them to the lower anchorages as shown in the image.

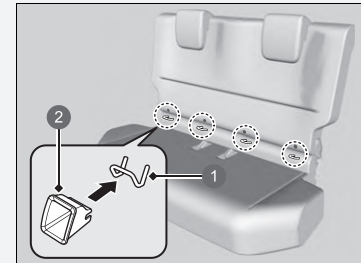

- 1 Lower Anchorages
- 2 Guide-cup

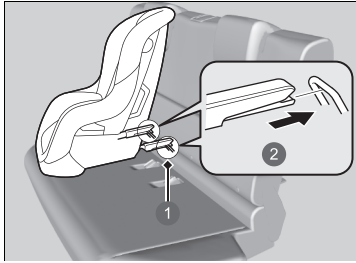

- ① Lower Anchorages
- ② Rigid Type

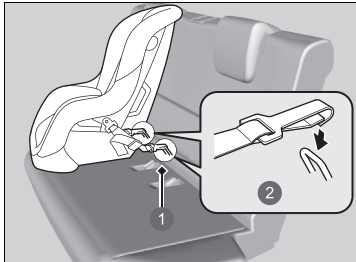

- ① Lower Anchorages
- ② Flexible Type

3. Place the child restraint system on the vehicle seat, then attach the child restraint system to the lower anchorages according to the instructions that came with the child restraint system.

- When installing the child restraint system, make sure that the lower anchorages are not obstructed by the seat belt or any other object.
- When the child restraint system interferes with the head restraint, raise its highest position.
- When the child restraint system is not placed firmly, adjust the position of the front seat.

► Installing a Lower Anchorage-Compatible Child Restraint System

For your child's safety, when using a child restraint system installed using the lower anchorage system, make sure that the child restraint system is properly secured to the vehicle. A child restraint system that is not properly secured will not adequately protect a child in a crash and may cause injury to the child or other vehicle occupants.

The flexible type may not be available in your country.

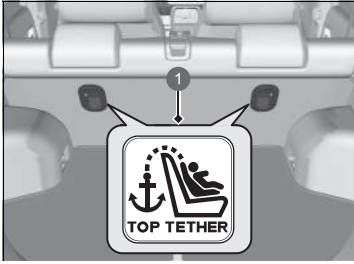

1 Top Tether Anchor Symbol

▶▶ Installing a Lower Anchorage-Compatible Child Restraint System

WARNING: Never use a hook that does not come with a Top Tether anchor symbol when securing an installed child restraint system.

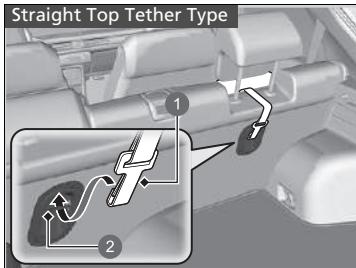

- 1 Tether Strap Hook
- 2 Anchorage

Child restraint system with tether strap

4. If the head restraint is not its highest position, raise its highest position.
 - ▶ Retract the luggage area cover.
 - **Luggage Area Cover** P. 241

Straight Top Tether Type

5. Route the tether strap between the head restraint legs, and secure the tether strap hook to the anchorage.
 - ▶ Make sure the strap is not twisted.

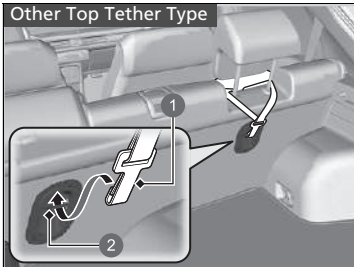

- 1 Tether Strap Hook
- 2 Anchorage

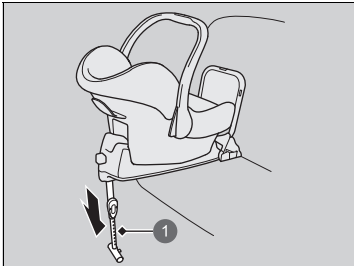

- 1 Support Leg

Other Top Tether Type

5. Route the tether strap through the outsides of the head restraint legs, and secure the tether strap hook to the anchorage.
 - ▶ Make sure the strap is not twisted.

Child restraint system with tether strap

6. Tighten the tether strap as instructed by the child restraint system manufacturer.
7. Make sure the child restraint system is firmly secured by rocking it forward and back, and side to side; little movement should be felt.

Child restraint system with support leg

6. Extend the support leg until it touches the floor as instructed by the child restraint system manufacturer.
 - ▶ Confirm that the section of the floor on which the support leg rests is level. If the section is not level, the support leg will not provide adequate support.
 - ▶ Make sure that there is no contact between the child restraint system and the seat in front of it.

■ Installing a Child Restraint System with a Lap/Shoulder Seat Belt

A child restraint system can be installed with a lap/shoulder belt in any rear seat or, if absolutely necessary, the front passenger seat.



1. Place the child restraint system on the vehicle seat.
 - ▶ When the child restraint system is not placed firmly, adjust the position of the front seat.
 - ▶ When the child restraint system is not placed firmly, raise the head restraint to its highest position.
2. Route the seat belt through the child restraint system according to the child restraint system manufacturer's instructions, and insert the latch plate into the buckle.
 - ▶ Insert the latch plate fully until it clicks.

ⓘ Installing a Child Restraint System with a Lap/Shoulder Seat Belt

A child restraint system that is not properly secured will not adequately protect a child in a crash and may cause injury to the child or other vehicle occupants.

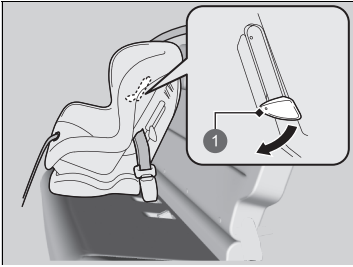

1 Tab

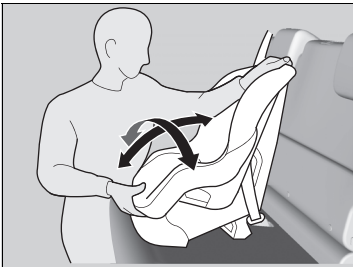

3. Push down the tab. Route the shoulder part of the belt into the slit at the side of the restraint.
4. Grab the shoulder part of the belt near the buckle, and pull up to remove any slack from the lap part of the belt.
 - ▶ When doing this, place your weight on the child restraint system and push it into the vehicle seat.
5. Position the belt properly and push up the tab. Make sure the belt is not twisted.
 - ▶ When pushing up the tab, pull up the upper shoulder part of the belt to remove any slack from the belt.
6. Make sure the child restraint system is firmly secured by rocking it forward and back, and side to side; little movement should be felt.
7. Make sure any unused seat belt that a child can reach is buckled.

■ Adding Security with a Tether

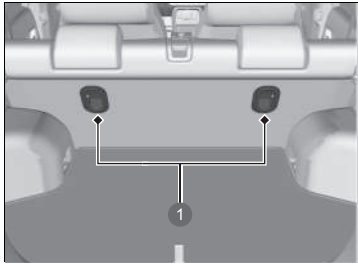

① Tether Anchorage Points

A tether anchorage point is provided behind each rear seating position. If you have a child restraint system that comes with a tether but can be installed with a seat belt, the tether may be used for additional security.

1. Locate the appropriate tether anchorage point.
 - ▶ Retract the luggage area cover.
 ▶ **Luggage Area Cover** P. 241

▣ Adding Security with a Tether

WARNING: Child restraint anchorages are designed to withstand only those loads imposed by correctly fitted child restraints. Under no circumstances are they to be used for adult seat belts, harnesses or for attaching other items or equipment to the vehicle.

Always use a tether for front-facing child restraint system when using the seat belt or lower anchorages.

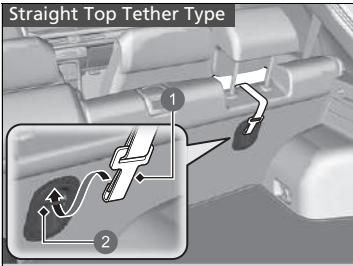

- 1 Tether Strap Hook
- 2 Anchorage

Straight Top Tether Type

2. Raise the head restraint to its highest position, then route the tether strap between the head restraint legs, and secure the tether strap hook to the anchorage.
 - ▶ Make sure the strap is not twisted.

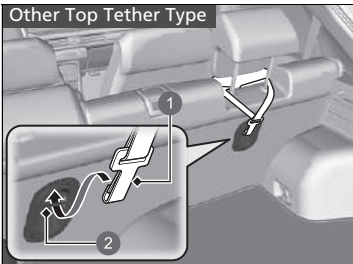

- 1 Tether Strap Hook
- 2 Anchorage

Other Top Tether Type

2. Raise the head restraint to its highest position, route the tether strap through the outsides of the head restraint legs, and secure the tether strap hook to the anchorage.
 - ▶ Make sure the strap is not twisted.

All Models

3. Secure the tether strap hook to the anchorage.
4. Tighten the tether strap as instructed by the child restraint system manufacturer.

Safety of Larger Children

■ Protecting Larger Children

The following pages give instructions on how to check proper seat belt fit, what kind of booster seat to use if one is needed, and important precautions for a child who must sit in front.

■ Checking Seat Belt Fit

When a child is too big for a child restraint system, secure the child in a rear seat using the lap/shoulder seat belt. Have the child sit upright and all the way back, then answer the following questions.



■ Checklist

- Do the child's knees bend comfortably over the edge of the seat?
- Does the shoulder belt cross between the child's neck and arm?
- Is the lap part of the seat belt as low as possible, touching the child's thighs?
- Will the child be able to stay seated like this for the whole trip?

If you answer yes to all these questions, the child is ready to wear the lap/shoulder seat belt correctly. If you answer no to any question, the child needs to ride on a booster seat until the seat belt fits properly without a booster seat.

▶ Safety of Larger Children

⚠ WARNING

Allowing a child aged 12 or under to sit in front can result in injury or death if the passenger's front airbag inflates.

If a larger child must ride in front, move the vehicle seat as far to the rear as possible, have the child sit up properly and wear the seat belt properly, using a booster seat if needed.

Booster Seats

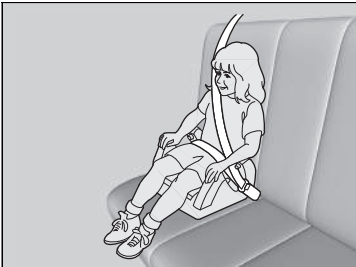

If a lap/shoulder seat belt cannot be used properly, position the child in a booster seat in the rear seat. For the child's safety, check that the child meets the booster seat manufacturer's recommendations.



A backrest is available for a specific booster seat. Install the backrest to the booster seat and adjust it to the vehicle seat according to the booster seat manufacturer's instructions. Make sure the seat belt is properly routed through the guide at the shoulder of the backrest and the belt does not touch and cross the child's neck.

1 Guide

Booster Seats

When installing a booster seat, make sure to read the instructions that came with it, and install the seat accordingly.

There are high- and low-type booster seats. Choose a booster seat that allows the child to wear the seat belt correctly.

We recommend a booster seat with a backrest as it is easier to adjust the shoulder belt.

■ Protecting Larger Children - Final Checks

Your vehicle has a rear seat where children can be properly restrained. If you ever have to carry a group of children, and a child must ride in front:

- Make sure you read and fully understand the instructions and safety information in this manual.
- Move the front passenger seat as far back as possible.
- Have the child sit upright and well back in the seat.
- Check that the seat belt is properly positioned so that the child is secure in the seat.

■ Monitoring child passengers

We strongly recommend that you keep an eye on child passengers. Even older, more mature children sometimes need to be reminded to fasten their seat belts and sit up properly.

Label Locations

These labels are in the locations shown. They warn you of potential hazards that can cause serious injury or death. Read these labels carefully.

If a label comes off or becomes hard to read, contact a dealer for a replacement.

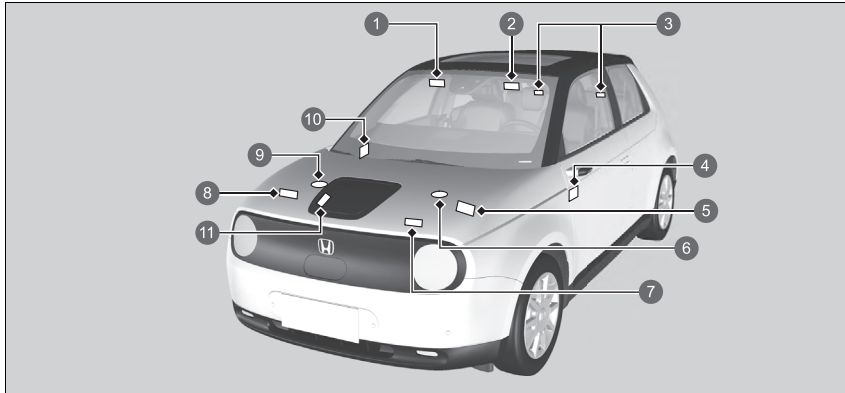

- ① Protecting Child Passenger (Left-hand drive type) ➤ P. 75
- ② Protecting Child Passenger (Right-hand drive type) ➤ P. 75
- ③ Rear Head Restraint ➤ P. 232
- ④ Passenger Front Airbag Off System (Right-hand drive type) ➤ P. 64
- ⑤ 12-Volt Battery ➤ P. 613
- ⑥ PCU Coolant Reserve Tank ➤ P. 589
- ⑦ Air Conditioner ➤ P. 616
- ⑧ Pop-up Hood ➤ P. 73
- ⑨ IPU Coolant Reserve Tank ➤ P. 589
- ⑩ Passenger Front Airbag Off System (Left-hand drive type) ➤ P. 64
- ⑪ Charging Information Label* ➤ P. 560, 565





















* Not available on all models

Instrument Panel























This chapter describes the buttons, indicators, and gauges that are used while driving.



Indicators	106
Driver Information Interface Warning and Information Messages.....	130
Gauges and Displays	
Gauges.....	154
Driver Information Interface	156





 *1	Parking Brake and Brake System Indicator (Red)	→P. 108	 *1	Transmission System Indicator	→P. 113	 *1	Anti-lock Brake System (ABS) Indicator	→P. 116
 *1	Parking Brake and Brake System Indicator (Amber)	→P. 110	 *1	Deceleration Paddle Selector Indicator	→P. 114	 *1	Supplemental Restraint System Indicator	→P. 116
 *1	Automatic Brake Hold System Indicator	→P. 109	 *1	Power System Indicator	→P. 111	 *1	Passenger Front Airbag On/Off Indicators	→P. 116
 *1	Automatic Brake Hold Indicator	→P. 109	 *1	Ready Indicator	→P. 112	 *1	Electric Power Steering (EPS) System Indicator	→P. 117
 *1	12-Volt Battery Charging System Indicator	→P. 112	 *1	SPORT Mode Indicator	→P. 114	 *1	Low Tyre Pressure/Deflation Warning System Indicator	→P. 118
 *1	Shift Position Indicator	→P. 113	 *1	NORMAL Mode Indicator	→P. 114	 *1	System Message Indicator	→P. 119
			 *1	Seat Belt Reminder Indicator	→P. 115	 *1	Turn Signal and Hazard Warning Indicators	→P. 119
			 *1	Low Charge Indicator (Amber)	→P. 115			



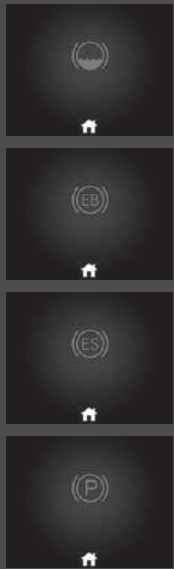

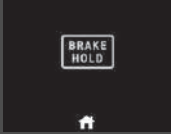

*1: When you set the power mode to ON, these indicators come on to indicate that system checks are being performed. They go off a few seconds later or after the power system has been turned on. If an indicator does not come on or turn off, there may be a malfunction in the corresponding system. To resolve the issue, follow the instructions in the owner's manual.





	Lights On Indicator	→P. 120		Vehicle Stability Assist (VSA) OFF Indicator	→P. 117		*1 Lane Keeping Assist System (LKAS) Indicator (Amber)	→P. 123
	High Beam Indicator	→P. 120		Road Departure Mitigation Ready to Assist Indicator	→P. 124		Lane Keeping Assist System (LKAS) Indicator (Green)	→P. 123
	Auto High-Beam Indicator	→P. 120		Adjustable Speed Limiter Indicator (White/Green)	→P. 122		*1 Safety Support Indicator (Amber)	→P. 125
	Front Fog Light Indicator	→P. 120		Intelligent Speed Limiter Indicator (White/Green)	→P. 122		Safety Support Indicator (Green/Grey)	→P. 128
	Rear Fog Light Indicator	→P. 120		Adaptive Cruise Control (ACC) with Low Speed Follow Distance Indicator	→P. 123		*1 Parking Sensor Indicator (Amber)	→P. 124
	Security System Alarm Indicator	→P. 121		*1 Adaptive Cruise Control (ACC) with Low Speed Follow Indicator (Amber)	→P. 122		Parking Sensor Indicator (Green)	→P. 124
	Immobilizer System Indicator	→P. 121		Adaptive Cruise Control (ACC) with Low Speed Follow Indicator (White/Green)	→P. 123		Single Pedal Indicator	→P. 124
	*1 Vehicle Stability Assist (VSA) System Indicator	→P. 117					*1 Side Camera Mirror System Indicator	→P. 129





*1: When you set the power mode to ON, these indicators come on to indicate that system checks are being performed. They go off a few seconds later or after the power system has been turned on. If an indicator does not come on or turn off, there may be a malfunction in the corresponding system. To resolve the issue, follow the instructions in the owner's manual.









Indicator	Name	On/Blinking	Explanation	Message
 <p>(Red)</p>	<p>Parking Brake and Brake System Indicator (Red)</p>	<ul style="list-style-type: none"> • Comes on when the parking brake is applied and goes off when it is released. • Comes on when the brake fluid level is low. • Comes on if there is a problem with the brake system. • The beeper sounds and the indicator comes on if you drive with the parking brake applied. 	<ul style="list-style-type: none"> • Comes on while driving - Make sure the parking brake is released. Check the brake fluid level. <ul style="list-style-type: none"> ➤ What to do when the indicator comes on while driving P. 652 • Comes on along with the parking brake and brake system indicator (amber) - Immediately stop in a safe place. Contact a dealer for repair. The brake pedal becomes harder to operate. Depress the pedal further than you normally do. <ul style="list-style-type: none"> ➤ If the Brake System Indicator (Red) Comes On or Blinks at the Same Time When the Brake System Indicator (Amber) Comes On P. 654 • Comes on along with the ABS indicator - Have your vehicle checked by a dealer. <ul style="list-style-type: none"> ➤ If the Brake System Indicator (Red) Comes On or Blinks P. 652 	

Indicator	Name	On/Blinking	Explanation	Message
 (Red)	Parking Brake and Brake System Indicator (Red)	<ul style="list-style-type: none"> Comes on for about 30 seconds when you apply the electric parking brake while the power mode is in ACCESSORY or VEHICLE OFF, then goes off. Stays on for about 30 seconds when you set the power mode to VEHICLE OFF while the electric parking brake is applied, then goes off. 	<ul style="list-style-type: none"> Blinks and the parking brake and brake system indicator (amber) comes on at the same time - There is a problem with the electric parking brake system. The parking brake may not be set. Avoid using the parking brake and have your vehicle checked by a dealer immediately. <ul style="list-style-type: none"> ➤ If the Brake System Indicator (Red) Comes On or Blinks at the Same Time When the Brake System Indicator (Amber) Comes On P. 654 	—
	Automatic Brake Hold System Indicator	<ul style="list-style-type: none"> Comes on when the automatic brake hold system is on. 	<ul style="list-style-type: none"> ➤ Automatic Brake Hold P. 501 	
	Automatic Brake Hold Indicator	<ul style="list-style-type: none"> Comes on when the automatic brake hold is activated. 	<ul style="list-style-type: none"> ➤ Automatic Brake Hold P. 501 	—



Indicator	Name	On/Blinking	Explanation	Message
 (Amber)	Parking Brake and Brake System Indicator (Amber)	<ul style="list-style-type: none"> Comes on if there is a problem with a system related to braking other than the conventional brake system. Comes on if there is a problem with the cooperative control with regenerative braking, the electric servo brake system, the single pedal control and the Honda Parking Pilot*. 	<ul style="list-style-type: none"> Comes on while driving - Avoid high speeds and sudden braking. Take the vehicle to a dealer immediately. 	     

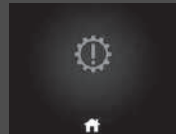

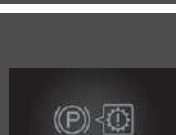

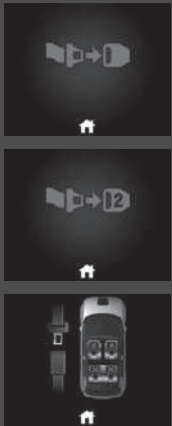

Indicator	Name	On/Blinking	Explanation	Message
 (Amber)	Parking Brake and Brake System Indicator (Amber)	<ul style="list-style-type: none"> Comes on if there is a problem with the electric parking brake system and/or the automatic brake hold system. 	<ul style="list-style-type: none"> Stays on constantly - Avoid using the parking brake and have your vehicle checked by a dealer immediately. 	
	Power System Indicator	<ul style="list-style-type: none"> Comes on if there is a problem with the electric vehicle system or plug-in charging system. 	<ul style="list-style-type: none"> Have your vehicle checked by a dealer immediately. <ul style="list-style-type: none"> ▣ If the Power System Indicator Comes On P. 657 Comes on when you set the power mode to ON after having charged your vehicle - Have your vehicle checked by a dealer immediately. 	





Indicator	Name	On/Blinking	Explanation	Message
	Ready Indicator	<ul style="list-style-type: none"> Comes on when the vehicle is ready to drive. 	<ul style="list-style-type: none"> ➤ Turning on the Power P. 379 	
	12-Volt Battery Charging System Indicator	<ul style="list-style-type: none"> Comes on when the 12-volt battery is not charging. 	<ul style="list-style-type: none"> Stop in a safe place and have your vehicle checked by a dealer immediately. <ul style="list-style-type: none"> ➤ If the 12-Volt Battery Charging System Indicator Comes On P. 651 	



Indicator	Name	On/Blinking	Explanation	Message
	Shift Position Indicator	<ul style="list-style-type: none"> Indicates the current shift position. 	<ul style="list-style-type: none">  Shifting P. 384 	
	Transmission System Indicator	<ul style="list-style-type: none"> The current shift position or all the shift positions blink if there is a problem with the transmission system. The indicated current shift position or all the shift positions blink if you cannot select P due to a transmission system failure. 	<ul style="list-style-type: none"> Avoid sudden start and acceleration, and stop in a safe place immediately. <ul style="list-style-type: none">  Emergency Towing P. 667 Have your vehicle checked by a dealer. The power system can be activated as a temporary measure. <ul style="list-style-type: none">  If the Transmission System Indicator Blinks along with the Warning Message P. 656 Set the parking brake when parking. Have your vehicle checked by a dealer immediately. 	  

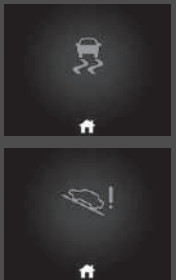

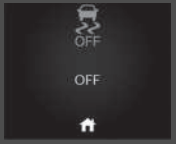

Indicator	Name	On/Blinking	Explanation	Message
 	Deceleration Paddle Selector Indicator	<ul style="list-style-type: none"> • Comes on when the paddle selector is pulled. • Blinks when deceleration does not occur while pulling the paddle selector. 	<ul style="list-style-type: none"> ➤ Deceleration Paddle Selector P. 393 ➤ Single Pedal Control P. 396 	—
SPORT	SPORT Mode Indicator	<ul style="list-style-type: none"> • Comes on when you set the driving mode to SPORT. 	<ul style="list-style-type: none"> ➤ SPORT Mode P. 392 	—
NORMAL	NORMAL Mode Indicator	<ul style="list-style-type: none"> • Comes on when you set the driving mode to NORMAL. 	<ul style="list-style-type: none"> ➤ NORMAL Mode P. 392 	—









Indicator	Name	On/Blinking	Explanation	Message
	Seat Belt Reminder Indicator	<ul style="list-style-type: none"> • Comes on if you are not wearing a seat belt when you set the power mode to ON. • If the front passenger is not wearing a seat belt, the indicator comes on a few seconds later. • Blinks while driving if either you or the passenger has not fastened a seat belt. The beeper sounds and the indicator blinks at regular intervals. • Comes on for a while when the rear seat belt is unfastened while the power mode to on, and a red icon is displayed on the driver information interface. 	<ul style="list-style-type: none"> • The beeper stops and the indicator goes off when you and the passenger fasten their seat belts. • Stays on after you or the passenger has fastened the seat belt - A detection error may have occurred in the sensor. Have your vehicle checked by a dealer. • When the seat belt has fastened, the indicator will turn off and a green icon is displayed on the driver information interface. <ul style="list-style-type: none"> ▶ Seat Belt Reminder P. 48 	
	Low Charge Indicator (Amber)	<ul style="list-style-type: none"> • Comes on when the High Voltage battery is running low (approximately 15% left). 	<ul style="list-style-type: none"> • Comes on - There is a decrease in acceleration performance. Recharge the High Voltage battery as soon as possible. 	





Indicator	Name	On/Blinking	Explanation	Message
	Anti-lock Brake System (ABS) Indicator	<ul style="list-style-type: none"> Comes on if there is a problem with the ABS. 	<ul style="list-style-type: none"> Stays on constantly - Have your vehicle checked by a dealer. With this indicator on, your vehicle still has normal braking ability but no anti-lock function. <ul style="list-style-type: none"> ➤ Anti-lock Brake System (ABS) P. 504 	
	Supplemental Restraint System Indicator	<ul style="list-style-type: none"> Comes on if a problem with any of the following is detected: <ul style="list-style-type: none"> - Supplemental Restraint System - Side airbag system - Side curtain airbag system - Seat belt tensioner 	<ul style="list-style-type: none"> Stays on constantly - Have your vehicle checked by a dealer. 	
	Passenger Front Airbag On/Off Indicators	<ul style="list-style-type: none"> When the passenger front airbag is active: The on indicator comes back on and remains on for about 65 seconds. When the passenger front airbag is inactive: The off indicator comes back on and stays on. This is a reminder that the passenger front airbag is deactivated. 	<ul style="list-style-type: none"> ➤ Passenger Front Airbag Off System P. 62 	





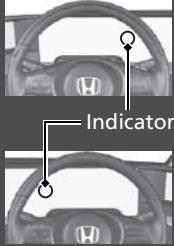

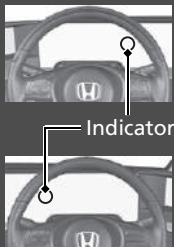

Indicator	Name	On/Blinking	Explanation	Message
	Vehicle Stability Assist (VSA) System Indicator	<ul style="list-style-type: none"> • Blinks when VSA is active. • Comes on if there is a problem with the VSA system or hill start assist system. 	<ul style="list-style-type: none"> • Stays on constantly - Have your vehicle checked by a dealer. <ul style="list-style-type: none"> ▣ Vehicle Stability Assist (VSA) System P. 416 ▣ Hill Start Assist System P. 381 	
	Vehicle Stability Assist (VSA) OFF Indicator	<ul style="list-style-type: none"> • Comes on when you partially disable VSA. 	<ul style="list-style-type: none"> ▣ VSA On and Off P. 417 	
	Electric Power Steering (EPS) System Indicator	<ul style="list-style-type: none"> • Comes on if there is a problem with the EPS System. 	<ul style="list-style-type: none"> • Comes on while driving - Immediately stop in a safe place. • Stays on constantly - Have your vehicle checked by a dealer. <ul style="list-style-type: none"> ▣ If the Electric Power Steering (EPS) System Indicator Comes On P. 653 	









Indicator	Name	On/Blinking	Explanation	Message
	<p>Low Tyre Pressure/Deflation Warning System Indicator</p>	<ul style="list-style-type: none"> • May come on briefly if the power mode is set to ON and the vehicle is not moved within 45 seconds, to indicate the initialisation process is not yet complete. • Comes on and stays on when: <ul style="list-style-type: none"> - One or more tyres' pressures are determined to be significantly low. - The system has not been initialised. • Blinks for about one minute, and then stays on if there is a problem with the deflation warning system. 	<ul style="list-style-type: none"> • Comes on while driving - Stop in a safe place, check tyre pressures, and inflate the tyre(s) if necessary. • Stays on after the tyres are inflated to the recommended pressures - The system needs to be initialised. <ul style="list-style-type: none"> ▣ Deflation Warning System P. 418 • Blinks and remains on - Have your vehicle checked by a dealer. 	









Indicator	Name	On/Blinking	Explanation	Message
	System Message Indicator	<ul style="list-style-type: none"> • Comes on along with a beep when a problem is detected. A system message on the driver information interface appears at the same time. 	<ul style="list-style-type: none"> • While the indicator is on, press the , and select  (information) to see the message again. <ul style="list-style-type: none"> ➤ Switching the Display P. 156 • Refer to the Indicators information in this chapter when a system message appears on the driver information interface. Respond to the message accordingly. • The driver information interface does not return to the normal screen unless the warning is cancelled, or the  (home) button is pressed. 	—
	Turn Signal and Hazard Warning Indicators	<ul style="list-style-type: none"> • Blinks when you operate the turn signal lever. • Blinks along with all turn signals when you press the hazard warning button. • Blinks along with all turn signals when you depress the brake pedal while the high speed driving. 	<ul style="list-style-type: none"> • Does not blink or blinks rapidly - Have your vehicle checked by a dealer. ➤ Emergency Stop Signal P. 506 	—



Indicator	Name	On/Blinking	Explanation	Message
	Lights On Indicator	<ul style="list-style-type: none"> Comes on when the position, tail, and other external lights are on. 	 Lights P. 201	—
	High Beam Indicator	<ul style="list-style-type: none"> Comes on when the high beam headlights are on. 	—	—
	Auto High-Beam Indicator	<ul style="list-style-type: none"> Comes on when all the operating conditions of the auto high-beam are met. 	 Auto High-Beam P. 206	—
	Front Fog Light Indicator	<ul style="list-style-type: none"> Comes on when the front fog lights are on. 	 Fog Lights P. 204	—
	Rear Fog Light Indicator	<ul style="list-style-type: none"> Comes on when the rear fog light is on. 	 Fog Lights P. 204	—





Indicator	Name	On/Blinking	Explanation	Message
	<p>Immobilizer System Indicator</p>	<ul style="list-style-type: none"> Blinks if the immobilizer system cannot recognise the key information. 	<ul style="list-style-type: none"> Blinks - You cannot start the power system. Set the power mode to VEHICLE OFF, then select the ON mode again. <p>Right-hand drive type Depress and hold the brake pedal before setting the power mode to ON.</p> <p>All models</p> Repeatedly blinks - The system may be malfunctioning. Have your vehicle checked by a dealer. Do not attempt to alter this system or add other devices to it. Electrical problems can occur. 	
	<p>Security System Alarm Indicator</p>	<ul style="list-style-type: none"> Blinks when the security system alarm has been set. 	<p> Security System Alarm P. 189</p>	<p>—</p>





Indicator	Name	On/Blinking	Explanation	Message
	Adjustable Speed Limiter Indicator (White/Green)	<ul style="list-style-type: none"> Lights up in white when you press the  button. If a different indicator comes on, subsequently press the LIM button. Lights up in green when the adjustable speed limiter is set. 	<ul style="list-style-type: none">  Adjustable Speed Limiter P. 403 	—
	Intelligent Speed Limiter Indicator (White/Green)	<ul style="list-style-type: none"> Lights up in white when you press the  button. If a different indicator comes on, subsequently press the LIM button. Lights up in green when you press the RES/+ button or SET/- button. 	<ul style="list-style-type: none">  Intelligent Speed Limiter P. 408 	—
	Adaptive Cruise Control (ACC) with Low Speed Follow Indicator (Amber)	<ul style="list-style-type: none"> Comes on if there is a problem with ACC with Low Speed Follow. 	<ul style="list-style-type: none"> Comes on while driving - Have your vehicle checked by a dealer. 	

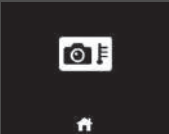

Indicator	Name	On/Blinking	Explanation	Message
	Adaptive Cruise Control (ACC) with Low Speed Follow Indicator (White/Green)	<ul style="list-style-type: none"> Lights up in white when you press the  button. If a different indicator comes on, subsequently press the LIM button. Lights up in green when you press the RES/+ button or SET/- button. 	<p>➤ Adaptive Cruise Control (ACC) with Low Speed Follow P. 445</p>	
	Adaptive Cruise Control (ACC) with Low Speed Follow Distance Indicator	<ul style="list-style-type: none"> Comes on when Adaptive Cruise Control (ACC) with Low Speed Follow indicator comes on. 	<ul style="list-style-type: none"> Each time you press the interval button, the following interval (the interval behind a vehicle detected ahead of you) setting cycles through extra long, long, middle, and short following intervals. <p>➤ To Set or Change Following-interval P. 457</p>	
	Lane Keeping Assist System (LKAS) Indicator (Amber)	<ul style="list-style-type: none"> Comes on if there is a problem with the LKAS. 	<ul style="list-style-type: none"> Stays on constantly - Have your vehicle checked by a dealer. 	
	Lane Keeping Assist System (LKAS) Indicator (Green)	<ul style="list-style-type: none"> Comes on when you press the LKAS button. 	<p>➤ Lane Keeping Assist System (LKAS) P. 465</p>	



Indicator	Name	On/Blinking	Explanation	Message
	Road Departure Mitigation Ready to Assist Indicator	<ul style="list-style-type: none"> Comes on when all activation conditions for the Road Departure Mitigation system are satisfied and lane markers are detected. 	<p>➤ Road Departure Mitigation System P. 476</p>	
	Parking Sensor Indicator (Amber)	<ul style="list-style-type: none"> Comes on if there is a problem with the parking sensor. 	<ul style="list-style-type: none"> Check if the area around the sensor(s) is covered with mud, ice, snow, etc. If the indicator(s) stays on even after you clean the area, have the system checked by a dealer. 	
	Parking Sensor Indicator (Green)	<ul style="list-style-type: none"> Comes on when parking sensor is on. 	<p>➤ Parking Sensor System P. 509</p>	
	Single Pedal Indicator	<ul style="list-style-type: none"> Comes on when the single pedal control system is turned on. 	<p>➤ Single Pedal Control P. 396</p>	

Indicator	Name	On/Blinking	Explanation	Message
	<p>Safety Support Indicator (Amber)</p>	<ul style="list-style-type: none"> Comes on if there is a problem with the Road Departure Mitigation system, blind spot information system, Low Speed Braking Control or CMBS. 	<ul style="list-style-type: none"> Stays on constantly - Have your vehicle checked by a dealer. 	



Indicator	Name	On/Blinking	Explanation	Message
	Safety Support Indicator (Amber)	<ul style="list-style-type: none"> Comes on when the Road Departure Mitigation system, blind spot information system, Low Speed Braking Control and/or CMBS shuts itself off. 	<ul style="list-style-type: none"> Indicator may come on temporarily when passing through an enclosed space, such as a tunnel. The area around the radar sensor is blocked by dirt, mud, etc. Stop your vehicle in a safe place and wipe the debris off with a soft cloth. Indicator may take some time to go off after the radar sensor is cleaned. Have your vehicle checked by a dealer if the indicator does not go off even after you have cleaned the radar sensor. <p> Radar Sensor P. 494</p>	
			<ul style="list-style-type: none"> Stays on - The temperature inside the camera is too high. Use the climate control system to cool down the camera. The system activates when the temperature inside the camera cools down. <p> Front Sensor Camera P. 492</p>	

Indicator	Name	On/Blinking	Explanation	Message
	Safety Support Indicator (Amber)	<ul style="list-style-type: none"> Comes on when the Road Departure Mitigation system, blind spot information system, Low Speed Braking Control and/or CMBS shuts itself off. 	<ul style="list-style-type: none"> Stays on - The area around the camera is blocked by dirt, mud, etc. Stop your vehicle in a safe place and wipe the debris off with a soft cloth. Have your vehicle checked by a dealer if the indicator and message are still displayed even after you have cleaned the area around the camera. <ul style="list-style-type: none"> ➤ Front Sensor Camera P. 492 	
		<ul style="list-style-type: none"> Comes on when mud, snow, or ice accumulates in the vicinity of sonar. 	<ul style="list-style-type: none"> Remove the obstacle in the vicinity of sonar sensor. <ul style="list-style-type: none"> ➤ Low Speed Braking Control P. 439 	
		<ul style="list-style-type: none"> Comes on when mud, snow, or ice has accumulated in the vicinity of the blind spot information system sensor. 	<ul style="list-style-type: none"> Comes on while driving - Something may be interfering with the blind spot information system sensor. Check the vicinity of the blind spot information system sensor and remove any obstacles. <ul style="list-style-type: none"> ➤ Blind spot information System P. 421 	





Indicator	Name	On/Blinking	Explanation	Message
	Safety Support Indicator (Green/Grey)	<ul style="list-style-type: none"> • Lights up in green when the Road Departure Mitigation system, blind spot information system, Low Speed Braking Control and CMBS are on. • Lights up in green and grey when the Road Departure Mitigation system, blind spot information system, Low Speed Braking Control or CMBS is off. • Lights up in grey when the Road Departure Mitigation system, blind spot information system, Low Speed Braking Control and CMBS are off. 	<ul style="list-style-type: none"> ➤ Road Departure Mitigation On and Off P. 479 ➤ Blind spot information On and Off P. 424 ➤ System On and Off P. 442 ➤ CMBS On and Off P. 432 	



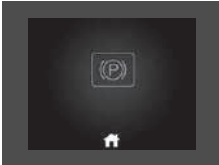
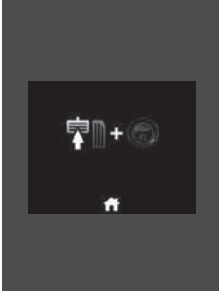

Indicator	Name	On/Blinking	Explanation	Message
	Side Camera Mirror System Indicator	<ul style="list-style-type: none"> • Comes on when there is a problem with the side camera mirror system. 	<ul style="list-style-type: none"> • Have your vehicle checked by a dealer. 	
		<ul style="list-style-type: none"> • Comes on when the vehicle interior is too hot and the image is dark or no image is displayed. • Comes on when the image is deteriorated when the temperature inside the vehicle is too low. 	<p>➤ Side Camera Mirror System P. 220</p>	

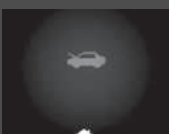

Driver Information Interface Warning and Information Messages



The following messages appear only on the driver information interface. Press the  (home) button, select  (information), then press the left selector wheel to see the message again with the system message indicator on.



Message	Condition	Explanation
	<ul style="list-style-type: none"> Appears when the vehicle is no longer able to run due to a malfunction. 	<ul style="list-style-type: none"> Immediately stop in a safe place.
	<ul style="list-style-type: none"> Appears when there is a risk that the vehicle will move unexpectedly after you have stopped due to a malfunction with the vehicle. 	<ul style="list-style-type: none"> While the vehicle is stopped, apply the parking brake. <ul style="list-style-type: none"> ➤ Parking Brake P. 497 Have your vehicle checked by a dealer.
	<ul style="list-style-type: none"> Appears after you set the power mode to ACCESSORY or ON. 	<ul style="list-style-type: none"> ➤ Turning on the Power P. 379
	<p>Right-hand drive type</p> <ul style="list-style-type: none"> Appears after you unlock and open the driver's door. 	<ul style="list-style-type: none"> ➤ Auto Power ON/OFF P. 198
	<ul style="list-style-type: none"> Appears when you need to press the POWER button because Auto Power ON is inhibited. 	<ul style="list-style-type: none"> ➤ Turning on the Power P. 379
<ul style="list-style-type: none"> Appears when you set the power mode to ON again and the vehicle is able to run. 	<ul style="list-style-type: none"> ➤ Turning on the Power P. 379 	

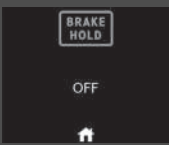

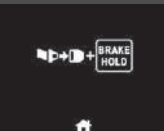

Message	Condition	Explanation
	<ul style="list-style-type: none"> • Appears if any door or the tailgate is not completely closed. • Appears if any door or the tailgate is opened while driving. The beeper sounds. 	<ul style="list-style-type: none"> • Disappears when all doors and the tailgate are closed.
	<ul style="list-style-type: none"> • Appears if there is a problem with the acoustic vehicle alerting system. 	<ul style="list-style-type: none"> • Have your vehicle checked by a dealer immediately.
	<ul style="list-style-type: none"> • Appears when the bonnet is opened. 	<ul style="list-style-type: none"> • Close the bonnet.
	<ul style="list-style-type: none"> • Appears when there is a problem with the 12-volt battery charging system. 	<ul style="list-style-type: none"> • Have your vehicle checked by a dealer.

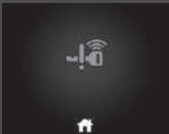

Message	Condition	Explanation
	<ul style="list-style-type: none"> Appears once if the outside temperature is below 3°C while the power mode is in ON. 	<ul style="list-style-type: none"> There is a possibility that the road surface is icy and slippery.
	<ul style="list-style-type: none"> Appears if there is a problem with the automatic lighting control system. 	<ul style="list-style-type: none"> Appears while driving - Manually turn the lights on, and have your vehicle checked by a dealer.
	<ul style="list-style-type: none"> Appears if there is a problem with the headlights. 	<ul style="list-style-type: none"> Appears while driving - The headlights may not be on. When conditions allow you to drive safely, have your vehicle checked by a dealer as soon as possible.
 <p>(White)</p>	<ul style="list-style-type: none"> Appears when you set the power mode to ON, without fastening the driver's seat belt. Appears when the driver's seat belt is unfastened while your vehicle is automatically stopped by ACC. Appears when pressing the RES/+ or SET/- button while the driver's seat belt is unfastened. 	<ul style="list-style-type: none"> Fasten the seat belt properly before you start to drive. ACC has been automatically cancelled. <ul style="list-style-type: none"> ☒ Adaptive Cruise Control (ACC) with Low Speed Follow P. 445 ACC cannot be set. <ul style="list-style-type: none"> ☒ Adaptive Cruise Control (ACC) with Low Speed Follow P. 445

Message	Condition	Explanation
 <p>(Amber)</p>	<ul style="list-style-type: none"> • Appears if the automatic brake hold is automatically cancelled while it is in operation. • Appears if ACC is cancelled while your vehicle is automatically stopped by ACC. • Appears if the single pedal control is cancelled while your vehicle is automatically stopped by the single pedal control. 	<ul style="list-style-type: none"> • Immediately depress the brake pedal. • Immediately depress the brake pedal. • Immediately depress the brake pedal.
 <p>(White)</p>	<ul style="list-style-type: none"> • Appears when the vehicle is brought into a travelable state by Auto Power On. 	<ul style="list-style-type: none"> • Depress the brake pedal to start the vehicle.
	<ul style="list-style-type: none"> • Appears when the automatic brake hold system is turned off. 	<p>➤ Automatic Brake Hold P. 501</p>





Message	Condition	Explanation
	<ul style="list-style-type: none"> Appears when the automatic brake hold button is pressed without wearing the driver's seat belt. 	<ul style="list-style-type: none"> Fasten the driver's seat belt. <ul style="list-style-type: none"> ➤ Automatic Brake Hold P. 501
	<ul style="list-style-type: none"> Appears when the automatic brake hold button is pressed without depressing the brake pedal while the automatic brake hold is in operation. 	<ul style="list-style-type: none"> Press the automatic brake hold button with the brake pedal depressed. <ul style="list-style-type: none"> ➤ Automatic Brake Hold P. 501
	<ul style="list-style-type: none"> Appears when the parking brake is applied automatically while it is in operation. 	<ul style="list-style-type: none"> ➤ Automatic Brake Hold P. 501 ➤ Parking Brake P. 497 ➤ Single Pedal Control P. 396
	<ul style="list-style-type: none"> Appears when the parking brake is applied automatically while ACC is in operation. 	<ul style="list-style-type: none"> ACC has been automatically cancelled. <ul style="list-style-type: none"> ➤ Adaptive Cruise Control (ACC) with Low Speed Follow P. 445 ➤ Parking Brake P. 497
	<ul style="list-style-type: none"> Appears when pressing the RES/+ or SET/- button while the parking brake is applied. 	<ul style="list-style-type: none"> ACC cannot be set. <ul style="list-style-type: none"> ➤ Adaptive Cruise Control (ACC) with Low Speed Follow P. 445 ➤ Parking Brake P. 497
	<ul style="list-style-type: none"> Appears when the single pedal control system is automatically turned off while the parking brake is engaged. 	<p>—</p>



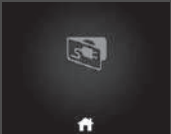

Message	Condition	Explanation
	<ul style="list-style-type: none"> • Appears when the electric parking brake switch is pressed without depressing the brake pedal while the electric parking brake is in operation. 	<ul style="list-style-type: none"> • Press the electric parking brake switch with the brake pedal depressed. <ul style="list-style-type: none"> ➤ Parking Brake P. 497
	<ul style="list-style-type: none"> • Appears as soon as a problem is detected in the keyless access system or keyless starting system. 	<ul style="list-style-type: none"> • Appears constantly - Have your vehicle checked by a dealer.
	<ul style="list-style-type: none"> • Appears when you close the door with the power mode in ON without the keyless remote inside the vehicle. • Appears when you depress the brake pedal after Auto Power ON without the keyless remote inside the vehicle. 	<ul style="list-style-type: none"> • Disappears when you bring the keyless remote back inside the vehicle, and close the door. <ul style="list-style-type: none"> ➤ Keyless Remote Reminder P. 200 • Disappears when you bring the keyless remote back inside the vehicle, and depress the brake pedal after Auto Power ON.
	<ul style="list-style-type: none"> • Appears when the keyless remote battery becomes weak. 	<ul style="list-style-type: none"> ➤ Replacing the Button Battery P. 614

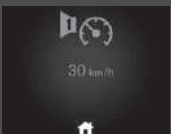



Message	Condition	Explanation
	<ul style="list-style-type: none"> • Appears when the power mode is in ACCESSORY. • Appears after the driver's door is opened when the power mode is in ACCESSORY. 	<p>—</p> <ul style="list-style-type: none"> • Change the power mode to VEHICLE OFF. ➤ POWER Button P. 197
	<ul style="list-style-type: none"> • Appears if the keyless remote's battery is too weak to turn on the power system or the key is not within operating range to turn on the power system. The beeper sounds six times. 	<ul style="list-style-type: none"> • Bring the back of the keyless remote into contact with the POWER button. ➤ If the Keyless Remote Battery is Weak P. 645
	<ul style="list-style-type: none"> • Appears if you press the POWER button while the vehicle is moving. 	<p>➤ Emergency Power System Off P. 646</p>
	<ul style="list-style-type: none"> • Appears when you press and hold the N button for more than 2 seconds. 	<ul style="list-style-type: none"> • Disappears when you set the shift position to other than N. ➤ If you want to keep the transmission in N position (car wash mode) P. 389



Message	Condition	Explanation
	<ul style="list-style-type: none"> • Appears when you change to N, and press the POWER button within five seconds. • Appears when the vehicle is stopped with the driver's seat belt unfastened and there is a chance that the vehicle may roll unintentionally. • Appears when you set the power mode to OFF while driving. 	<ul style="list-style-type: none"> • The shift position remains in N for 15 minutes, then automatically switches to P. <ul style="list-style-type: none"> ▶ If you want to keep the transmission in N position (car wash mode) P. 389 • Press the P button before releasing the brake pedal when idling, parking or exiting the vehicle. <ul style="list-style-type: none"> ▶ Shift Operation P. 386 • Immediately stop in a safe place, set the parking brake, then restart the power system. If the message disappears, continue driving.
	<ul style="list-style-type: none"> • Appears when the High Voltage battery and other system control temperatures are too low to operate (approx. -30°C or below). 	<ul style="list-style-type: none"> • You must wait for an increase in the ambient temperature or move the vehicle to a warmer location. • Contact a dealer if necessary.

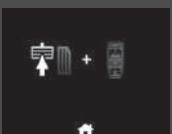

Message	Condition	Explanation
	<ul style="list-style-type: none"> • Appears when the power system temperature is high. 	<ul style="list-style-type: none"> • Your vehicle has less ability to accelerate and may be harder to start on an incline. • Park in a safe place, and cool the system down. ➤ Overheating P. 650
	<ul style="list-style-type: none"> • Appears when the High Voltage battery temperature is low. 	<ul style="list-style-type: none"> • Your vehicle has less ability to accelerate and may be harder to start on an incline. • In extremely cold climates, keep the vehicle stored in a garage or connect the charging connector. ➤ Charge the High Voltage battery using a AC or CCS2 DC charger P. 557
	<ul style="list-style-type: none"> • Appears after the 12-volt battery charging system indicator comes on. 	<ul style="list-style-type: none"> • Your vehicle has less ability to accelerate and may be harder to start on an incline. • Contact a dealer immediately.
	<ul style="list-style-type: none"> • Appears if the power system is in diagnostic mode. 	<ul style="list-style-type: none"> • You may notice a decrease in available power. Have your vehicle checked by a dealer. • As a result of diagnostics, the power system indicator may come on. ➤ Power System Indicator P. 111
	<ul style="list-style-type: none"> • Appears when the High Voltage battery charge level is extremely low. 	<ul style="list-style-type: none"> • Caused by the low battery charge level - Immediately charge the High Voltage battery.

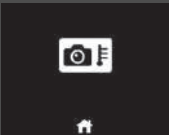

Message	Condition	Explanation
	<ul style="list-style-type: none"> • Appears when there is a problem with the standard plug-in charging system or the charging station outlet. • Appears when there is a problem with the quick plug-in charging system or the charging station outlet. 	<ul style="list-style-type: none"> • This message only - There may be a problem with the charging station outlet. Refer to the instructions provided at the station or consult a qualified technician. If the outlet works properly, have the vehicle checked by a dealer. • Comes on with the POWER SYSTEM indicator - Have your vehicle checked by a dealer. • This message only - There may be a problem with the charging station outlet. Refer to the instructions provided at the station or consult a qualified technician. If the outlet works properly, have your vehicle checked by a dealer. • Comes on with the POWER SYSTEM indicator - Have your vehicle checked by a dealer.
	<ul style="list-style-type: none"> • Appears when the charge lid is open. 	<ul style="list-style-type: none"> • Close the charge lid.  Charging P. 556
	<ul style="list-style-type: none"> • Appears when the vehicle speed reaches the set speed. You can set two different speeds for the alarm. 	<ul style="list-style-type: none"> •  Speed Alarm P. 163





Message	Condition	Explanation
	<ul style="list-style-type: none"> Appears when there is a problem with the pop-up hood system. 	<ul style="list-style-type: none"> Have your vehicle checked by a dealer. <ul style="list-style-type: none"> ➤ Pop-up Hood System P. 72
	<ul style="list-style-type: none"> Appears when you depress the accelerator pedal while the shift position is in N. 	<ul style="list-style-type: none"> Remove your foot off the accelerator pedal. When driving, depress the brake pedal and operate the shift position.
	<ul style="list-style-type: none"> Appears when you repeatedly change the shift position between P and other positions in short period. 	<ul style="list-style-type: none"> Take some time before changing the shift position.
	<ul style="list-style-type: none"> Appears when you try to change the shift position without releasing your foot off the accelerator pedal. 	<ul style="list-style-type: none"> Release your foot off the accelerator pedal, then select a shift button.

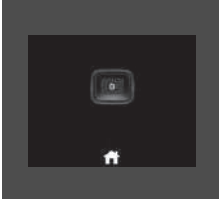

Message	Condition	Explanation
	<ul style="list-style-type: none"> • Appears when the P button is pressed while the vehicle is moving. • Appears if you put the transmission into R while the vehicle is moving forward, or into D while the vehicle is reversing. 	<ul style="list-style-type: none"> • Make sure that the vehicle comes to a stop before operating the shift button.
	<ul style="list-style-type: none"> • Appears when you try to change the shift position without depressing the brake pedal. 	<ul style="list-style-type: none"> • Depress the brake pedal, then select a shift button.
	<ul style="list-style-type: none"> • Appears if there is a problem with the auto high-beam. 	<ul style="list-style-type: none"> • Manually operate the headlight switch. • If you are driving with the high beam headlights when this happens, the headlights are changed to low beams.
	<ul style="list-style-type: none"> • Appears if anything covers the radar sensor cover and prevents the sensor from detecting a vehicle in front. • May appear when driving in bad weather (rain, snow, fog, etc.) 	<ul style="list-style-type: none"> • When the radar sensor gets dirty, stop your vehicle in a safe place, and wipe off dirt using a soft cloth. The message may take some time to go off. • Have your vehicle checked by a dealer if the message does not disappear even after you clean the sensor cover. <p>  Radar Sensor P. 494  Honda Sensing P. 425 </p>





Message	Condition	Explanation
	<ul style="list-style-type: none"> • Appears if anything covers the sonar sensor and prevents the sensor from detecting. • May appear when driving in bad weather (rain, snow, fog, etc.) 	<ul style="list-style-type: none"> • When the sonar sensor gets dirty, stop your vehicle in a safe place, and wipe off dirt using a soft cloth. • Have your vehicle checked by a dealer if the message does not disappear even after you clean the sensor cover. <ul style="list-style-type: none"> ➤ Sonar Sensors P. 495 ➤ Honda Sensing P. 425
	<ul style="list-style-type: none"> • Appears if the temperature inside the front sensor camera is too high and some driver assist systems cannot be activated. 	<ul style="list-style-type: none"> • Use the climate control system to cool down the camera. • Disappears - The camera has been cooled down and the systems are activated normally. <ul style="list-style-type: none"> ➤ Front Sensor Camera P. 492 ➤ Honda Sensing P. 425
	<ul style="list-style-type: none"> • Appears if the area around the front sensor camera is blocked by dirt, mud, etc. and be prevented from detecting a vehicle in front. • May appear when driving in bad weather (rain, snow, fog, etc.) 	<ul style="list-style-type: none"> • When the front window gets dirty, stop your vehicle in a safe place, and wipe it off with a soft cloth. • Have your vehicle checked by a dealer if the message does not disappear even after you cleaned the area around the camera. <ul style="list-style-type: none"> ➤ Front Sensor Camera P. 492 ➤ Honda Sensing P. 425

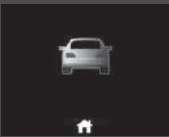

Message	Condition	Explanation
	<ul style="list-style-type: none"> • Appears when the distance between your vehicle and the vehicle ahead of you is too close while ACC is in operation. 	<ul style="list-style-type: none"> • ACC has been automatically cancelled. <ul style="list-style-type: none"> ▶ Adaptive Cruise Control (ACC) with Low Speed Follow P. 445
	<ul style="list-style-type: none"> • Appears when pressing the RES/+ or SET/- button while the distance between your vehicle and the vehicle ahead of you is too close. 	<ul style="list-style-type: none"> • ACC cannot be set. <ul style="list-style-type: none"> ▶ Adaptive Cruise Control (ACC) with Low Speed Follow P. 445
	<ul style="list-style-type: none"> • Appears when the speed of the vehicle is too high for you to set ACC. 	<ul style="list-style-type: none"> • Reduce the speed, then set ACC. <ul style="list-style-type: none"> ▶ Adaptive Cruise Control (ACC) with Low Speed Follow P. 445
	<ul style="list-style-type: none"> • Appears when ACC is cancelled due to excessive high vehicle speed. 	<ul style="list-style-type: none"> • Reduce the speed, then reset ACC. <ul style="list-style-type: none"> ▶ Adaptive Cruise Control (ACC) with Low Speed Follow P. 445
	<ul style="list-style-type: none"> • Appears if ACC cannot be set due to repeated deceleration, driving on a long downward slope, or excess vehicle weight. 	<ul style="list-style-type: none"> • Wait awhile, then reset ACC. <ul style="list-style-type: none"> ▶ Adaptive Cruise Control (ACC) with Low Speed Follow P. 445
	<ul style="list-style-type: none"> • Appears just before ACC is automatically cancelled due to repeated deceleration, driving on a long downward slope, or excess vehicle weight. (Will automatically open until the distance between your vehicle and the vehicle ahead is the maximum set in distance settings.) 	<ul style="list-style-type: none"> • ACC will be cancelled automatically. <ul style="list-style-type: none"> ▶ Adaptive Cruise Control (ACC) with Low Speed Follow P. 445

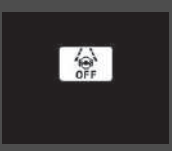



Message	Condition	Explanation
	<ul style="list-style-type: none"> Appears when the vehicle ahead of you resumes driving, after your vehicle has been stopped automatically by ACC. 	<ul style="list-style-type: none"> Press the RES/+ or SET/- button or depress the accelerator pedal to resume. <ul style="list-style-type: none"> ➤ Adaptive Cruise Control (ACC) with Low Speed Follow P. 445
	<ul style="list-style-type: none"> Appears when the shift position is changed to any position other than D while ACC is in operation. 	<ul style="list-style-type: none"> ACC has been automatically cancelled. <ul style="list-style-type: none"> ➤ Adaptive Cruise Control (ACC) with Low Speed Follow P. 445
	<ul style="list-style-type: none"> Appears when pressing the RES/+ or SET/- button while the shift position is in any position other than D. 	<ul style="list-style-type: none"> ACC cannot be set. <ul style="list-style-type: none"> ➤ Adaptive Cruise Control (ACC) with Low Speed Follow P. 445
	<ul style="list-style-type: none"> Appears when the vehicle is stopped on a very steep slope while ACC is in operation. 	<ul style="list-style-type: none"> ACC has been automatically cancelled. <ul style="list-style-type: none"> ➤ Adaptive Cruise Control (ACC) with Low Speed Follow P. 445
	<ul style="list-style-type: none"> Appears when pressing the RES/+ or SET/- button while the vehicle is stopped on a very steep slope. 	<ul style="list-style-type: none"> ACC cannot be set. <ul style="list-style-type: none"> ➤ Adaptive Cruise Control (ACC) with Low Speed Follow P. 445

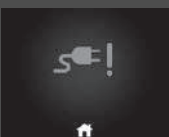

Message	Condition	Explanation
	<ul style="list-style-type: none"> Appears if the VSA or traction control function operates while ACC is in operation. 	<ul style="list-style-type: none"> ACC has been automatically cancelled. <ul style="list-style-type: none"> ➤ Adaptive Cruise Control (ACC) with Low Speed Follow P. 445
	<ul style="list-style-type: none"> Appears when pressing the RES/+ or SET/- button while the vehicle is moving and the brake pedal is depressed. 	<ul style="list-style-type: none"> ACC cannot be set. <ul style="list-style-type: none"> ➤ Adaptive Cruise Control (ACC) with Low Speed Follow P. 445
	<ul style="list-style-type: none"> Flashes when the system senses a likely collision. The beeper sounds. 	<ul style="list-style-type: none"> Take appropriate action to prevent a collision (apply the brakes, change lanes, etc.) <ul style="list-style-type: none"> ➤ Adaptive Cruise Control (ACC) with Low Speed Follow P. 445 ➤ Collision Mitigation Braking System (CMBS) P. 428 ➤ Low Speed Braking Control P. 439
	<ul style="list-style-type: none"> Appears when the low speed braking control system is activated. 	<p>—</p>





Message	Condition	Explanation
	<ul style="list-style-type: none"> • Appears when Lead Car Departure Notification System is on. 	<p>➤ Lead Car Departure Notification System P. 482</p>
 <p>(Amber)</p>	<ul style="list-style-type: none"> • Appears if the vehicle is about to veer out of the detected lane. 	<ul style="list-style-type: none"> • Take direct control of the steering and keep the vehicle in the centre of the lane. The message will disappear after a while. <ul style="list-style-type: none"> ➤ Lane Keeping Assist System (LKAS) P. 465 ➤ Road Departure Mitigation System P. 476
 <p>(Red)</p>	<ul style="list-style-type: none"> • Appears if the driver is merely resting his or her hands on the steering wheel or is not holding the steering wheel at all and the vehicle is about to veer out of the detected lane. A beeper will also sound. • Blinks if the driver is merely resting his or her hands on the steering wheel or is not holding the steering wheel at all. A beeper will also sound. If the driver continues to drive in this manner, the beeper will turn to a single long beep and LKAS will be deactivated. 	<ul style="list-style-type: none"> • Take direct control of the steering and keep the vehicle in the centre of the lane. The message will disappear after a while. <ul style="list-style-type: none"> ➤ Lane Keeping Assist System (LKAS) P. 465 • Take direct control of the steering; the message will disappear. <ul style="list-style-type: none"> ➤ Lane Keeping Assist System (LKAS) P. 465



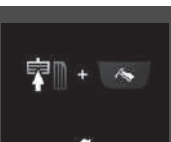
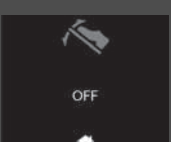

Message	Condition	Explanation
 <p>(White)</p>	<ul style="list-style-type: none"> Appears when the vehicle is likely to drive out of a detected lane. The Road Departure Mitigation system also steers the vehicle to help you remain within your driving lane. 	<ul style="list-style-type: none"> Take direct control of the steering and keep the vehicle in the centre of the lane. The message will disappear after a while. <ul style="list-style-type: none"> ► Road Departure Mitigation System P. 476
	<ul style="list-style-type: none"> Appears when the LKAS is in operation, or the LKAS button is pressed, but there is a problem with a system related to the LKAS. The LKAS cancels automatically. The beeper sounds simultaneously. 	<ul style="list-style-type: none"> If any other system indicators come on, such as the VSA, ABS and brake system, take appropriate action. <ul style="list-style-type: none"> ► Indicators P. 106
	<ul style="list-style-type: none"> Appears when the SET/-, RES/+, CANCEL, interval or LIM button is pressed while ACC, adjustable speed limiter or intelligent speed limiter is off. 	<ul style="list-style-type: none"> After pressing the  button, press the SET/-, RES/+, CANCEL, interval or LIM button. <ul style="list-style-type: none"> ► Adjustable Speed Limiter P. 403 ► Intelligent Speed Limiter P. 408 ► Adaptive Cruise Control (ACC) with Low Speed Follow P. 445
	<ul style="list-style-type: none"> Appears when the interval button is pressed in adjustable speed limiter/intelligent speed limiter mode. 	<ul style="list-style-type: none"> After switching to ACC, press the interval button. <ul style="list-style-type: none"> ► Adjustable Speed Limiter P. 403 ► Intelligent Speed Limiter P. 408 ► Adaptive Cruise Control (ACC) with Low Speed Follow P. 445

Message	Condition	Explanation
	<ul style="list-style-type: none"> • Appears when Auto Power OFF is disabled. 	<p>➤ POWER Button P. 197</p>
	<ul style="list-style-type: none"> • Appears when the charging connector has failed. 	<ul style="list-style-type: none"> • Disconnect the charging connector using the release cord. ➤ If You Cannot Disengage the Charging Connector P. 669
 <p>(Amber)</p>	<ul style="list-style-type: none"> • Appears when the charging connector is connected to the inlet. 	<ul style="list-style-type: none"> • The vehicle does not move while the charging connector is plugged into the inlet.
 <p>(White)</p>	<ul style="list-style-type: none"> • Appears after you set the power mode to VEHICLE OFF without connecting the charging connector while the ambient temperature is low. 	<ul style="list-style-type: none"> • Connecting the charging connector improves cold startability.



Message	Condition	Explanation
	<ul style="list-style-type: none"> • Appears when charging is not available due to high power consumption. 	<ul style="list-style-type: none"> • Turn up/down the air conditioning if you wish to charge the High Voltage battery.
	<ul style="list-style-type: none"> • Appears when charging is not available due to high power consumption. 	<ul style="list-style-type: none"> • Reduce the power consumption of AC outlet if you wish to charge the High Voltage battery.
	<ul style="list-style-type: none"> • Appears when charging is not available due to high power consumption. 	<ul style="list-style-type: none"> • Turn up/down the air conditioning or reduce the power consumption of the AC outlet if you wish to charge the High Voltage battery.
	<ul style="list-style-type: none"> • Appears when charging is not available due to high power consumption. 	<ul style="list-style-type: none"> • Reduce the power consumption of the vehicle if you wish to charge the High Voltage battery.

Message	Condition	Explanation
	<ul style="list-style-type: none"> Appears when the single pedal control system is temporarily unable to be used. 	<ul style="list-style-type: none"> Wait awhile, then turn on the single pedal control system.
	<ul style="list-style-type: none"> Appears when the single pedal control system cannot be used because the Honda parking pilot is activated. 	<ul style="list-style-type: none"> Turn off the Honda parking pilot, then turn on the single pedal control system.
	<ul style="list-style-type: none"> Appears when the single pedal control button is pressed while the driver's seat belt is unfastened. 	<ul style="list-style-type: none"> Fasten the seat belt, then press the single pedal control button.
	<ul style="list-style-type: none"> Appears when the single pedal control button is pressed without depressing the brake pedal. 	<ul style="list-style-type: none"> Depress the brake pedal then press the single pedal control button.
	<ul style="list-style-type: none"> Appears when the single pedal control system operation is automatically cancelled. 	<ul style="list-style-type: none"> Wait awhile, then turn the single pedal control system on.
	<ul style="list-style-type: none"> Appears when the single pedal control system is automatically turned off when ACC is set. 	—
	<ul style="list-style-type: none"> Appears when the single pedal control system is automatically turned off when the Honda parking pilot is activated. 	—

Message	Condition	Explanation
	<ul style="list-style-type: none"> • Appears when the automatic brake hold is changed to single pedal control. 	<p>—</p>
	<ul style="list-style-type: none"> • Appears when deceleration has decreased. 	<p>➤ Single Pedal Control P. 396</p>
	<ul style="list-style-type: none"> • Appears when the automatic brake hold system cannot be used because the single pedal control is activated. 	<p>—</p>
	<ul style="list-style-type: none"> • Appears when there is a problem with the digital key system. 	<ul style="list-style-type: none"> • Have your vehicle checked by a dealer.

Message	Condition	Explanation
	<ul style="list-style-type: none"> • Appears when the driver's door is opened when the power mode is in ON. 	<ul style="list-style-type: none"> • Set the power mode to OFF and carry the key when getting off the vehicle.
	<ul style="list-style-type: none"> • Appears before exiting the vehicle, if a rear door was opened shortly before the vehicle was turned on, to remind you to check for any passengers or items present in the rear seats when you leave the vehicle. 	<ul style="list-style-type: none"> • Check the rear seat for passengers or items before exiting the vehicle.  Rear Seat Reminder P. 229
	<ul style="list-style-type: none"> • Appears when there is a problem with the Honda Parking Pilot System. 	<ul style="list-style-type: none"> • Have your vehicle checked by a dealer.

Models with service reminder system

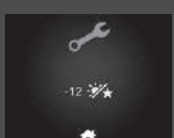
Message	Condition	Explanation
	<ul style="list-style-type: none"> • Appears when any of the service items is required in less than 30 days. 	<ul style="list-style-type: none"> • The remaining days will be counted down per day. ➤ Service Reminder System* P. 576
	<ul style="list-style-type: none"> • Appears when any of the service items is required in less than 10 days. 	<ul style="list-style-type: none"> • Have the indicated service performed as soon as possible. ➤ Service Reminder System* P. 576
	<ul style="list-style-type: none"> • Appears when the indicated maintenance service is still not done after the remaining time reaches 0. 	<ul style="list-style-type: none"> • Your vehicle has passed the service required point. Immediately have the service performed and make sure to reset the service reminder. ➤ Service Reminder System* P. 576

* Not available on all models

Gauges

Gauges include the speedometer, High Voltage battery charge level gauge, **POWER/CHARGE** gauge, and related indicators. They are displayed when the power mode is in ON.

■ Speedometer

Displays your driving speed in km/h or mph.

■ High Voltage Battery Charge Level Gauge

Shows the remaining High Voltage battery charge level.

■ POWER/CHARGE Gauge

■ Electric motor

The degree to which the electric motor is being powered is displayed by the readings on the **POWER** side.

■ Battery charge in progress

The degree to which the High Voltage battery is being charged is displayed by the readings on the **CHARGE** side.

■ Odometer

Shows the total number of kilometres or miles that your vehicle has accumulated.

⌘ Speedometer

You can set the speedometer and the displayed measurements to read in either km/h or mph.

➤ **Unit Change** P. 168

⌘ High Voltage Battery Charge Level Gauge

The High Voltage battery charge level may decrease under the following conditions:

- When the 12-volt battery has been replaced.
- When the 12-volt battery has been disconnected.
- When the High Voltage battery control system corrects its reading.

The charge level reading will be corrected automatically while driving.

Changes in the temperature of the High Voltage battery can increase or decrease the battery's charging capacity. If temperature changes cause the battery's capacity to change, the number of indicators in the battery charge level gauge may also change, even if the amount of charging remains the same.

■ Outside Temperature

Shows the outside temperature in Celsius.

If the outside temperature has been below 3°C at the time you set the power mode to ON, the outside temperature blinks for 10 seconds.

■ Adjusting the outside temperature display

Adjust the temperature reading by up to ±3°C if the temperature reading seems incorrect.

■ Traffic Sign Recognition System

Shows certain detected traffic signs while driving.

The indicator blinks when the maximum speed of the traffic sign detected by the Traffic Sign Recognition System is exceeded.

■ Current Mode for ACC with Low Speed Follow and the LKAS

Shows the current mode for ACC with Low Speed Follow and the LKAS.

► **Adaptive Cruise Control (ACC) with Low Speed Follow** P. 445

► **Lane Keeping Assist System (LKAS)** P. 465

☒ Outside Temperature

The temperature sensor is in the front bumper. Road heat and exhaust from another vehicle can affect the temperature reading when your vehicle speed is less than 30 km/h (19 mph).

It may take several minutes for the display to be updated after the temperature reading has stabilised.

You can adjust the temperature reading.

► **Customized Features** P. 323

☒ Traffic Sign Recognition System

You can turn the Traffic Sign Recognition System Over Speed Warning on and off.

► **Customized Features** P. 323

Driver Information Interface

The driver information interface shows information such as the estimated travelable distance and energy economy of the vehicle. It also displays messages such as warnings and other helpful information.

■ Switching the Display

■ Accessing contents in the display

Press the  (home) button, then roll the left selector wheel to scroll to the content you want to see. Press the left selector wheel to see detailed information.

☒ Switching the Display

To go back to the previous screen, press the  (back) button.

You can add or delete the meter contents.

☒ **Customize Display** P. 167

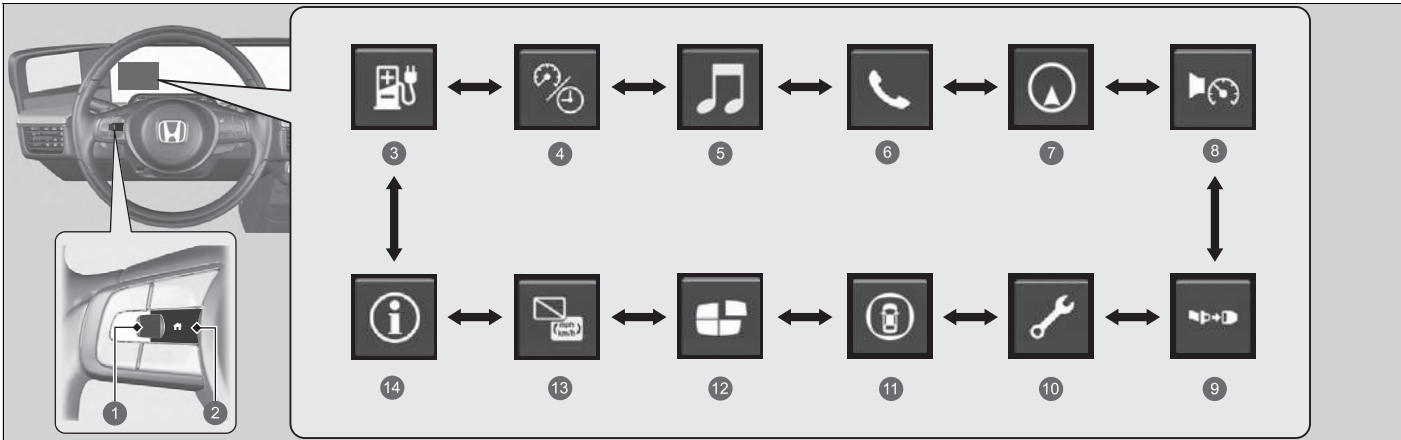

Instrument Panel

- ① Left Selector Wheel
- ② (home) Button
- ③ Range & Energy P. 158
- ④ Speed & Time P. 160
- ⑤ Audio P. 161
- ⑥ Phone P. 161
- ⑦ Navigation P. 162
- ⑧ Speed Alarm P. 163
- ⑨ Seat Belts P. 164
- ⑩ Maintenance* P. 164
- ⑪ Safety Support P. 165
- ⑫ Customize Display P. 167
- ⑬ No Content/Unit Change P. 168
- ⑭ Information P. 168

* Not available on all models

■ Range / Energy Consumption / Trip Meter

Roll the left selector wheel to switch between trip meter A and trip meter B.

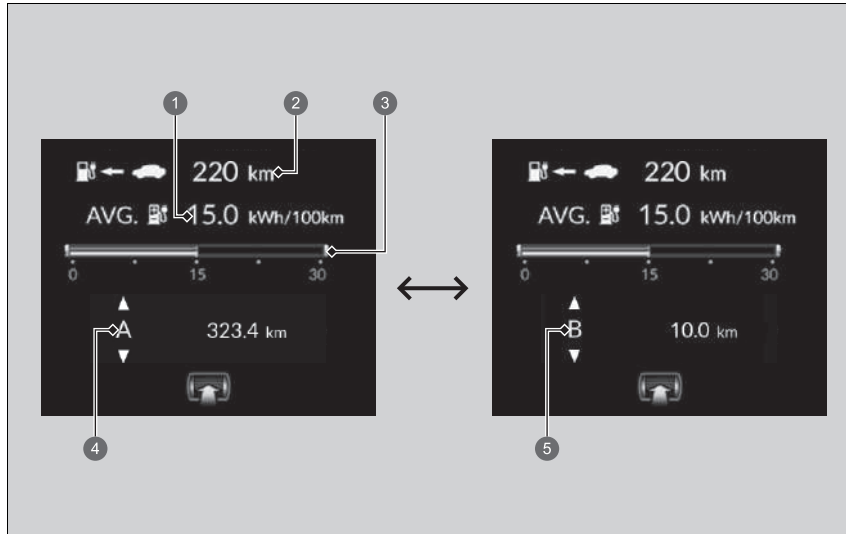

- 1 Average Energy Consumption
- 2 Range
- 3 Instant Energy Consumption
- 4 Trip Meter A
- 5 Trip Meter B

■ Trip meter

Shows the total number of kilometres or miles driven since the last reset. Meters A and B can be used to measure two separate trips.

Resetting a trip meter

To reset the trip meter, display it, press the left selector wheel and then select **Reset**. The trip meter is reset to **0.0**.

■ Average energy consumption

Shows the estimated average energy consumption of each trip meter in kWh/100km or miles/kWh. The display is updated at set intervals. When a trip meter is reset, the average energy consumption is also reset.

■ Instant energy consumption

Shows the instant energy consumption as a bar graph in kWh/100km or miles/kWh.

■ Range

Shows the estimated distance you can travel on the remaining power. This estimate is based on the energy consumption of your previous trips and the remaining charge of the High Voltage battery.

☒ Trip meter

Switch between trip meter A and trip meter B by rolling the left selector wheel.

☒ Average energy consumption

You can change when to reset the average energy consumption.

➤ **Customized Features** P. 323

☒ Range

The driving range displayed is only an estimate and may differ to the actual distance the vehicle can travel.

■ Speed & Time

Roll the left selector wheel to switch between trip meter A and trip meter B.

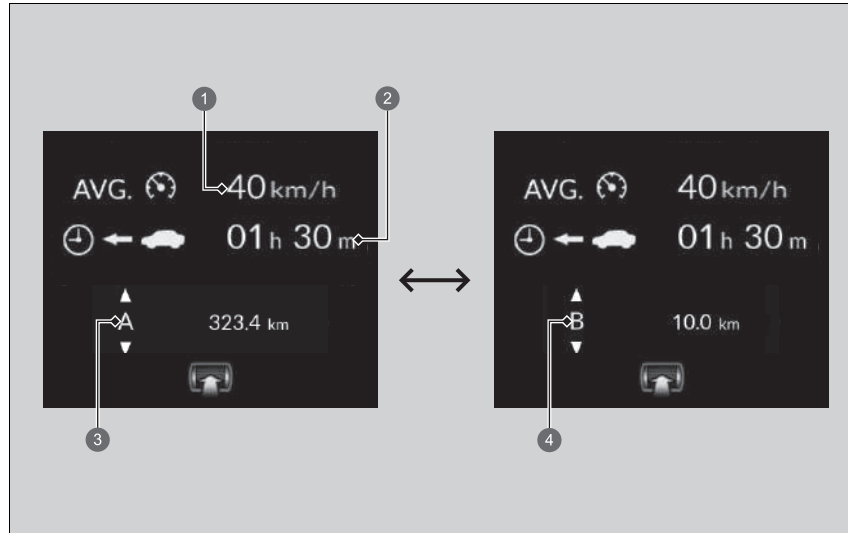

- ① Average Speed
- ② Elapsed Time
- ③ Trip meter A
- ④ Trip meter B

■ Trip meter

➤ **Trip meter** P. 159

■ Elapsed time

Shows the time elapsed since Trip A or Trip B was reset.

■ Average speed

Shows the average speed in km/h or mph since Trip A or Trip B was reset.

■ Audio

Shows the current audio information.

➤ **Basic Operation** P. 257

■ Phone

Shows the current phone information.

➤ **Hands-Free Telephone System** P. 339

⌘ Elapsed time

You can change when to reset the elapsed time.

➤ **Customized Features** P. 323

⌘ Average speed

You can change when to reset the average speed.

➤ **Customized Features** P. 323

■ Navigation

■ Compass

Shows the compass screen.

■ Turn-by-turn directions

When driving guidance is provided by the navigation system, Android Auto or Apple CarPlay, turn-by-turn directions to your destination appear.

- **Refer to the Navigation System Manual**
- **Android Auto™** P. 309
- **Apple CarPlay** P. 305

☒ Navigation

You can select whether to have the turn-by-turn display come on or not during the route guidance.

- **Customized Features** P. 323

When the compass or turn-by-turn directions are displayed, you can control some navigation system functions on the driver information interface by scrolling the left selector wheel.

- **Refer to the Navigation System Manual**

Turn-by-turn directions may not be available for all apps.

Speed Alarm

Sets the speed alarm on and changes the speed alarm setting.

Roll the left selector wheel, the speed alarm setting changes as follows:

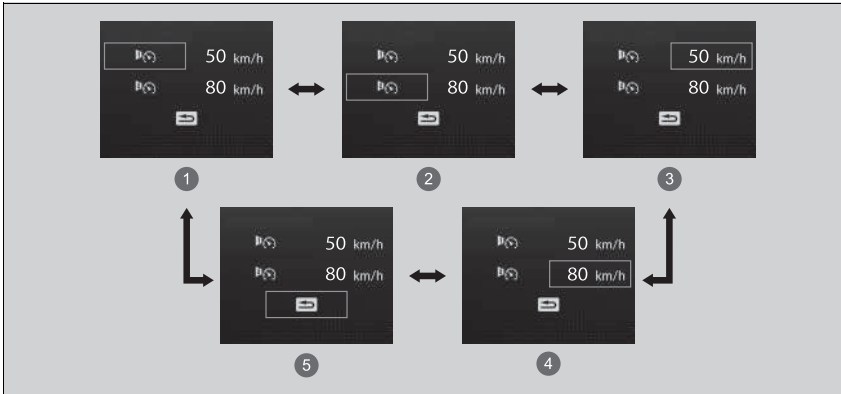

- ① Speed Alarm 1 On/Off*1
- ② Speed Alarm 2 On/Off*1
- ③ Speed Alarm 1 Speed Setting [50 km/h (30mph)*1]
- ④ Speed Alarm 2 Speed Setting [80 km/h (50mph)*1]
- ⑤ Back

*1:Default Setting

■ Seat Belts

Occurs, under specified conditions, when seat belts are latched or unlatched.

▶ **Seat Belt Reminder** P. 48

■ Maintenance*

Shows the service reminder system.

▶ **Service Reminder System*** P. 576

■ Safety Support

Indicates the status of the Road Departure Mitigation system, blind spot information system, Low Speed Braking Control and CMBS such as On, Off, or Failure, by colour and letters.

The following colours indicate the status of any of the above mentioned systems:

- Green: The system is on.
- Grey: The system is off.
- Amber: There is a problem with the system.

☒ Safety Support

If a system is indicated by the colour amber, have your vehicle checked by a dealer immediately.

To turn on or off each system, first rotate the left selector wheel to switch displays. From the next display you can select which system to turn on or off.

☒ **Road Departure Mitigation On and Off**

P. 479

☒ **Blind spot information On and Off** P. 424

☒ **System On and Off** P. 442

☒ **CMBS On and Off** P. 432

You can also confirm the status of each function by the colour of the safety support indicator.

☒ **Safety Support Indicator (Amber)** P. 125

☒ **Safety Support Indicator (Green/Grey)**

P. 128

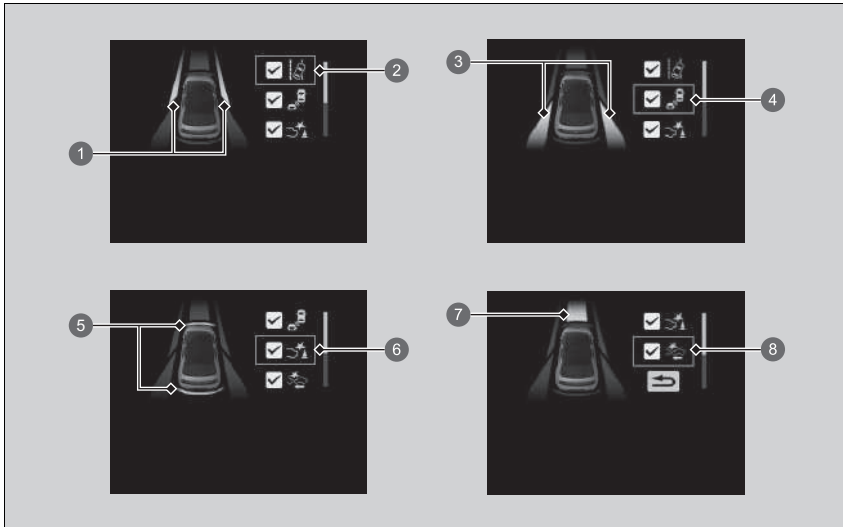

- ① Area Info for the Road Departure Mitigation system
- ② Road Departure Mitigation system Icon and Status Info
- ③ Area Info for the Blind Spot Information System
- ④ Blind Spot Information System Icon and Status Info
- ⑤ Area Info for the Low Speed Braking Control
- ⑥ Low Speed Braking Control Icon and Status Info
- ⑦ Area Info for the CMBS
- ⑧ CMBS Icon and Status Info



■ Customize Display

Change the settings to your liking.

■ Arrange content

You can choose which icons to display on the home screen.



1. Roll the left selector wheel to scroll to select , then press the left selector wheel.
2. Roll the left selector wheel to scroll to select , then press the left selector wheel.



3. Roll the left selector wheel to scroll between icons, then press the left selector wheel to check or uncheck them.

☒ Customize Display

Icons that are grey cannot be removed from the home screen.

■ Unit Change

Enables you to show another speed unit on the driver information interface and set the displayed measurements to read in either km/h or mph.

Press and hold the left selector wheel when you select  on the driver information interface. Each time you do this, the unit will change from km/h to mph or vice versa. After this, a confirmation screen will appear for a few seconds.

■ Information

➤ **Driver Information Interface Warning and Information Messages** P. 130

■ Remaining Battery



Displays the current status of the High Voltage battery.

The colour of the circle represents the current High Voltage battery status.

- Green: Charging
- Amber: High Voltage battery is running low (approximately 15% left)
- White: When other than the above or when fully charged

⊗ Remaining Battery

If amber is displayed, charge the High Voltage battery as soon as possible.

■ Pre-Conditioning Climate Schedule



Displays the current status of the timer climate control system.

▶ **Pre-Conditioning Climate Schedule Setting** P. 319

■ Charging Time Remaining

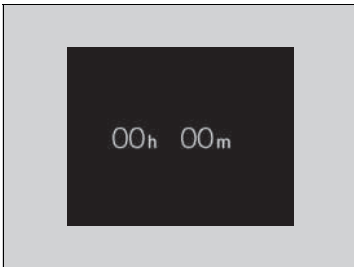

Displays the current charging status.

▶ **Charging** P. 556

Controls

This chapter explains how to operate the various controls necessary for driving.

Locking and Unlocking the Doors	
Key	172
Low Keyless Remote Signal Strength	174
Locking/Unlocking the Doors from the Outside	175
Locking/Unlocking the Doors from the Inside	182
Childproof Door Locks	184
NFC Marks	185
Tailgate	186
Security System	
Immobilizer System	188

Security System Alarm	189
Ultrasonic Sensors*	191
Tilt Sensor*	192
Super Locking*	193
Windows	194
Operating the Switches Around the Steering Wheel	
POWER Button	197
Lights	201
Auto High-Beam	206
Wipers and Washers	210
Rear Demister Button	213

Adjusting the Steering Wheel	214
Adjustment of Each Type of Mirror	
Centre Camera Mirror System	215
Side Camera Mirror System	220
Seats	226
Interior Convenience Items	234
Climate Control System	246

* Not available on all models

Key

This vehicle comes with the following key:



Use the keys to start and stop the power system, and to lock and unlock all the doors, tailgate, and charge lid.

Built-in Key

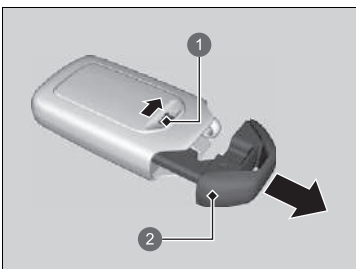

The built-in key can be used to lock/unlock the doors when the keyless remote battery becomes weak and the power door lock/unlock operation is disabled.

To remove the built-in key, slide the release knob and then pull out the key. To reinstall the built-in key, push the built-in key into the keyless remote until it clicks.

- 1 Release Knob
- 2 Built-in Key

Key

All the keys have an immobilizer system. The immobilizer system helps to protect against vehicle theft.

➤ **Immobilizer System** P. 188

Follow the advice below to prevent damage to the keys:

- Do not leave the keys in direct sunlight, or in locations with high temperature or high humidity.
- Do not drop the keys or set heavy objects on them.
- Keep the keys away from liquids, dust and sand.
- Do not take the keys apart except for replacing the battery.

If the circuits in the keys are damaged, the power system may not activate, and the remote transmitter may not work.

If the keys do not work properly, have them inspected by a dealer.

You can turn the climate control system on and off using the keyless remote.

➤ **Remote Climate Pre-Conditioning** P. 249

■ Key Number Tag

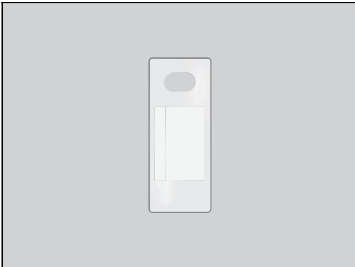

Contains a number that you will need if you purchase a replacement key.

▣ Key Number Tag

Keep the key number tag separate from the key in a safe place outside of your vehicle.
If you wish to purchase an additional key, contact a dealer.

If you lose your key and you cannot activate the power system, contact a dealer.

Low Keyless Remote Signal Strength

The vehicle transmits radio waves to locate the keyless remote when locking/unlocking the doors, tailgate and charge lid, or to activate the power system.

In the following cases, locking/unlocking the doors and tailgate, or activating the power system may be inhibited or operation may be unstable:

- Strong radio waves are being transmitted by nearby equipment.
- You are carrying the keyless remote together with telecommunications equipment, laptop computers, mobile phones, or wireless devices.
- A metallic object is touching or covering the keyless remote.

Low Keyless Remote Signal Strength

Communication between the keyless remote and the vehicle consumes the keyless remote's battery.

Battery life is about two years, but this varies depending on regularity of use.

The battery is consumed whenever the keyless remote is receiving strong radio waves. Avoid placing it near electrical appliances such as televisions and personal computers.

Locking/Unlocking the Doors from the Outside

■ Using the Keyless Access System

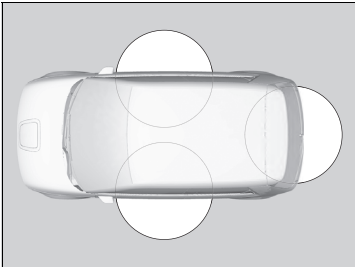

When you carry the keyless remote, the front door outer handles automatically pop in/out and you can lock/unlock the doors and tailgate.

You can lock/unlock the doors and tailgate within a radius of about 80 cm (32 inches) of the front door outer handles or tailgate outer handle.

■ Locking the doors and tailgate

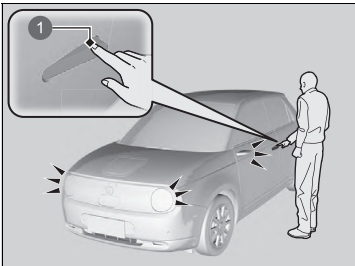

1 Door Lock Sensor

Touch the door lock sensor on the front door or press the lock button on the tailgate.

- ▶ Some exterior lights flash three times; all the doors and tailgate lock; front door outer handles pop in if they are popped out; and the security system sets.

⊠ Using the Keyless Access System

You can lock or unlock doors using the keyless access system only when the power mode is in VEHICLE OFF.

- Do not leave the keyless remote in the vehicle when you get out. Carry it with you.
- Even if you are not carrying the keyless remote, you can lock/unlock the doors and the tailgate while someone else with the remote is within range.
- The door may be locked or unlocked if the door handle is covered with water in heavy rain or in a car wash if the keyless remote is within range.
- If you grip a front door handle or touch a door lock sensor wearing gloves, the door sensor may be slow to respond or may not respond by locking or unlocking the doors.
- After locking the door, you have up to 2 seconds during which you can pull the door handle to confirm whether the door is locked. If you need to unlock the door immediately after locking it, wait at least 2 seconds before gripping the handle, otherwise the door will not unlock.
- The door may not open if you pull it immediately after gripping the door handle. Grip the handle again and confirm that the door is unlocked before pulling the handle.
- Even within the 80 cm (32 inches) radius, you may not be able to lock/unlock the doors and the tailgate with the keyless remote if it is above or below the outside handle.
- The keyless remote may not operate if it is too close to the door and door glass.

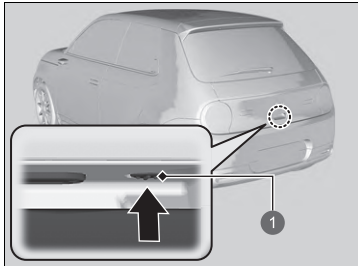

1 Lock Button

■ Unlocking the doors and tailgate

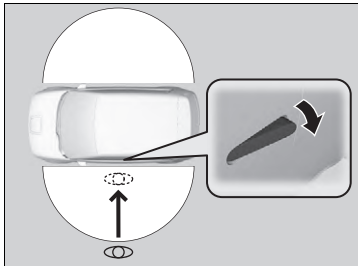

When you walk to the vehicle while carrying the keyless remote, front door outer handles will automatically pop out.

The auto pop-out function activates when all doors are locked, and the keyless remote is within a 2 m (6.5 feet) radius of the outside front door outer handles.

▶▶ Using the Keyless Access System

If you do not open a door or the tailgate within 30 seconds of unlocking the vehicle, the doors and tailgate will automatically relock and the front door outer handle of the doors will automatically pop back in.

If you lock the doors and then keep the keyless remote within the detection range for more than 2 minutes, the auto pop-out function will be disabled. If the function is disabled, pop out the handle manually or use the unlock button on the keyless remote.

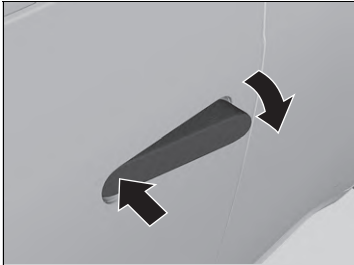

Pushing out the front door outer handle manually:

Push the front side inwards.

- ▶ When the front door outer handle doesn't pop-out automatically, push the front side inwards.

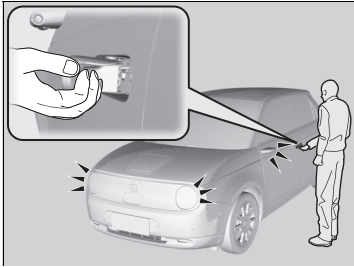

Grab the front door outer handle:

- ▶ All the doors and tailgate unlock.
- ▶ Some exterior light flash once.

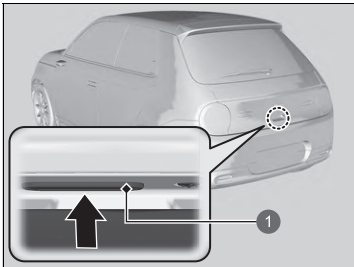

Press the tailgate outer handle:

- ▶ The tailgate and all doors unlock.
- ▶ Some exterior lights flash once.
- ▶ Front door outer handles pop out.

▶ **Opening/Closing the Tailgate** P. 187

① Outer Handle

Using the Keyless Access System

If you walk away from the vehicle when the power system is on, the auto pop-out function will not work.

If you lock the doors and tailgate, and take the keyless remote out of the 2 m (6.5 feet) detection range and then bring it back into the range within 10 seconds, the auto pop-out function will not work. In this case, pop out the door handle manually or use the remote transmitter.

If, however, you bring the keyless remote back into range after 10 seconds, the handles will automatically pop out.

Front door outer handles will pop back in 30 seconds after the driver's door is closed or when the transmission is taken out of **P**.

If the vehicle is left for more than 8 days, the auto pop-out function will not work. In this case, unlock the vehicle using the remote transmitter.

If the front door outer handle is popped out and the keyless remote is taken out of the 2 m (6.5 feet) detection range, the handle will pop back in after 30 seconds.

The light flash settings and auto pop-out function can be customized using the audio/information screen.

▶ **How to Customize the Vehicle Settings**

P. 331

■ Using the Remote Transmitter

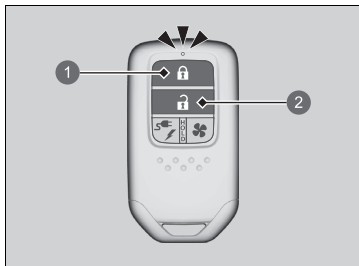

- ① Lock Button
- ② Unlock Button

■ Locking the doors and tailgate

Press the lock button.

- ▶ Some exterior lights flash three times, all the doors and tailgate lock, front door outer handles pop in, and the security system sets.

■ Unlocking the doors and tailgate

Press the unlock button.

- ▶ Some exterior lights flash once, all the doors and tailgate unlock, and front door outer handles pop out.

▣ Using the Remote Transmitter

If you do not open a door or the tailgate within 30 seconds of unlocking the vehicle with the remote transmitter, the doors and tailgate will automatically relock and the front door outer handle will automatically pop back in.

You can change the relock timer setting.

- ▣ **How to Customize the Vehicle Settings**
P. 331

If the front door outer handles were popped in or out while the power mode was set to OFF, they will pop back in or out if the lock/unlock button on the key is pressed.

If the interior light switch is in the door activated position, the interior light comes on when you unlock the doors and tailgate.

No doors opened: The light fades out after 30 seconds.

Doors and tailgate relocked: The light goes off immediately.

- ▣ **Interior Lights** P. 234

You can lock or unlock doors using the remote transmitter only when the power mode is in VEHICLE OFF.

⌘ Using the Remote Transmitter

Right-hand Drive Type

You cannot lock any doors from the outside when the keyless remote is inside the vehicle, and the beeper sounds. If you want to lock a door while the remote is still in the vehicle, do any of the following four times:

- Press the lock button on the keyless remote.
- Touch the door lock sensor on the front door or press the lock button on the tailgate.

The remote transmitter uses low-power signals, so the operating range may vary depending on the surroundings.

If the distance at which the remote transmitter works varies, the battery is probably low.

If the LED does not come on when you press a button, the battery is dead.

➤ Replacing the Button Battery P. 614

The front passenger's door outer handle will pop back in 30 seconds after the driver's door is closed or when the transmission is taken out of **P**.

■ Locking/Unlocking the Doors Using a Key

If the lock/unlock button of the remote does not work, use the key instead.

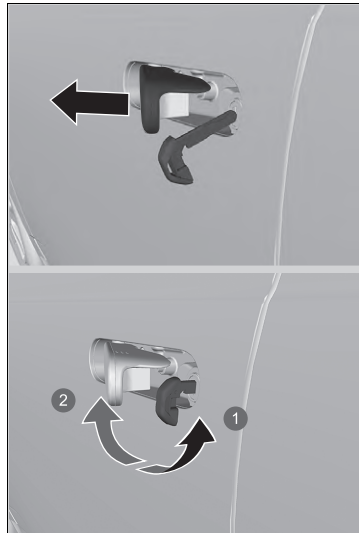

Pull and hold the outer handle. Insert the built-in key into the key cylinder completely from below the handle and then turn it.

- 1 Lock
- 2 Unlock

▣ Locking/Unlocking the Doors Using a Key

When you lock/unlock the driver's door with the key, all the other doors unlock at the same time.

If you unlock a door with the built-in key while the security system is activated, the alarm will go off.

■ Locking a Door Without Using a Key

If you do not have the key on you, or if for some reason you cannot lock a door using the key, you can lock the door without it.

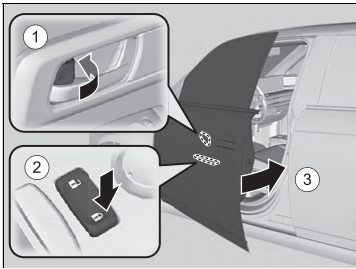

■ Locking the driver's door

Push the lock tab forward ① or push the master door lock switch in the lock direction ②, then pull and hold the outside door handle ③. Close the door, then release the handle.

■ Locking the passenger's doors

Push the lock tab forward and close the door.

■ Lockout prevention system

The doors and the tailgate cannot be locked when the keyless remote is inside the vehicle.

⊠ Locking a Door Without Using a Key

When you lock the driver's door, all the other doors and tailgate lock at the same time.

Before locking a door, make sure that the key is not inside the vehicle.

Locking/Unlocking the Doors from the Inside

■ Using the Lock Tab

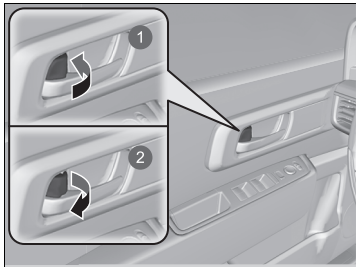

- 1 To Lock
- 2 To Unlock

■ **Locking a door**
Push the lock tab forward.

■ **Unlocking a door**
Pull the lock tab rearward.

■ Unlocking Using the Front Door Inner Handle

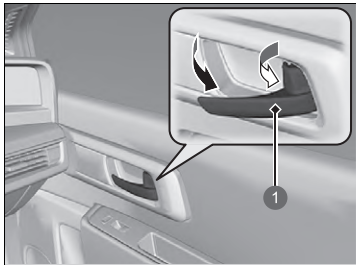

- 1 Inner Handle

Pull the front door inner handle.
► The door unlocks and opens in one motion.

⌘ Using the Lock Tab

When you lock/unlock the door using the lock tab on the driver's door, all the other doors and the tailgate lock/unlock at the same time.

⌘ Unlocking Using the Front Door Inner Handle

The front door inner handles are designed to allow front seat occupants to open the door in one motion. However, this feature requires that front seat occupants never pull a front door inner handle while the vehicle is in motion.

Children should always ride in a rear seat where childproof door locks are provided.

► **Childproof Door Locks** P. 184

When you open any door from inside the vehicle by using the inner handle, front door outer handles pop out.

■ Using the Master Door Lock Switch

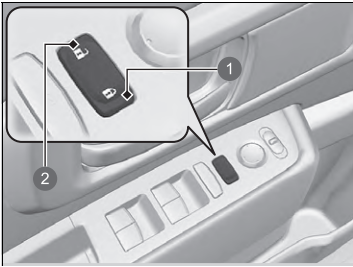

- ① To Lock
- ② To Unlock

Press the master door lock switch in as shown to lock or unlock all the doors and the tailgate.

- ▶ The front door outer handles will also pop in or out when the master door lock switch is pressed.

☒ Using the Master Door Lock Switch

When you lock/unlock either front door using the master door lock switch, all the other doors and the tailgate lock/unlock at the same time.

Childproof Door Locks

The childproof door locks prevent the rear doors from being opened from the inside regardless of the position of the lock tab.

■ Setting the Childproof Door Locks

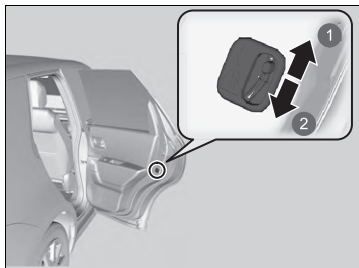

- ① Unlock
- ② Lock

Slide the lever in the rear door to the lock position, and close the door.

■ When opening the door

Open the door using the outside door handle.

☒ Childproof Door Locks

To open the door from the inside when the childproof door lock is on, put the lock tab in the unlock position, lower the rear window, put your hand out of the window, and pull the outside door handle.

NFC Marks

These are needed to use your smartphone as a vehicle key.

If you hold an NFC-compatible device over a mark, you can lock, unlock and start the vehicle without a physical key.

■ Location



For right-hand drive types, NFC marks are located directly opposite to those on left-hand drive types.

The N mark is a registered trademark of NFC Forum, Inc.

☒ NFC Marks

The function may not work in some countries.
Ask a dealer for details.

Precautions for Opening/Closing the Tailgate

Always make sure individuals and objects are clear of the tailgate before opening or closing it.

- Open the tailgate all the way.
 - ▶ If it is not fully opened, the tailgate may begin to close under its own weight.
- Be careful when it is windy. The wind may cause the tailgate to close.

Keep the tailgate closed while driving to:

- ▶ Avoid possible damage.

Precautions for Opening/Closing the Tailgate

WARNING

Anyone caught in the path of a tailgate that is being opened or closed can be seriously injured.

Make sure that all people are clear of the tailgate before opening or closing it.

Be careful not to hit your head on the tailgate or to put your hands between the tailgate and the luggage area when closing the tailgate.

Do not allow any passenger in the luggage space. They may get hurt during hard braking, a sudden acceleration, or a crash.

Opening/Closing the Tailgate

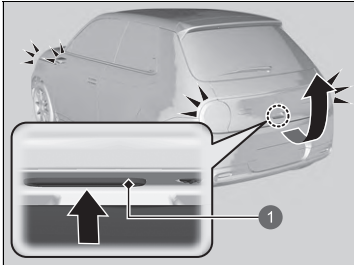

1 Outer Handle

When all the doors are unlocked, the tailgate is unlocked. Press the tailgate outer handle and lift open the tailgate.

If you are carrying the keyless remote, you do not have to unlock the tailgate before opening it.

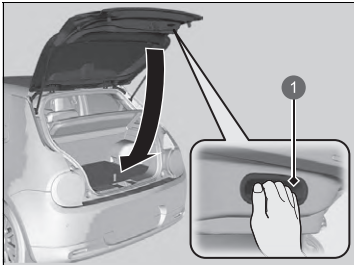

1 Inner Handle

To close the tailgate, grab the inner handle, pull the tailgate down, and push it closed from outside.

Opening/Closing the Tailgate

- Do not leave the keyless remote in the vehicle when you get out. Carry it with you.
- Even if you are not carrying the keyless remote, you can unlock the tailgate while someone else with the remote is within range.

Immobilizer System

The immobilizer system prevents a key that has not been pre-registered from starting the power system. Each key contains electronic transmitters that use electronic signals to verify the key.

Pay attention to the following when pressing the **POWER** button:

- Do not allow objects that emit strong radio waves near the **POWER** button.
- Make sure the key is not covered by or touching a metal object.
- Do not bring a key from another vehicle's immobilizer system near the **POWER** button.

Do not put the key near magnetic items. Electronic device, such as televisions and audio systems emit strong magnetic fields. Note that even a key chain can become magnetic.

Immobilizer System

NOTICE

Leaving the key in the vehicle can result in theft or accidental movement of the vehicle. Always take the key with you whenever you leave the vehicle unattended.

Do not alter the system or add other devices to it. Doing so may damage the system and make your vehicle inoperable.

If the system repeatedly does not recognise the coding of your key, contact a dealer. If you have lost your key and cannot start your vehicle, contact a dealer.

Right-hand Drive Type

Apply and hold the brake pedal before set the power mode to ON the first time after the 12-volt battery has been disconnected.

Security System Alarm

The security system alarm activates when the tailgate, bonnet, or doors are forcibly opened. The alarm does not activate if the tailgate or doors are opened with the remote transmitter or keyless access system.

■ When the security system alarm activates

The horn sounds intermittently and all the exterior lights flash.

■ To deactivate the security system alarm

Unlock the vehicle using the remote transmitter or keyless access system, or turn the power mode to ON. The system, along with the horn and flashing lights, is deactivated.

■ Setting the security system alarm

The security system alarm automatically sets when the following conditions have been met:

- The power mode is set to VEHICLE OFF.
- The bonnet is closed.
- All doors and the tailgate are locked from outside with the remote transmitter or keyless access system.

■ When the security system alarm sets

The security system alarm indicator in the instrument panel blinks and the blinking interval changes after about 15 seconds.

■ To cancel the security system alarm

The security system alarm is cancelled when the vehicle is unlocked using the remote transmitter or keyless access system, or when the power mode is set to ON. The security system alarm indicator goes off at the same time.

☒ Security System Alarm

Do not alter the system or add other devices to it. Doing so may damage the system and make your vehicle inoperable.

The security system alarm will continue for approximately 5 minutes before the security system deactivates.

The system will go through ten 30-second cycles, during which the horn will sound and an emergency indicator will flash.

Depending on circumstances, the security system may continue operating for more than 5 minutes.

Do not set the security system alarm when someone is in the vehicle or a window is open. The system can accidentally activate when:

- Unlocking the door with the lock tab.
- Opening the bonnet with the bonnet release handle.

If the 12-volt battery goes dead after you have set the security system alarm, the security alarm may go off once the 12-volt battery is recharged or replaced. If this occurs, deactivate the security system alarm by unlocking a door using the remote transmitter or keyless access system.

If you unlock a door with the built-in key while the security system is activated, the alarm will go off.

» Security System Alarm

Models with ultrasonic sensors or tilt sensor

The system may accidentally activate such as when:

- The vehicle is parked in an automated garage.
- The vehicle is being washed with highly pressurized water or being put through an automated car wash.
- The vehicle is being transported by train, ferry or trailer.
- The vehicle is subjected to heavy rain or stormy weather.
- Ice is being removed from the vehicle.

You can use ultrasonic sensor **OFF** button and Tilt sensor **OFF** button not to accidentally activate the security system alarm.

➤ **Ultrasonic Sensors*** P. 191

➤ **Tilt Sensor*** P. 192

Ultrasonic Sensors*

The ultrasonic sensors activate only when the security system alarm is set. If the sensors detect an intruder moving around inside or entering the interior of the vehicle through a window, the sensor will activate the alarm.

■ To set the security system alarm without activating the ultrasonic sensors



You can set the security system without activating the ultrasonic sensor.

To turn off the ultrasonic sensor system, set the power mode to VEHICLE OFF by pressing the **POWER** button and then press the ultrasonic sensor **OFF** button.

▶ The  is on in red.

To turn it on again, press the ultrasonic sensor **OFF** button.

Ultrasonic sensors are turned on every time you set the security system alarm, even if you turned it off the last time.

⊗ Ultrasonic Sensors*

Whether the ultrasonic sensors have been activated or not, the security system can only be turned off by the remote transmitter or keyless access system, not the key.

It is possible to confirm whether the vehicle security system was activated without your knowledge. If the security system has been activated, the  will blink for 5 minutes after you unlock the door and disable the system.

If, however, you turn the power system on, the  will stop blinking after 5 seconds.

If the ultrasonic sensor is malfunctioning or there is another problem, the  will come on for 5 minutes after you unlock the door and disable the system.

If, however, you turn the power system on, the  will shut off.

The security system may accidentally activate by ultrasonic sensors such as when:

- Someone is in the vehicle
- A window is open
- Accessories or clothes are hanging in the vehicle

Tilt Sensor*

The tilt sensor activates only when the security system alarm is set. If someone raises the vehicle in an attempt to tow the vehicle or remove the wheels etc., the sensor will activate the alarm.

■ To set the security system alarm without activating the tilt sensor

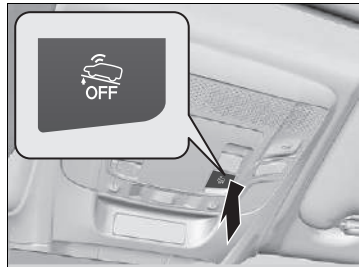

You can set the security system without activating the tilt sensor.

To turn off the tilt sensor system, set the power mode to VEHICLE OFF by pressing the **POWER** button and then press the tilt sensor **OFF** button.

▶ The  is on in red.

To turn it on again, press the tilt sensor **OFF** button.

Tilt sensor is turned on every time you set the security system alarm, even if you turned it off the last time.

⌘ Tilt Sensor*

Whether the tilt sensor has been activated or not, the security system can only be turned off by the remote transmitter or keyless access system, not the key.

It is possible to confirm whether the vehicle security system was activated without your knowledge. If the security system has been activated, the  will blink for 5 minutes after you unlock the door and disable the system.

If, however, you turn the power system on, the  will stop blinking after 5 seconds.

If the tilt sensor is malfunctioning or there is another problem, the  will come on for 5 minutes after you unlock the door and disable the system.

If, however, you turn the power system on, the  will shut off.

Do not set the tilt sensor when the vehicle is lifted or jacked up.

Super Locking*

The super locking function disables the lock tabs on all doors.

■ To activate the super locking function

- Turn the key in the driver's door towards the vehicle front twice within five seconds.
- Press the lock button on the remote transmitter twice within five seconds.
- Touch the door lock sensor on the door handle or press the lock button on the tailgate twice within five seconds.

■ To cancel the super locking function

Unlock the driver's door with the remote transmitter or keyless access system.

▶▶ Super Locking*

⚠ WARNING

No one must be inside the vehicle with the super locking set. Persons locked in can get seriously sick or die from the heat built inside the vehicle if left in the sun.

Make sure there is no one inside the vehicle before setting the super locking.

If you unlock a door with the built-in key while the security system is activated, the alarm will go off.

* Not available on all models

Opening/Closing the Power Windows

The power windows can be opened and closed when the power mode is in ON, using the switches on the doors.

The driver side switches can be used to open and close all the windows. The power window lock button on the driver side must be switched off (not pushed in, indicator off) to open and close the windows from anywhere other than the driver's seat.

When the power window lock button is pushed in, the indicator comes on and you can only operate the driver's window. Turn the power window lock button on if a child is in the vehicle.

Opening/Closing the Power Windows

WARNING

Closing a power window on someone's hands or fingers can cause serious injury.

Make sure your passengers are away from the windows before closing them.

WARNING: Always take the ignition key with you whenever you leave the vehicle alone or with other occupants.

The power windows can be operated for up to 10 minutes after you set the power mode to VEHICLE OFF.

Closing driver's door cancels this function.

When a door is opened, its window will lower slightly to make the door easier to open.

When a window cannot be lowered, such as when the battery has died, it may scrape against the vehicle body. If this happens, slowly open or close the door while pressing down on the upper part of the window.

 **If the 12-Volt Battery Is Dead** P. 647

■ Opening/Closing the Windows with Auto-Open/Close Function

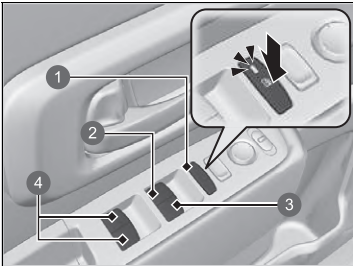

- ① Power Window Lock Button
- ② Driver's Window Switch
- ③ Front Passenger's Window Switch
- ④ Rear Passenger's Window Switch

■ Manual operation

To open: Push the switch down lightly, and hold it until the desired position is reached.

To close: Pull the switch up lightly, and hold it until the desired position is reached.

■ Automatic operation

To open: Push the switch down firmly.

To close: Pull the switch up firmly.

The window opens or closes completely. To stop the window at any time, push or pull the switch briefly.

☒ Opening/Closing the Power Windows

Auto Reverse

If a power window senses resistance when closing automatically, it will stop closing and reverse direction.

The driver's window auto reverse function is disabled when you continuously pull up the switch.

The auto reverse function stops sensing when the window is almost closed to ensure that it fully closes.

■ Opening/Closing the Windows with the Remote

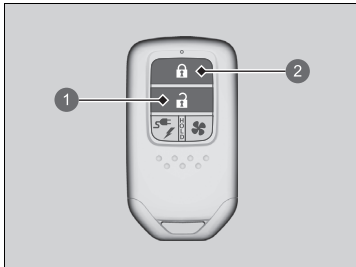

- ① Unlock Button
- ② Lock Button

To open: Press the unlock button, and then within 10 seconds, press it again and hold it.

To close: Press the lock button, and then within 10 seconds, press it again and hold it.

If the windows stop midway, repeat the procedure.

POWER Button

■ Changing the Power Mode

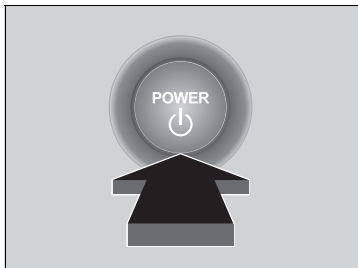

If you carry the keyless remote and press **POWER** button without depressing the brake pedal, the power mode will change in this order: VEHICLE OFF→ACCESSORY→ON→VEHICLE OFF.

VEHICLE OFF:

Vehicle power is turned OFF.

ACCESSORY:

The audio system and some accessories can be used.

ON

All accessories can be used.

☒ POWER Button

If the keyless remote is set in a storage box or another place where its signal can be interrupted, the power mode may not change.

■ Auto Power ON/OFF

This function allows you to automatically change the power mode ON or VEHICLE OFF when entering or exiting the vehicle without using the **POWER** button.

When entering the vehicle:

The power mode will change to ON when you enter the vehicle while carrying the keyless remote and close the driver's door.

- ▶ After this, if you depress the brake pedal, the power system will turn on and the  (ready) indicator will turn on.

🔗 **Starting to Drive** P. 381

When exiting the vehicle:

The power mode will change to VEHICLE OFF when you exit the vehicle while carrying the keyless remote and close the door.

- ▶ If you leave the vehicle, lock the doors.

🔗 **Locking/Unlocking the Doors from the Outside** P. 175

🔗 Auto Power ON/OFF

WARNING

The Automatic Power ON/OFF function can shut-off the vehicle's climate control system even if you intend for it to remain on after leaving the vehicle. If the vehicle is exposed to temperature extremes and the climate control system shuts off, the vehicle interior may become dangerously hot or cold, creating a risk of injury or death for any child, person needing assistance, or animal left inside. Do not leave children, persons needing assistance, or animals unattended in the vehicle.

The power mode will not change to ON when entering the vehicle in the following situations:

- The bonnet is open.
- The power mode was turned to VEHICLE OFF with the **POWER** button the last time the vehicle was exited.

The power mode will not change to VEHICLE OFF when exiting the vehicle in the following situations.

- The transmission is in a position other than **[P]**.
- The driver's seat belt is fastened.
- "Yes" was chosen during Auto Power OFF guidance.
- The keyless remote is inside the vehicle.

If any of the doors or the tailgate is opened while the power mode is in ON, a beep will sound the vehicle and Auto Power OFF guidance will display on the screen. If you select "YES" the power mode will not change to VEHICLE OFF even if you exit the vehicle with the key.

▶ Since Auto Power OFF (including battery power preservation) is not enabled, make sure to press the power switch when exiting the vehicle.

If you select "NO" or do not select either option, Auto Power OFF will activate when you exit the vehicle with the key and close the door.

■ Automatic Power Off

If you leave the vehicle for 30 to 60 minutes with the transmission in **P** and the power mode in ACCESSORY, the vehicle automatically goes into the mode similar to VEHICLE OFF (LOCK) to avoid draining the 12-volt battery.

■ Power Mode Reminder

If you open the driver's door when the power mode is set to ACCESSORY, a warning beep sounds.

⌘ Auto Power ON/OFF

If none of the above situations apply but the power mode still does not change, refer to the following.

➤ **Low Keyless Remote Signal Strength** P. 174

If the vehicle is not operated while the shift position is in **P** and the driver's seat belt is not fastened, the power mode will change to VEHICLE OFF after some time.

You can change the Auto Power ON/OFF settings.

➤ **How to Customize the Vehicle Settings**
P. 331

If the vehicle is stopped for a period of time while the power mode is in ON, a beep will sound and guidance for preserving battery power will display on the screen.

If you select "YES" the power mode will stay ON.

If you select "NO" or do not select either option, the power mode will automatically change to VEHICLE OFF after 10 or more seconds.

■ Keyless Remote Reminder

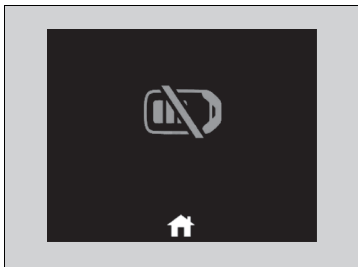

When the power mode is set to any mode other than OFF and you remove the keyless remote from the vehicle and shut the door, an alarm will sound. If the alarm continues to sound, place the keyless remote in another location.

■ When the power mode is in ACCESSORY

The alarm will sound from outside the vehicle.

■ When the power mode is in ON

An alarm will sound both inside and outside the vehicle. In addition, a warning indicator will appear on the instrument panel.

■ Auto Power ON/OFF

If you try to depress the brake pedal and move the vehicle without the keyless remote, the driver information interface will display a warning message and an alarm will sound from inside and/or outside the vehicle. Check if the keyless remote is in the vehicle.

⊠ Keyless Remote Reminder

When the keyless remote is within the system's operational range, and the driver's door is closed, the warning function cancels.

If the keyless remote is taken out of the vehicle after the power system has been turned on, you can no longer change the **POWER** button mode or restart the power system. Always make sure if the remote is in your vehicle when you operate the **POWER** button.

Removing the keyless remote from the vehicle through a window does not activate the warning buzzer.

Do not put the keyless remote on the dashboard or in the glove box. It may cause the warning buzzer to go off. Under some other conditions that can prevent the vehicle from locating the remote, the warning buzzer may also go off even if the remote is within the system's operational range.

Lights

■ Headlights/Position Lights

The lights will turn on automatically depending on the ambient brightness. They can also be switched on and off manually.

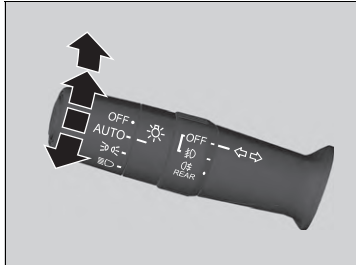

The exterior lights will switch on automatically when the light switch is set to **AUTO** while the power mode is in ON.

■ Manual operation

Headlights/position lights:

Turn the light switch to .

Position lights:

Turn the light switch to .

Headlight/position lights off:

Turn the light switch to **OFF** and release it while the shift position is in **P** and the parking brake is applied.

▶ The lights will come back on automatically when:

- The light switch is turned to **OFF** again and released.
- The shift position is changed out of **P** and the parking brake is released.



⌘ Lights

When the lights are on, the lights on indicator in the instrument panel will be on.

➤ **Lights On Indicator** P. 120

⌘ Headlights/Position Lights

When the position lights are on, the tail and rear licence plate lights will also switch on.

When the light switch is turned to  or  and the power is turned to OFF, a beeper sounds when the driver's door is opened.

When the light switch is turned to **AUTO** and the ambient light levels are low, the headlights and position lights will switch on if you unlock a door. They will switch off when the door is locked.

The light sensor is in the location shown below. Do not cover the light sensor.

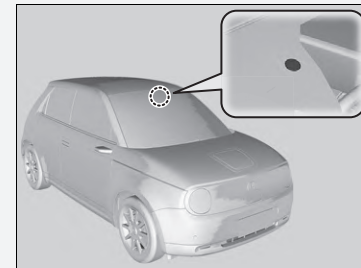

■ High Beams

When the headlights are on, push the lever forward. Pull the lever back to return to low beams.

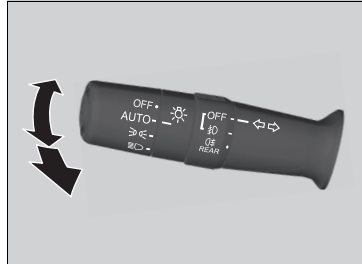

■ **Flashing the high beams**
Pull the lever back to switch on the high beams.

▶ Release the lever to return to low beams.

■ Turn Signals

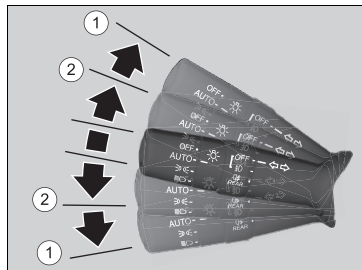

The turn signals can be used when the power mode is in ON.

■ **①: Turn signal**
Push the lever up or down based on the direction you want to turn, and the turn signal will blink.

■ **②: One-touch turn signal**
When you lightly push the lever up or down and release it, the turn signal will blink 3 times.
▶ If you lightly push the lever in the opposite direction while it is blinking, the blinking will stop.

⊠ Headlights/Position Lights

Your vehicle is equipped with the automatic headlight adjusting system that automatically adjusts the vertical angle of the low beam headlights. If you find a significant change in the vertical angle of the headlights, there may be a problem with the system. Have your vehicle checked by a dealer.

The position lights and the door outer handle ambient lights and charge lamp will light up in the following situations. It will turn off shortly.

- The keyless remote is brought close to the vehicle
- The driver's door is unlocked
- Any door is opened
- The power mode is turned to OFF

However, if the door of the vehicle is locked for over a week, even if the keyless remote is brought close to the vehicle, they will not light up.

⊠ Turn Signals

The turn signal indicator on the instrument panel will blink when the external turn signal blinks.

▶ **Indicators** P. 106

■ Headlight Integration with Wipers

The headlights automatically come on when the wipers are used several times within a certain number of intervals with the headlight switch in **AUTO**.

The headlights automatically go off a few minutes later if the wipers are stopped.

■ Automatic Lighting Off Feature

The headlights, all other exterior lights, and the instrument panel lights turn off 15 seconds after you set the power mode to VEHICLE OFF (LOCK), take the remote with you, and close the driver's door.

However, when the switch is in , the position lights remain on.

If you set the power mode to VEHICLE OFF with the headlight switch on, but do not open the door, the lights turn off after 10 minutes (3 minutes, if the switch is in the **AUTO** position).

The lights turn on again when you unlock or open the driver's door. If you unlock the door, but do not open it within 15 seconds, the lights go off. If you open the driver's door, you will hear a lights on reminder chime.

⌘ Headlight Integration with Wipers

This feature activates while the headlights are off in **AUTO**. The instrument panel brightness does not change when the headlights come on.

At dark ambient light levels, the automatic lighting control feature turns on the headlights, regardless of the number of wiper sweeps.

You can turn the headlight integration with wipers function on and off.

➤ **How to Customize the Vehicle Settings**
P. 331

⌘ Automatic Lighting Off Feature

You can change the headlight auto off timer setting.

➤ **How to Customize the Vehicle Settings**
P. 331

■ Fog Lights

The fog lights can be used when the power mode is in ON.

■ Front fog lights

Can be used when the position lights or the headlights are on.

■ Rear fog light

Can be used when the headlights or the front fog lights are on.

■ Front and rear fog light switch

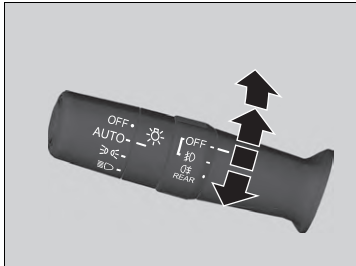

To turn the front fog lights on:

Rotate the switch up from the **OFF** position to the **FO** position. The **FO** indicator comes on.

To turn the front and rear fog lights on:

Rotate the switch one position up from the **FO** position. The **FO** and **REAR** indicators come on.

To turn the rear fog lights on:

Rotate the switch one position up from the **FO** position and then rotate the switch one position down from the **FO** position. The **REAR** indicator stays on.

To turn the rear fog light off, turn the headlight switch to the **OFF** position.

■ Daytime Running Lights

The daytime running lights come on when the following conditions have been met:

- The power mode is in ON.
- The headlight switch is **AUTO**.
- The ambient light is bright.

While the vehicle is stopped, if you turn the light switch to **OFF** and release it, the daytime running lights will turn off. When the shift position is changed out of **P** and the parking brake is released, the lights will come on again. Otherwise, if the light switch is once more turned to **OFF**, the lights will come on again.

☒ Daytime Running Lights

Daytime running lights and the position lights share the same light source.

Daytime running lights are brighter than the position lights.

The daytime running lights will not switch on if the position lights have been turned on manually.

Auto High-Beam

The front sensor camera detects the light sources ahead of the vehicle such as the lights of a preceding or oncoming vehicle, or street lights. When you are driving at night, the system automatically switches the headlights between low beam and high beam depending on the situation.

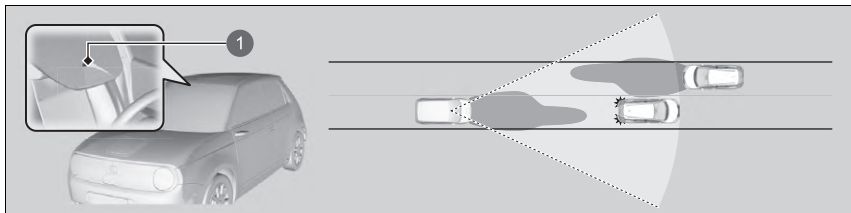

1 Front Sensor Camera

How to Use the Auto High-Beam

When all of the following conditions have been met, the auto high-beam indicator comes on and the auto high-beam is activated.

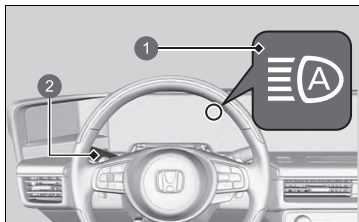

1 Auto High-Beam Indicator

2 Light Switch

- The power mode is in ON.
- The light switch is in **AUTO**.
- The lever is in the low beam position.
- The headlights have been automatically activated.
- It is dark outside the vehicle.

Auto High-Beam

The auto high-beam system does not always operate in every situation. This system is just for assisting the driver. Always observe your surroundings and switch the headlights between high beam and low beam manually if necessary.

The range and the distance at which the camera can recognise varies depending on conditions surrounding your vehicle.

Regarding the handling of the camera mounted to the inside of the windscreen, refer to the following.

Front Sensor Camera P. 492

For the auto high-beam to work properly:

- Do not place an object that reflects light on the dashboard.
- Keep the windscreen around the camera clean. When cleaning the windscreen, be careful not to apply windscreen cleanser to the camera lens.
- Do not attach an object, sticker or film to the area around the camera.
- Do not touch the camera lens.

If the camera receives a strong impact, or repairing of the area near the camera is required, consult a dealer.

If the auto high-beam indicator does not come on even when all the conditions have been met, carry out either of the procedures below and the indicator will come on.

- Pull the lever towards you and hold it over two seconds then release it.
- Turn the light switch to  then turn the light switch to **AUTO**.

■ Automatic switching between high-beam and low-beam

When auto high-beam is active, the headlights switch between high beam and low beam based on the following conditions.

Switching to high beam:

All of the following conditions must be met before the high beams turn on.

- Your vehicle speed is 40 km/h (25 mph) or more.
- There are no preceding or oncoming vehicle with headlights or taillights turned on.
- There are few street lights on the road ahead.



Switching to low beam:

One of the following conditions must be met before the low beams turn on.

- Your vehicle speed is 24 km/h (15 mph) or less.
- There is a preceding or oncoming vehicle with headlights or taillights turned on.
- There are many street lights on the road ahead.

⌘ Automatic switching between high-beam and low-beam

In the following cases, the auto high-beam system may not switch the headlights properly or the switching timing may be changed. In case of the automatic switching operation does not fit for your driving habits, please switch the headlights manually.

- The brightness of the lights from the preceding or oncoming vehicle is intense or poor.
- Visibility is poor due to the weather (rain, snow, fog, windscreen frost, etc.).
- Surrounding light sources, such as street lights, electric billboards and traffic lights are illuminating the road ahead.
- The brightness level of the road ahead constantly changes.
- The road is bumpy or has many curves.
- A vehicle suddenly appears in front of you, or a vehicle in front of you is not in the preceding or oncoming direction.
- Your vehicle is tilted with a heavy load in the rear.
- A traffic sign, mirror, or other reflective object ahead is reflecting strong light towards the vehicle.
- The oncoming vehicle frequently disappears under roadside trees or behind median barriers.
- The preceding or oncoming vehicle is a motorcycle, bicycle, mobility scooter, or other small vehicle.

The auto high-beam system keeps the headlight low beam when:

- Windscreen wipers are operating at a high speed.
- The camera has been detected a dense fog.

■ Manual switching between high-beam and low-beam

If you want to manually switch the headlights between high beam and low beam, follow either of the procedures below. Note that when you do this, the auto high-beam indicator will turn off and the auto high-beam will be deactivated.

Using the lever:

Pull the lever towards you for flashing the high beams then release it or push the lever forward to the high beam position.

- ▶ To reactivate the auto high-beam, follow either of the procedures below and the auto high-beam indicator will come on.
- Pull the lever towards you and hold it over two seconds then release it.
- Turn the light switch to  and then to **AUTO** when the lever is in the low beam position.

Using the light switch:

Turn the light switch to .

- ▶ To reactivate the auto high-beam, turn the light switch to **AUTO** when the lever is in the low beam position, the auto high-beam indicator will come on.

■ How to Turn Off the Auto High-Beam

You can turn the auto high-beam system off. If you want to turn the system off or on, set the power mode to ON, then carry out the following procedures while the vehicle is stationary.

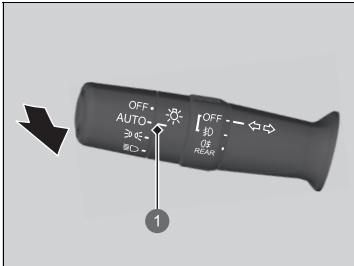

① **AUTO** Position

To turn the system off:

With the light switch is in **AUTO**, pull the lever towards you and hold it for at least 40 seconds. After the auto high-beam indicator light blinks twice, release the lever.

To turn the system on:

With the light switch is in **AUTO**, pull the lever towards you and hold it for at least 30 seconds. After the auto high-beam indicator light blinks once, release the lever.

☒ How to Turn Off the Auto High-Beam

If you turn the auto high-beam system off, the system does not operate until you turn the system on.

Park in a safe place before turning the system off or on.

Wipers and Washers

■ Windscreen Wipers/Washers

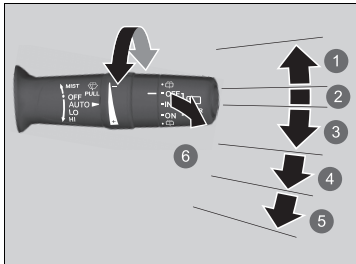

- 1 **MIST**
- 2 **OFF**
- 3 **AUTO**
- 4 **LO**: Low speed wipe
- 5 **HI**: High speed wipe
- 6 **Washer**

The windscreen wipers and washers can be used when the power mode is in ON.

■ MIST

The wipers run at high speed until you release the lever.

■ Wiper switch (OFF, AUTO, LO, HI)

Move the lever up or down to change the wiper settings.

■ Washer

Sprays while you pull the lever towards you. When you release the lever for more than one second, the spray stops, the wipers sweep two or three more times to clear the windscreen, then stop.

» Wipers and Washers

NOTICE

Do not use the wipers when the windscreen is dry. The windscreen will get scratched, or the rubber blades will get damaged.

NOTICE

Turn the washers off if no washer fluid comes out. The pump may get damaged.

The wiper motor may stop motor operation temporarily to prevent an overload. Wiper operation will return to normal within a few minutes, once the circuit has returned to normal.

NOTICE

In cold weather, the blades may freeze to the windscreen.

Operating the wipers in this condition may damage the wipers. Use the demister to warm the windscreen, then turn the wipers on.

If the wipers stop operating due to an obstacle such as the build-up of snow, park the vehicle in a safe place. Rotate the wiper switch to **OFF**, and set the power mode to ACCESSORY or VEHICLE OFF, then remove the obstacle.

Automatic Intermittent Wipers

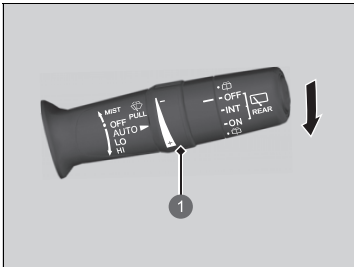

1 Adjustment Ring

When you push the lever down to **AUTO**, the windscreen wipers sweep once, and go into the automatic mode.

The wipers operate intermittently, at low speed, or at high speed and stops in accordance with the amount of rainfall the rainfall sensor detects.

■ AUTO sensitivity adjustment

When the wiper function is set to **AUTO**, you can adjust the sensitivity of the rainfall sensor (using the adjustment ring) so that wipers will operate in accordance with your preference.

Sensor sensitivity

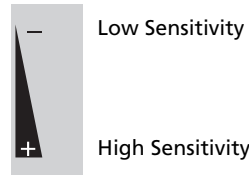

Automatic Intermittent Wipers

The rainfall sensor is in the location shown below.

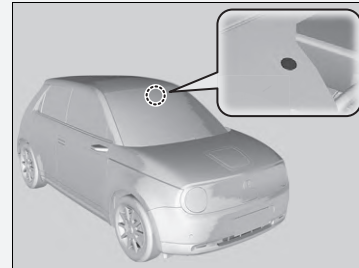

NOTICE

AUTO should always be turned **OFF** before the following situations in order to prevent severe damage to the wiper system:

- Cleaning the windscreen
- Driving through a car wash
- No rain present

■ Rear Wiper/Washer

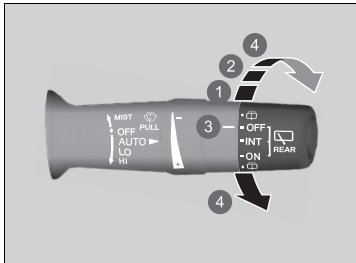

- 1 INT (Intermittent)
- 2 ON (Continuous wipe)
- 3 OFF
- 4 Washer

The rear wiper and washer can be used when the power mode is in ON.

■ Wiper switch (OFF, INT, ON)

Change the wiper switch setting according to the amount of rain.

■ Washer (☼)

Sprays while you rotate the switch to this position.

Hold it to activate the rear wiper and to spray the washer. Once released, the washer spray will stop and the rear wiper will return to its selected switch setting after a few sweeps.

■ Operating in reverse

When you shift the transmission to **R** with the windscreen wipers activated, the rear wiper operates automatically as follows even if its switch is off.

Front Wiper Position	Rear Wiper Operation
AUTO (Intermittent)	Intermittent
LO (Low speed wipe) HI (High speed wipe)	Continuous

Rear Demister Button

Press the rear demister button to demist the rear window when the power mode is in ON.

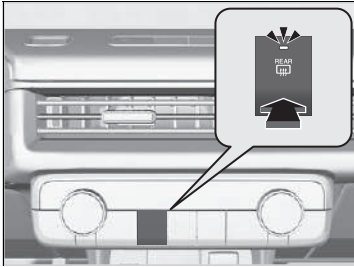

The rear demister automatically switches off after 10-30 minutes depending on the outside temperature. However, if the outside temperature is 0°C or below, it does not automatically switch off.

⌘ Rear Demister Button

This system consumes a lot of power, so turn it off when the window has been demisted. Also, do not use the system for a long time while the power system is stopped. This may weaken the 12-volt battery, making it difficult to turn the power system on.

Adjusting the Steering Wheel

The steering wheel height and distance from your body can be adjusted so that you can comfortably grip the steering wheel in an appropriate driving posture.

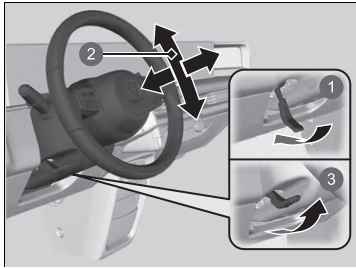

- 1 Release
- 2 Adjust
- 3 Lock

1. Push the steering wheel adjustment lever down.
 - ▶ The steering wheel adjustment lever is lower left side of the steering column.
2. Move the steering wheel up or down, and in or out.
 - ▶ Make sure you can see the instrument panel gauges and indicators.
3. Pull the steering wheel adjustment lever up to lock the steering wheel in position.
 - ▶ After adjusting the position, make sure you have securely locked the steering wheel in place by trying to move it up, down, in, and out.

Adjusting the Steering Wheel

WARNING

Adjusting the steering wheel position while driving may cause you to lose control of the vehicle and be seriously injured in a crash.

Adjust the steering wheel only when the vehicle is stopped.

Adjustment of Each Type of Mirror

Adjust each mirror before driving so you can check the rear in the correct driving position.

Centre Camera Mirror System

By displaying video on the rearview mirror from a camera in the rear of the vehicle, it is possible to check your rear view without blocking by the headrest or passengers. It can also be used as a mirror without the video display by moving the lever position.

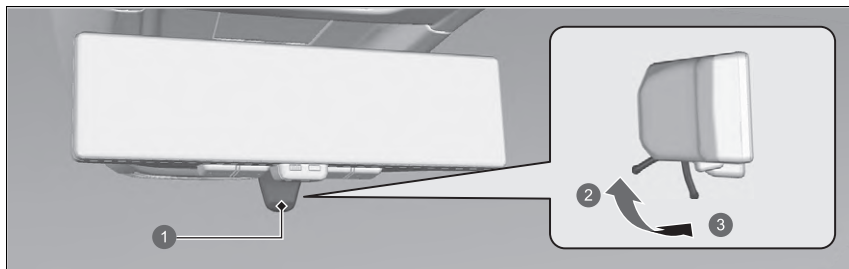

- ① Lever
- ② Mirror mode
- ③ Monitor mode

If you move the lever to the monitor mode position while the power mode is in ON, video will be displayed. When you move the lever, the direction of the mirror will change, so adjustments to the position of the mirror should be made in mirror mode.

Centre Camera Mirror System

When driving, visually check for other vehicles and confirm the safety of your surroundings.

Depending on ambient conditions, the following may appear on the image.

- The area around bright objects like the sun or the headlights of following vehicles blurs white.
- The image flickers due to ambient light.

Depending on conditions, it may take some time for your eyes to focus on the image. Make sure you can see it clearly before use.

Monitor mode and mirror mode appear differently. If it is hard to see the image in monitor mode, use mirror mode instead.

Using the monitor mode for a long time may cause the rearview mirror to get hot.

This icon  displays in monitor mode.

Centre Camera Mirror System

The camera is located inside the rear glass.

Camera position

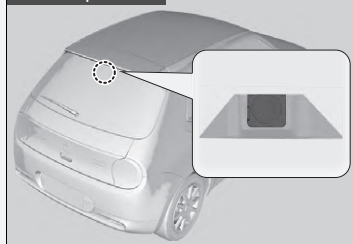

Do not cover the rear glass with a film or stickers where they can block the field of view of the camera.

If a camera unit receives a strong impact or repairing of the area near the camera is required, consult a dealer.

If there are foreign objects or dirt around the camera, have your vehicle checked by a dealer.
If the mirror becomes dirty, use a soft cloth to keep it clean.

■ Adjusting the Brightness and Field of View

1. Change to monitor mode
2. Use the menu button to select the setting
3. Change the setting via button 1 or 2

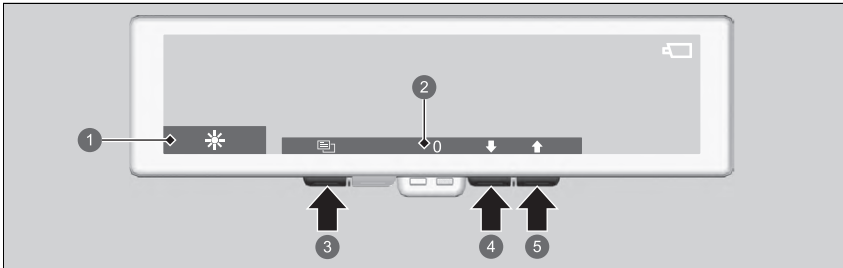

- 1 Icon
- 2 Setting Value
- 3 Menu Button
- 4 Button 1
- 5 Button 2

▣ Adjusting the Brightness and Field of View

Adjust settings before driving.

When you adjust the settings of field of view too much, the image may appear skewed.

If the ambient lighting is high, the brightness of the image may not change when you adjust setting of the brightness.

When the automatic brightness setting is turned ON, the brightness of the image will be automatically adjusted based on ambient lighting. In order to keep the sensor working correctly, do not touch or cover it.

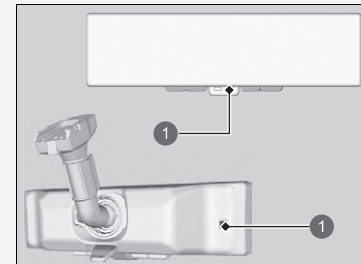

- 1 Sensor

If the ambient lighting becomes low, the image will also darken even if automatic brightness settings are set to OFF.

Setting	Icon	Button 1	Button 2
Brightness	☀	Low ↓	High ↑
Automatic brightness (On/Off)	☀ _{AUTO}	Off OFF	On ON
Field of view (up/down)	↕	Down ↓	Up ↑
Field of view (left/right)	↔	Left ←	Right →
Field of view (rotation)	↻	Counter-clockwise ↻	Clockwise ↻

■ Indicators

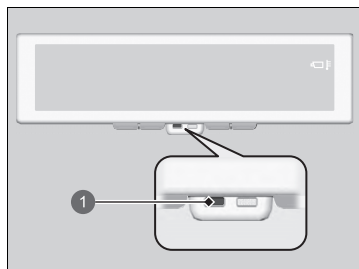

① Indicator

When the indicator turns on, quickly change to mirror mode.

If the mirror becomes too hot or cold, this icon  will display on the image in addition to the indicator.

If only the indicator continues to stay on, it is most likely a system problem so have your vehicle checked by a dealer.

☒ Indicators

If the mirror becomes hot, the image may darken, and if it becomes too hot the image may no longer display. If the mirror becomes cold, there may be after-images on the display, and if it becomes too cold the image may no longer display.

When the indicator is on, the image may stop automatically adjusting brightness or may no longer display.

■ PLS Mode

If you press and hold the PLS button while in monitor mode, the image will darken and glare from bright objects like the headlights of following vehicles will be minimized. It will return to normal brightness if you press the PLS button again.



① PLS Button

☒ PLS Mode

This icon  will display on top of the image in PLS mode.

Side Camera Mirror System

Using cameras mounted on the left and right sides of the vehicle, video of the rear view of the vehicle will be displayed on in-vehicle displays. The displays will turn on when one of the front doors is opened or the power mode is set to ON.

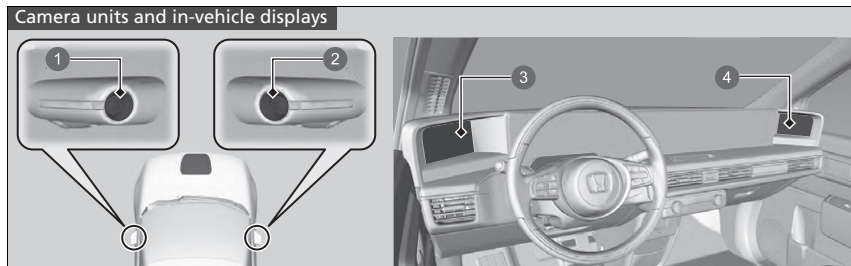

- ① Left Camera Lens
- ② Right Camera Lens
- ③ Left Screen
- ④ Right Screen

Side Camera Mirror System

When driving, visually check for other vehicles and confirm the safety of your surroundings. Depending on ambient conditions, the following may appear on the image.

- The area around bright objects like the sun or the headlights of following vehicle blurs white.
- The image flickers due to ambient light conditions.
- The left and right side of the image differ in brightness or colour due to ambient light conditions or reflected objects.

Depending on conditions, it may take some time for your eyes focus on the display. Make sure you can see it clearly before use.

The screens will turn off in the following situations:

- The security system alarm is set via locking mechanism.
- Nothing had been operated for two minutes while the power mode is not in ON.

The screens' brightness will gradually be adjusted darker automatically as ambient light decreases. You can adjust the brightness of the screens when the ambient light is low. The screens can also be adjusted in high ambient light, but the screens' brightness will not change.

▶ **Changing the Screen Brightness** P. 277

■ Adjusting the Field of View

When the power mode is in ON, you can adjust the display's field of view.

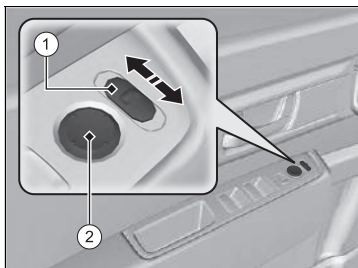

■ ①: L/R selector switch

Choose which field of view to adjust by moving the switch left or right. Return the switch to the centre position after adjustment.

■ ②: Adjustment switch

This is the switch for adjusting the field of view vertically and horizontally. When adjusting the field of view,  will appear on the image.

■ Resetting the field of view

When the L/R selector switch ① is set to the centre, hold the adjustment switch ② to up or to left for about five seconds to reset the field of view to factory settings.

⌘ Side Camera Mirror System

If a camera unit receives a strong impact or repairing of the area near the camera is required, consult a dealer.

If a camera lens is covered with dirt or moisture, use a soft cloth moist with water or neutral detergent to clean it. Do not use wax or water repellent agent on the camera lens.

If a screen becomes dirty, use a soft cloth to keep it clean.

NOTICE

Do not apply hot water to camera units in cold weather. The camera lens may fog up or crack due to extreme changes in temperature.

⌘ Adjusting the Field of View

Adjust the field of view before driving.

You can change between normal view and wide view. The field of view will become wider when wide view is chosen.

➤ How to Customize the Vehicle Settings

P. 331

When in wide view, you can choose between two horizontal fields of view. In wide view, you cannot move the switch vertically and  will display on the screen.

Adjusting the Field of View



To ensure a better view while reversing, when the shift position is changed to **[R]** the display will change to reverse view and the field of view will be lower.

You can adjust the field of view for the normal, wide, and reverse views.

You cannot reset the field of view for the reverse view.

Compared to normal view, the wide and reverse view display areas are wider, and people, objects, and vehicles may appear a different size from what they are. Check how the video looks before use.

The following icons will display on the image in their respective mode:

- : Normal view
- : Wide view
- : Reverse view

Reference Lines

Forward display

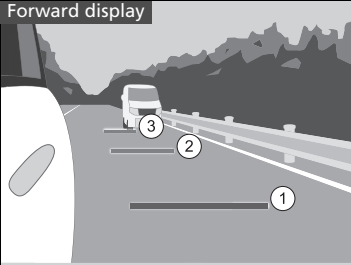

■ Display when moving forward

When the power mode is in ON, press the side camera switch and the forward reference lines will display for several seconds. Press the switch once more while the display is on to turn it off.

The three lines indicate the following:

- ①: About 3 m (10 feet) from rear bumper
- ②: About 10 m (33 feet) from rear bumper
- ③: About 20 m (66 feet) from rear bumper

Side camera switch

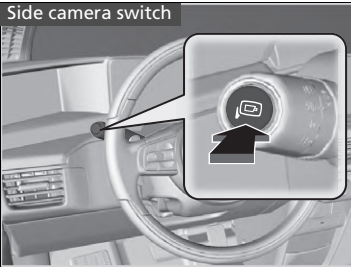

☒ Reference Lines

The positioning of the reference lines may differ from the true distance due to vehicle height or road conditions. Please use them only as guidelines. Visually check your surroundings when changing lanes or reversing.

☒ Display when moving forward

You can change the forward reference lines so they display together with the turn signals.

☒ **How to Customize the Vehicle Settings**

P. 331

If you press the side camera switch while the display is off, the displays will turn on but there will be no reference lines.

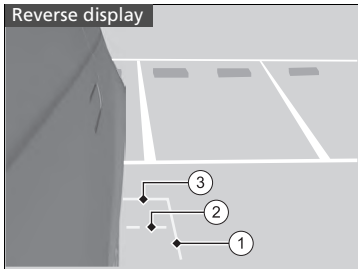

■ Display when reversing

When the shift position is set to **R**, the reverse reference lines will display.

The three lines indicate the following:

- ①: About 25 cm (10 inches) from the side of the vehicle
- ②: Position where tailgate can be opened or closed
- ③: About 1 m (39 inches) from rear bumper

» Display when reversing

You can change the reverse reference line display settings.

» How to Customize the Vehicle Settings

P. 331

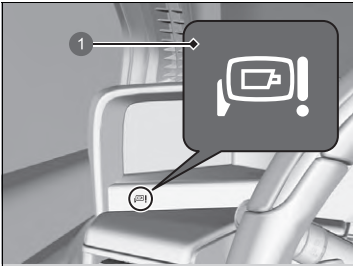

Indicator



1 Indicator

When the temperature is too extreme or there is a problem with the system, the indicator will come on.

When the temperature inside the vehicle is too hot or too cold:

This icon  will be displayed on the image. The  indicator will also be displayed on the instrument panel. When the temperature inside the vehicle returns to a temperature at which the system can operate the  indicator will turn off.

When there is a system problem:

The video will no longer display. This indicator  will also be displayed on the instrument panel. Have the side camera mirror system promptly repaired by a dealer.

Indicator

If the temperature inside the vehicle is high, the image may darken, and if the temperature becomes too high, the image may not show. If the temperature inside the vehicle is low, there may be afterimages on the display.

If the temperature in the vehicle is too hot or cold, you can use the climate control system to regulate the temperature.

Front Seats

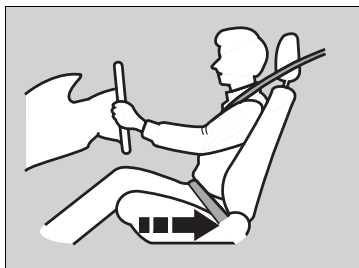

Move back to allow sufficient space.

Adjust the driver's seat as far back as possible while allowing you to maintain full control of the vehicle. You should be able to sit upright, well back in the seat and be able to adequately press the pedals without leaning forward, and grip the steering wheel comfortably. The passenger's seat should be adjusted in a similar manner, so that it is as far back from the front airbag in the dashboard as possible.

Seats

⚠ WARNING

Sitting too close to a front airbag can result in serious injury or death if the front airbags inflate.

Always sit as far back from the front airbags as possible while maintaining control of the vehicle.

In addition to the seat adjustment, you can adjust the steering wheel up and down, in and out. Allow at least 25 cm (10 inches) between the centre of the steering wheel and the chest.

Always make seat adjustments before driving.

■ Adjusting the Seat Positions

■ Adjusting the front manual seat

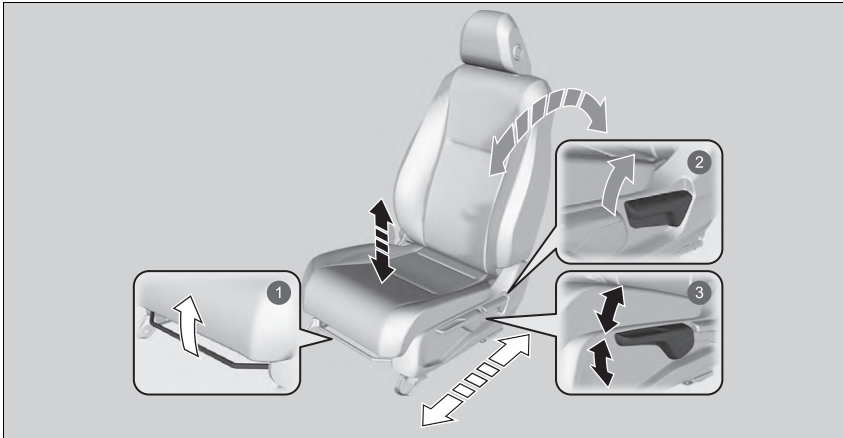

1 Horizontal Position Adjustment

Pull up on the bar to move the seat, then release the bar.

2 Seat-back Angle Adjustment

Pull up the lever to change the angle.

3 Height Adjustment (Driver side only)

Pull up or push down the lever to raise or lower the seat.

▣ Adjusting the front manual seat

Once a seat is adjusted correctly, rock it back and forth to make sure it is locked in position.

■ Adjusting the Seat-Backs

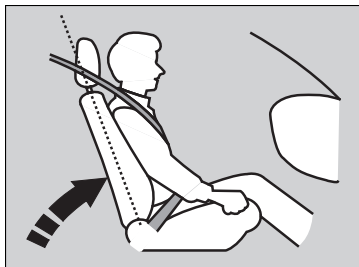

Adjust the driver's seat-back to a comfortable, upright position, leaving ample space between your chest and the airbag cover in the centre of the steering wheel.

The front seat passenger should also adjust their seat-back to a comfortable, upright position.

Reclining a seat-back so that the shoulder part of the belt no longer rests against the occupant's chest reduces the protective capability of the belt. It also increases the chance of sliding under the belt in a crash and being seriously injured. The farther a seat-back is reclined, the greater the risk of injury.

► Adjusting the Seat-Backs

⚠ WARNING

Reclining the seat-back too far can result in serious injury or death in a crash.

Adjust the seat-back to an upright position, and sit well back in the seat.

Do not put a cushion, or other object, between the seat-back and your back.

Doing so may interfere with proper seat belt or airbag operation.

If you cannot get far enough away from the steering wheel and still reach the controls, we recommend that you investigate whether some type of adaptive equipment may help.

Rear Seats

Folding Down the Rear Seats

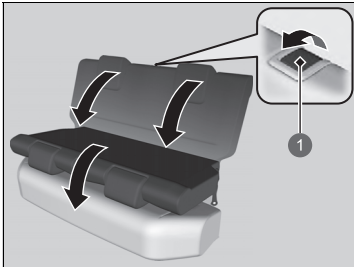

① Release Lever

1. Lower the rear seat head restraint to its lowest position.
2. Pull the release lever and fold down the seat.

Rear Seat Reminder

This feature alerts you to passengers or items possibly forgotten in the rear seat. It activates when the rear doors are opened, and will alert you by display and sound before exiting the vehicle.



Folding Down the Rear Seats

⚠ WARNING

Make sure the seat-backs are latched securely before driving.

The rear seat-backs can be folded down to accommodate bulkier items in the luggage area.

When returning the seat-back to its original position, push it firmly back. Also, make sure all rear shoulder belts are positioned in front of the seat-back.

Make sure all items in the luggage area or items extending through the opening into the rear seats are properly secured. Loose items can fly forward if you have to brake hard.

Rear Seat Reminder

When the power mode is set to OFF, the reminder will go off and the function will terminate.

The reminder will also go off when the shift position is set to **P** and the driver's seat belt is unfastened before setting the power mode to OFF.

The reminder will not work if the power mode has not been set to ON within 10 minutes of operating the rear doors.

Maintain a Proper Sitting Position

After all occupants have adjusted their seats and head restraints, and put on their seat belts, it is very important that they continue to sit upright, well back in their seats, with their feet on the floor, until the vehicle is safely parked and the power mode is off.

Sitting improperly can increase the chance of injury during a crash. For example, if an occupant slouches, lies down, turns sideways, sits forward, leans forward or sideways, or puts one or both feet up, the chance of injury during a crash is greatly increased.

In addition, an occupant who is out of position in the front seat can be seriously or fatally injured in a crash by striking interior parts of the vehicle or being struck by an inflating front airbag.

►► Rear Seat Reminder

The system does not detect passengers in the rear seat(s). Instead, it can detect when a rear door is opened and closed, indicating that there may be something in the rear seat(s).

You can turn off the notification setting.

► **How to Customize the Vehicle Settings** P. 331

►► Maintain a Proper Sitting Position

WARNING

Sitting improperly or out of position can result in serious injury or death in a crash.

Always sit upright, well back in the seat, with your feet on the floor.

Head Restraints

Your vehicle is equipped with head restraints in all seating positions.

■ Adjusting the Front Head Restraint Positions

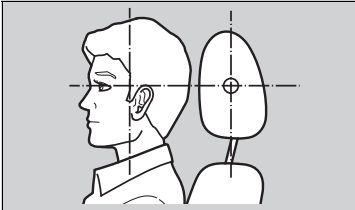

Position head in the centre of the head restraint.

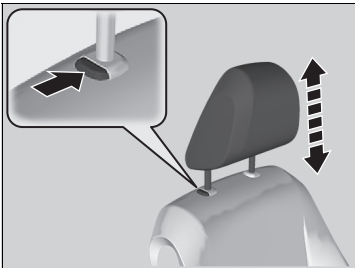

Head restraints are most effective for protection against whiplash and other rear-impact crash injuries when the centre of the back of the occupant's head rests against the centre of the restraint. The tops of the occupant's ears should be level with the centre height of the restraint.

To raise the head restraint: Pull it upward.

To lower the head restraint: Push it down while pressing the release button.

▶▶ Adjusting the Front Head Restraint Positions

⚠ WARNING

Improperly positioning head restraints reduces their effectiveness and increases the likelihood of serious injury in a crash.

Make sure head restraints are in place and positioned properly before driving.

In order for the head restraint system to work properly:

- Do not hang any items on the head restraints, or from the restraint legs.
- Do not place any objects between an occupant and the seat-back.
- Install each restraint in its proper location.

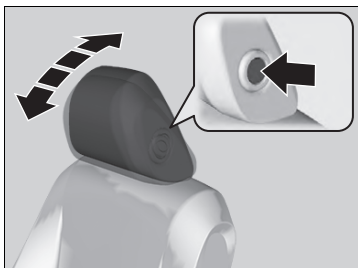

To tilt the head restraint forward:

Push the back of it forward.

To tilt the head restraint backward:

Push it backward while pressing the release button on the side of the head restraint.

■ Changing the Rear Seat Head Restraint Position

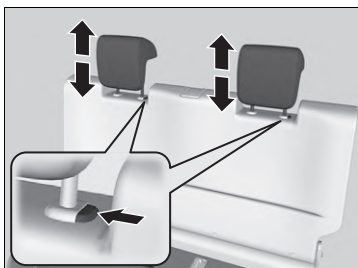

A passenger sitting in the rear seating position should adjust the height of their head restraint to an appropriate position before the vehicle begins moving.

To raise the head restraint:

Pull it upward.

To lower the head restraint:

Push it down while pressing the release button.

☒ Changing the Rear Seat Head Restraint Position

When you use the head restraint in the rear seating position, pull up the head restraint to its highest position. Do not use it in any lower position.

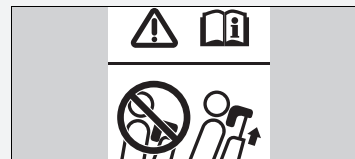

■ Removing and Reinstalling the Head Restraints

Head restraints can be removed for cleaning or repair.

To remove a head restraint:

Pull the restraint up as far as it will go. Then push the release button, and pull the restraint up and out.

To reinstall a head restraint:

Insert the legs back in place, then adjust the head restraint to an appropriate height while pressing the release button. Pull up on the restraint to make sure it is locked in position.

⌘ Removing and Reinstalling the Head Restraints

WARNING

Failure to reinstall, or correctly reinstall, the head restraints can result in severe injury during a crash.

Always replace the head restraints before driving.

Interior Lights

Interior Light Switches

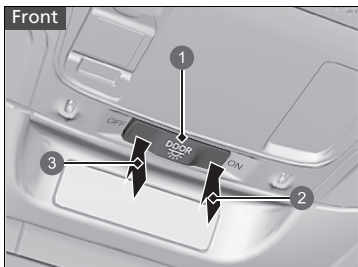

- 1 Door activated position
- 2 On
- 3 Off

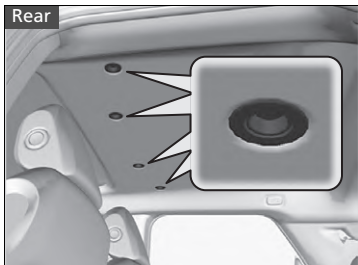

■ ON

The interior lights come on regardless of whether the doors are open or closed.

■ Door activated

The interior lights come on in the following situations:

- When any doors are opened.
- You unlock the driver's door.
- When the power mode is set to VEHICLE OFF.
- When you shift to **[P]** while power system is on.
- When you unfasten the seatbelt.

■ OFF

The interior lights remain off regardless of whether the doors are open or closed.

Interior Light Switches

In the door activated position, the interior lights fade out and go off about 30 seconds after the doors are closed.

The lights go off after about 30 seconds in the following situations:

- When you unlock the driver's door but do not open it.
- When you set the power mode to VEHICLE OFF but do not open a door.

You can change the interior lights dimming time.

■ How to Customize the Vehicle Settings

P. 331

The interior lights go off immediately in the following situations:

- When you lock the driver's door.
- When you close the driver's door in ACCESSORY mode.
- When you set the power mode to ON by pressing the **POWER** button.
- When you set the shift position to other than **[P]**.

If you leave any of the doors open in VEHICLE OFF mode, the interior lights go off after about 15 minutes.

To avoid draining the battery, do not leave the interior light on for an extended length of time when the power system is off.

Map Lights

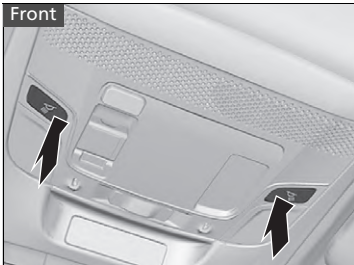

■ Front seat

The map lights can be turned on and off by pressing the button.

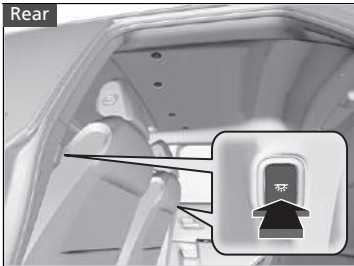

■ Rear seat

The map lights can be turned on and off by pressing the button.

Map Lights

When the front interior light switch is in the door activated position and any door is open, the map light will not go off when you press the buttons.

■ Luggage Area Lights

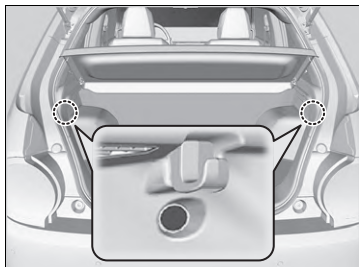

The lights come on when you open the tailgate.

Storage Items

■ Glove Box

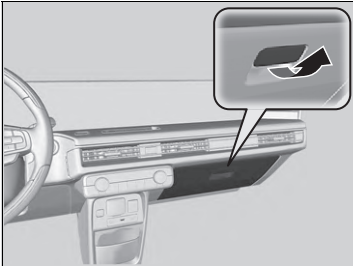

Pull the handle to open the glove box.

■ Centre Console

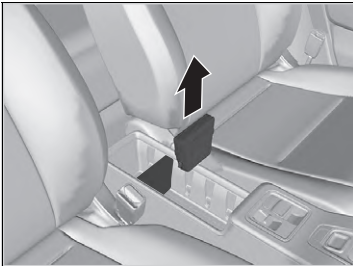

Are located in the console between the front seats.

You can create more storage space by removing the divider.

☒ Glove Box

⚠ WARNING

An open glove box can cause serious injury to your passenger in a crash, even if the passenger is wearing the seat belt.

Always keep the glove box closed while driving.

■ Beverage Holders

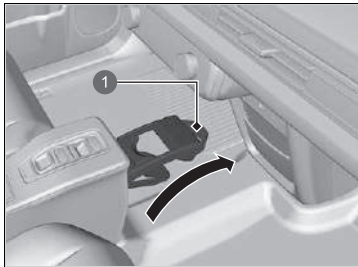

1 Band

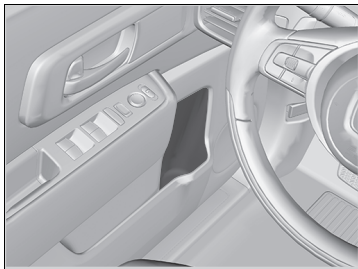

■ Front seat beverage holders

Are located at the front side of the console.

Pull the band to use it.

■ Front door side beverage holders

Are located on the both of front door side pockets.

► Beverage Holders

NOTICE

Spilled liquids can damage the upholstery, carpeting, and electrical components in the interior.

Be careful when you are using the beverage holders. Hot liquid can scald you.



■ **Rear door side beverage holders**

Are located on the both of rear door side pockets.

■ Tie-down Anchors

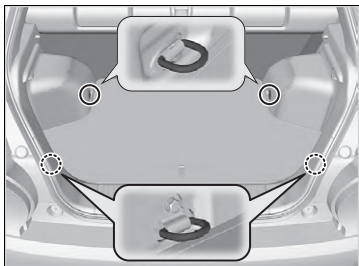

The tie-down anchors on the luggage area floor can be used to install a net for securing items.

■ Luggage Hook

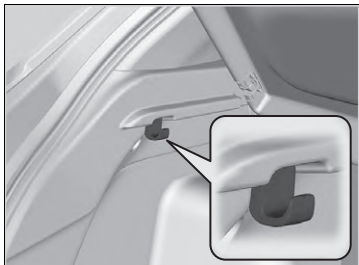

The luggage hooks on both sides of the luggage area can be used to hang a light items.

» Tie-down Anchors

Do not let anyone access items in the luggage area while driving. Loose items can cause injury if you have to brake hard.

» Luggage Hook

NOTICE
Do not hang a large object or an object that weighs more than 3 kg (6 lbs) on the side luggage hook. Hanging heavy or large objects may damage the hook.

■ Luggage Area Cover

The luggage area cover may be removed to give you more luggage room.

■ To remove the luggage area cover

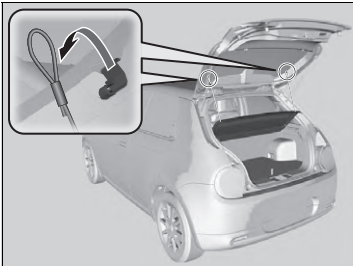

1. Open the tailgate.
2. Remove the strap on each side of the tailgate.

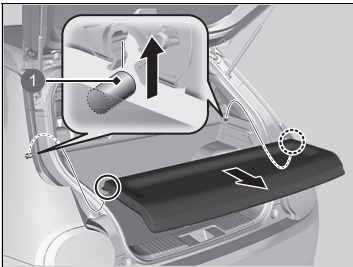

3. Disengage the support rods, then remove the luggage area cover.

Reverse this procedure to install the luggage area cover.

After reinstalling the luggage area cover, make sure it is latched securely.

① Support Rod

▣ Luggage Area Cover

Do not place items on the luggage area cover, or stack objects higher than the top of the back seat. They could block your view and be thrown around the vehicle during a crash or sudden stop.

Do not apply excessive pressure to the cover, such as leaning on it to retrieve an item.

Other Interior Convenience Items

■ Accessory Power Socket

The accessory power socket can be used when the power mode must be in ACCESSORY or ON.

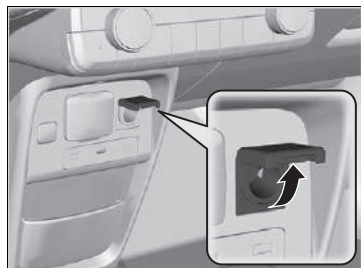

■ Console panel

Open the cover to use it.

»» Accessory Power Socket

NOTICE

Do not insert an automotive type cigarette lighter element. This can overheat the power socket.

The accessory power socket is designed to supply power for 12-volt DC accessories that are rated 180 watts (15 amps) or less.

To prevent 12-volt battery drain, only use the power socket with the power system on.

When the power socket is not in use, close the cover to prevent any small foreign objects from getting into the power socket.

AC Power Outlet*

The AC power outlet can be used when the power mode is in ON.

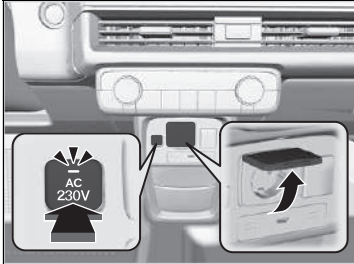

Open the cover to use it. Plug in the appliance, then push the **AC 230V** button.

AC Power Outlet*

NOTICE

Do not use the AC power outlet for electric appliances that require high initial peak wattage such as refrigerators, electric pumps, etc. It is not suitable for devices that process precise data, such as medical equipment, and that require an extremely stable power supply, such as microcomputer-controlled electric blankets, touch sensor lamps, etc.

The AC power outlet is designed to supply power for up to 230 volt appliances that are rated 1500 watts or less.

Continued use of any electric appliance/device exceeding these ratings may result in damage to the appliance/device.

When the AC power outlet is not in use, close the cover to prevent any small foreign objects from getting into the AC power outlet.

Refrain from using heat-generating electrical equipment or cooking utensils that cannot be secured while driving.

You may hear static on the radio depending on the electrical equipment in use.

* Not available on all models

■ Heated Steering Wheel

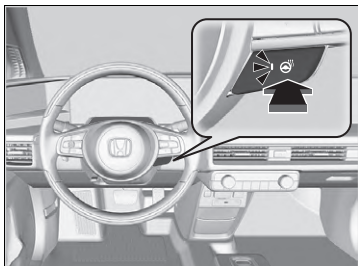

The power mode must be in ON to use the heated steering wheel.

Press the button on the right side of the steering wheel.

When a comfortable temperature is reached, press the button again to turn it off.

The heated steering wheel is turned off every time you turn the power system on, even if you turned it on the last time you drove the vehicle.

▣ Heated Steering Wheel

Do not use the heated steering wheel continuously when the power system is off. Under such conditions, the 12-volt battery may be weakened, making it difficult to turn the power system on.

When the remote climate pre-conditioning is on, the heated steering wheel may turn on automatically, depending on the ambient temperature.

■ Front Seat Heaters



The power mode must be in ON to use the seat heaters.

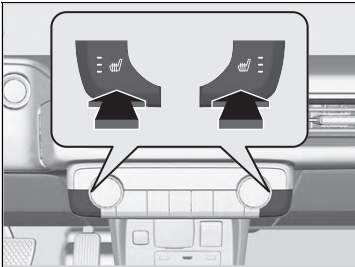

Press the seat heater button:

- Once - The HI setting (three indicators on)
- Twice - The MID setting (two indicators on)
- Three times - The LO setting (one indicator on)
- Four times - The OFF setting (no indicators on)

When the power mode is in ON after it is turned off, the previous setting of seat heaters is maintained.

☒ Front Seat Heaters

⚠ WARNING

Heat induced burns are possible when using seat heaters.

Persons with a diminished ability to sense temperature (e.g., persons with diabetes, lower-limb nerve damage, or paralysis) or with sensitive skin should not use seat heaters.

Do not use the seat heaters even in LO when the power system is off. Under such conditions, the 12-volt battery may be weakened, making it difficult to turn the power system on.

After a certain period of time, the strength setting for the seat heater will automatically be reduced by one level at a time until the seat heater shuts off. The elapsed time varies according to the interior environment.

When the remote climate pre-conditioning is on, the front seat heaters may turn on automatically, depending on the ambient temperature.





Using Automatic Climate Control

The automatic climate control system maintains the interior temperature you select. The system also selects the proper mix of heated or cooled air that raises or lowers the interior temperature to your preference as quickly as possible.

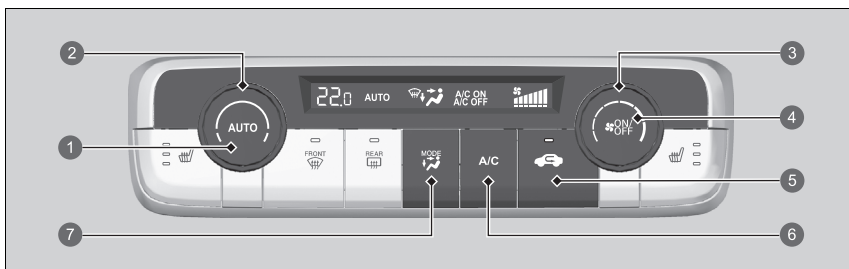
Use the system when the power system is on.

1. Press the **AUTO** button.
2. Adjust the interior temperature using the temperature control dial.
3. Press the  (ON/OFF) button to cancel.



- 1 **AUTO** Button*¹
- 2 Temperature Control Dial*¹
- 3 Fan Control Dial*¹
- 4 **ON/OFF** Button*¹
- 5 Recirculation Button*¹
- 6 **A/C** (Air Conditioning) Button*¹
- 7 **MODE** Control Button
 -  Air flows from dashboard vents
 -  Air flows from dashboard and floor vents
 -  Air flows from floor vents
 -  Air flows from floor and windscreen demister vents

*1: Left-hand drive types are shown. For the right-hand drive types, these buttons are located at the symmetrically opposite to the left-hand drive type.

Using Automatic Climate Control

If any buttons are pressed while using the climate control system in auto, the function of the button that was pressed will take priority.



The **AUTO** indicator will go off, but functions unrelated to the button that were pressed will be controlled automatically.

To prevent cold air from blowing in from outside, the fan may not start immediately when the **AUTO** button is pressed.

If the interior is very warm, you can cool it down more rapidly by partially opening the windows, turning the system on auto, and setting the temperature to low. Change the fresh mode to recirculation mode until the temperature cools down.

When you set the temperature to the lower or upper limit, **Lo** or **Hi** is displayed.

Pressing the  button switches the climate control system between on and off. When turned on, the system returns to your last selection.

When the  or  mode is active, depending on conditions like the temperature and the humidity, the heater inside the front windscreen may turn on automatically.

■ Switching between the recirculation and fresh air modes

Press the  (recirculation) button and switch the mode depending on environmental conditions.

Recirculation mode (indicator on): Recirculates air from the vehicle's interior through the system.

Fresh air mode (indicator off): Maintains outside ventilation. Keep the system in fresh air mode in normal situations.

⌘ Using Automatic Climate Control

The High Voltage battery level being low may reduce the climate control system performance.

Continued

■ Defrosting the Windscreen and Windows

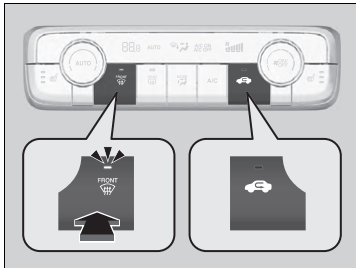

Pressing the  (windscreen demister) button turns the air conditioning system on and automatically switches the system to fresh air mode.

Press the  button again to turn off, the system returns to the previous settings.

■ To rapidly defrost the windows

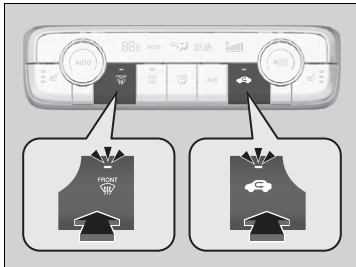

1. Press the  button (indicator on).
2. Press the  button (indicator on).

►► Defrosting the Windscreen and Windows

For your safety, make sure you have a clear view through all the windows before driving.

Do not set the temperature near the upper or lower limit.

When cold air hits the windscreen, the outside of the windscreen may fog up.

When you press the  button, the heater inside the front windscreen will also turn on.

►► To rapidly defrost the windows

After defrosting the windows, switch over to fresh air mode. If you keep the system in recirculation mode, the windows may fog up from humidity. This impedes visibility.

Remote Climate Pre-Conditioning

You can operate the climate control system from outside the vehicle.

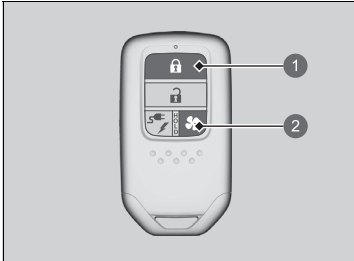

- 1 Lock Button
- 2 Climate Button

■ To turn on the system

1. Press the lock button.
 - ▶ Some exterior lights flash.
2. Within about five seconds, press and hold the climate button.
 - ▶ Some exterior lights flash.
 - ▶ After a few seconds, some exterior lights flash six times and the climate control system is turned on.

■ To turn off the system

- Press and hold the climate button.
- ▶ Some exterior lights flash and the climate control system is turned off.

Remote Climate Pre-Conditioning

⚠ WARNING

Make sure that no one is inside the vehicle when you use the remote climate control system. After a certain period of time has elapsed, the system shuts off temporarily. During this time, the interior of the vehicle may heat up or cool down depending on ambient temperatures. If a child is left inside the vehicle, extreme temperature exposure can result in death or serious injury of the child.

The climate control system does not operate when any of the following conditions are met.

- A door or the bonnet is not closed.
- The power mode is set to ON.
- The High Voltage battery level is low.

The climate control system automatically turned off when any of the following conditions are met.

- The system has been operated for more than time your set.
- The High Voltage battery level becomes low.
- A bonnet is opened.
- The power mode is set to ON.

▶▶ Remote Climate Pre-Conditioning

The following functions also operate according to the temperature:

When it is warm outside:

- The air conditioning is activated in recirculation mode.

When it is cold outside:

- The heater inside the front screen is activated as necessary.
- The rear demister is activated.
- The seat heater and heated steering wheel are activated.

▶▶ **Heated Steering Wheel** P. 244

▶▶ **Front Seat Heaters** P. 245

Depending on the charging environment, the charge amount of High Voltage battery may be reduce even if the charging connector is plugged in.

You can adjust the pre-conditioning temperature, change the operation time, and turn off the automatic defroster by using the audio/information screen.

▶▶ **EV Menu** P. 317

You can customize the settings of the climate control system schedule.

▶▶ **EV Menu** P. 317

Automatic Climate Control Sensors

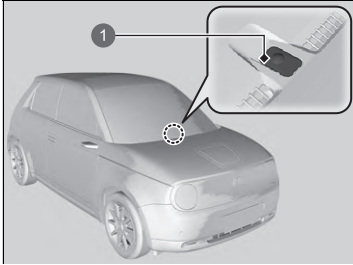

The automatic climate control system is equipped with sensors. Do not cover or spill any liquid on them.

1 Sensor

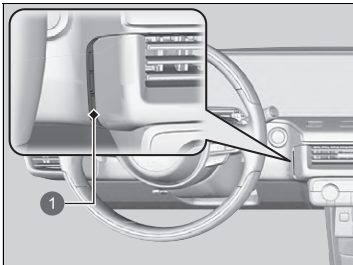

1 Sensor

Features

This chapter describes how to operate technology features. Images throughout this chapter illustrate representative examples.

Audio System

About Your Audio System	254
Audio System Theft Protection	255
Display Audio	256
Start Up	256
Basic Operation	257
On-Board Owner's Manual	263
Voice Control Operation*1	264
Audio/Information Screen	267
Clock Setup	273
Adjusting the Sound	276
Display Setup	277

System Updates	278
Playing FM Radio	283
Playing DAB (Digital Audio Broadcasting)	288
Playing an iPod	291
Playing a USB Flash Drive	294
Playing <i>Bluetooth</i> ® Audio	298
Playing a Video Using the HDMI™	301
Wi-Fi Connection	303
Apple CarPlay	305
Android Auto™	309
Power Flow	313

EV Menu	317
Driver Assist System On and Off	322
Customized Features	323
Defaulting All the Settings	338
Hands-Free Telephone System	339
Audio Error Messages	357
General Information on the Audio System	358
Emergency Call (eCall)	368

About Your Audio System

The audio system features FM radio and Digital Audio Broadcasting (DAB) service. It can also play USB flash drives, iPod, iPhone, *Bluetooth*® devices, smartphone, and HDMI™ devices.

You can operate the audio system from the buttons and volume knob on the panel, the remote controls on the steering wheel or the icons on the touchscreen interface.

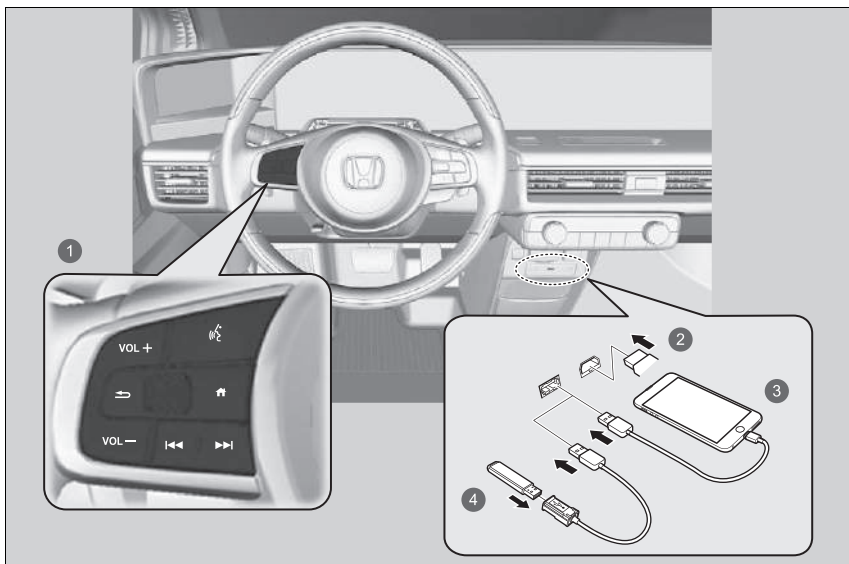

- 1 Remote Controls
- 2 HDMI™
- 3 iPod
- 4 USB Flash Drive

About Your Audio System

Key Off Operation

After you set the power mode to VEHICLE OFF (LOCK), you can use the audio system for up to 30 minutes per driving cycle. However, whether you can continue using the audio system depends on the battery condition. Repeatedly using this feature may drain the battery.

Audio System Theft Protection

The audio system is disabled when it is disconnected from the power source, such as when the 12-volt battery is disconnected or goes dead. In certain conditions, the system may display a code entry screen. If this occurs, reactivate the audio system.

■ Reactivating the audio system

1. Set the power mode to ON.
2. Turn on the audio system.
3. Press and hold the audio system power button for more than two seconds.
 - ▶ The audio system is reactivated when the audio control unit establishes a connection with the vehicle control unit. If the control unit fails to recognise the audio unit, you must go to a dealer and have the audio unit checked.

Start Up

The Display Audio starts automatically when you set the power mode to ACCESSORY or ON. At start-up, the following screen about the data upload will be displayed.

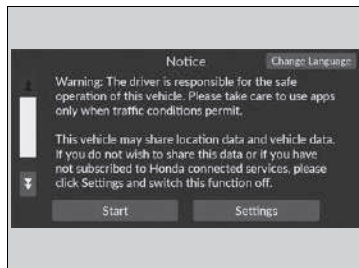

Select **Start**.

- ▶ If you want to change the settings for data upload, select **Settings**, then select the ON/OFF settings on the **Location and vehicle data sharing** screen.
- ▶ If you do not select **Start**, the system will automatically be switched the audio/ information screen after a certain period of time.
- ▶ If there is no registered device, select **Start** and the *Bluetooth*® pairing screen will be displayed.
- ▶ If you check the box with **Do not show this again**, this screen will not be displayed.

■ To pair a mobile phone (when there is no phone paired to the system)

1. Make sure your phone is in search or discoverable mode.
2. Select **Honda HFT** from your phone.
 - ▶ If you want to pair a phone from this Display Audio, select **Search for Devices**, and then select your phone when it appears on the list.

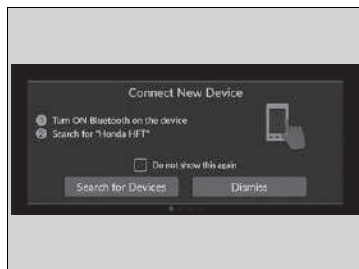

Start Up

Location and vehicle data sharing

ON: Available the data communication.

OFF: Not available the data communication.

Basic Operation

Audio System Function

To use the audio system function, the power mode must be in ACCESSORY or ON.

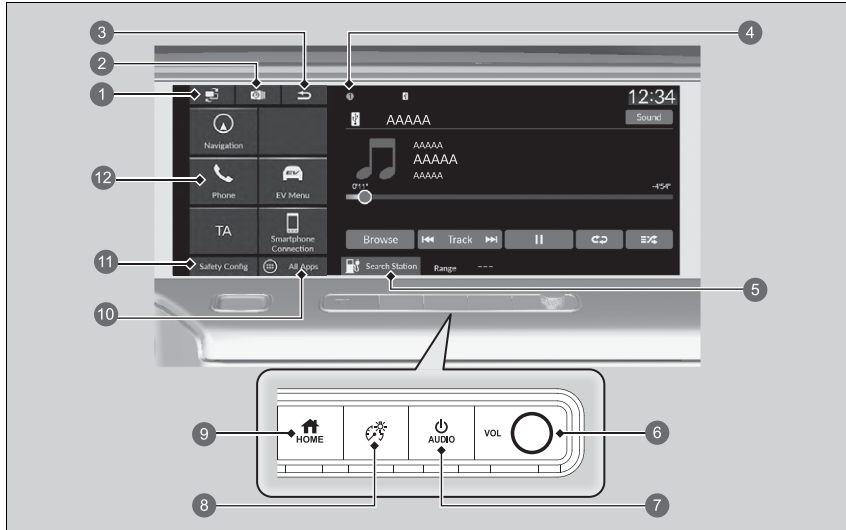

- | | |
|-------------------------|-------------------------|
| 1 (Screen Switch) Icon | 7 (Power/Audio) Button |
| 2 (Recent) Icon | 8 (Brightness) Button |
| 3 (Back) Icon | 9 (Home) Button |
| 4 Status Icons | 10 All Apps |
| 5 Search Station | 11 Safety Config |
| 6 VOL Knob | 12 Shortcut Icon |

Audio System Function

This screen is shown for the left-hand drive models. For the right-hand drive models, these are located at the symmetrically opposite to the left-hand drive model.

You can use the audio system for 30 minutes when the power mode is in VEHICLE OFF, the system will then turn off automatically. If you want to keep using it, we recommend that you set the power mode to ACCESSORY or ON.

Key Off Operation

▶ Key Off Operation P. 254

 **(Screen Switch) Icon:** Switches the apps shown on the centre screen and assistant screen.

➤ **Switching the Screen** P. 268

 **(Recent) Icon:** Displays the app history list.

➤ **Displaying the App History** P. 268

 **(Back) Icon:** Goes back to the previous screen.

Status Icons: Shows the indicators of the information for the vehicle, connected phones, etc. in the header area.

➤ **Status Area** P. 270

 **Search Station:** Searches a charging station.

➤ **See the Navigation System Manual**

VOL Knob: Turns to adjust the volume.

 **(Power/Audio) Button:** Turns the audio system on and off.

 **(Brightness) Button:** Changes the screen brightness.

➤ **Display Setup** P. 277

 **(Home) Button:** Goes to the home screen.

 **All Apps:** Displays the all apps.

Safety Config: Turns the safety functions on and off.

➤ **Driver Assist System On and Off** P. 322

Shortcut Icon: Displays the shortcut icons.

USB Ports

On the front panel

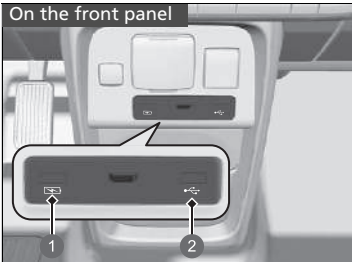

- 1 Only for charging devices
- 2 Playing audio files and connecting compatible phones

■ On the front panel (🔌)

The USB port (2.5A) on the front panel is for charging devices, playing audio files and connecting compatible phones with Apple CarPlay or Android Auto.

- ▶ To prevent any potential issues, be sure to use an Apple MFi Certified Lightning Connector for Apple CarPlay, and for Android Auto, the USB cables should be certified by USB-IF to be compliant with USB 2.0 Standard.

■ On the front panel (🔌)

The USB port (2.5A) on the front panel is only for charging devices.

- ▶ You cannot play music even if you have connected music players to it.

■ On the back of the console compartment

These USB ports (2.5A) are only for charging devices.

- ▶ You cannot play music even if you have connected music players to them.

On the back of the console compartment

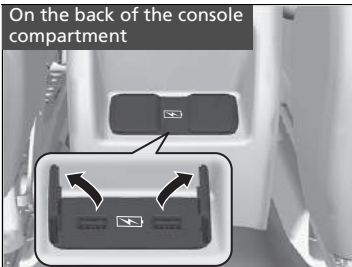

USB Ports

- Do not leave the iPod or USB flash drive in the vehicle. Direct sunlight and high temperatures may damage it.
- We recommend that you use a USB cable if you are attaching a USB flash drive to the USB port.
- Do not connect the iPod or USB flash drive using a hub.
- Do not use a device such as a card reader or hard disk drive, as the device or your files may be damaged.
- We recommend backing up your data before using the device in your vehicle.
- Displayed messages may vary depending on the device model and software version.

USB charge

The USB port can supply up to 2.5A of power. It does not output 2.5A unless requested by the device. For amperage details, read the operating manual of the device that needs to be charged.

Under certain conditions, a device connected to the port may generate noise in the radio you are listening to.

■ HDMI™ Port



Install the HDMI™ cable to the HDMI™ port.

☒ HDMI™ Port

- Do not leave the HDMI™ connected device in the vehicle. Direct sunlight and high temperatures may damage it.
- We recommend backing up your data before using the device in your vehicle.
- Displayed messages may vary depending on the device model and software version.

The terms HDMI and HDMI High-Definition Multimedia Interface, and the HDMI Logo are trademarks or registered trademarks of HDMI Licensing LLC in the United States and other countries.

Audio Remote Controls

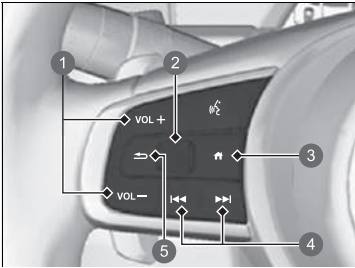

Allow you to operate the audio system while driving. The information is shown on the driver information interface.

- ① **VOL +** / **VOL -** (Volume) Buttons
- ② Left Selector Wheel
- ③ **Home** Button
- ④ **Seek/Skip** Buttons
- ⑤ **Back** Button

VOL + / **VOL -** (Volume) Buttons

Press VOL +: To increase the volume.

Press VOL -: To decrease the volume.

Left Selector Wheel

- When selecting the audio mode

Press the **Home** button, then roll up or down to select **Audio** on the driver information interface, and then press the left selector wheel.

Audio Remote Controls

Some modes appear only when an appropriate device or medium is used.

Depending on the *Bluetooth*® device you connect, some functions may not be available.

Press the **Back** button for the driver information interface to go back to the previous screen or cancel a command.

Press the **Home** button to go back to the home screen of the driver information interface.











Roll up or down:

To cycle through the audio modes, roll up or down and then press the left selector wheel:

FM/DAB/iPod/USB/Apple CarPlay/Android Auto/*Bluetooth*® Audio/HDMI

► Depending on a connected device, the displayed modes may be changed.

(Seek/Skip) Buttons

- When listening to the radio
 - Press **: To select the next preset radio station.
 - Press **: To select the previous preset radio station.
 - Press and hold **: To select the next strong station.
 - Press and hold **: To select the previous strong station.
- When listening to an iPod, USB flash drive, *Bluetooth*® Audio, or Smartphone Connection
 - Depending on a connected device, operations may be changed.
 - Press **: To skip to the next song.
 - Press **: To go back to the previous song.
- When listening to a USB flash drive
 - Press and hold **: To skip to the next folder.
 - Press and hold **: To go back to the previous folder.
- When listening to an iPod:
 - Press and hold **: To skip to the next song.
 - Press and hold **: To go back to the previous song.

On-Board Owner's Manual

You can view the content of the owner's manual on the Display Audio.

■ Open the Owner's Manual

1. Select  **All Apps**.
2. Select **Owner's manual**.

■ Install/Update the Owner's Manual

When you can install or update the owner's manual, the notification will be sent automatically.

To update:

1. Tap the notification.
 - ▶ The version screen will display.
2. Select items to be updated.
3. Tap **Update**.

If you unselect an item on the version screen, you will not receive any notifications for it.

⌘ On-Board Owner's Manual

This function does not cover all languages available for the Display Audio.

Changing the language of the Display Audio will also change the language of the owner's manual. If the owner's manual is not available or installed in that language, the owner's manual will default to English.

⌘ Install/Update the Owner's Manual

There may be differences in the displayed content depending on the version of the owner's manual.

If the owner's manual is not installed yet, you can install it via Wi-Fi.



 **Wi-Fi Connection** P. 303

For languages except English, Germany, French, Italian and Spanish

If you install the owner's manual in a new language, the owner's manual you previously downloaded will be removed.

Voice Control Operation*1

Your vehicle has a voice control system that allows hands-free operation.

The voice control system uses the  (talk) and  (back) buttons on the steering wheel and a microphone near the map lights on the ceiling.

Voice Recognition

To achieve optimum voice recognition when using the voice control system:

- Make sure the correct screen is displayed for the voice command that you are using.

The system recognises only certain commands.

Available voice commands.

 **Voice Portal Screen** P. 265

- Close the windows.
- Adjust the dashboard and side vents so air does not blow onto the microphone on the ceiling.
- Speak clearly in a clear, natural speaking voice without pausing between words.
- Reduce any background noise if possible. The system may misinterpret your command if more than one person is speaking at the same time.

Voice Control Operation*1

When you press the  button, a helpful prompt asks what you would like to do. Press and release the button again to bypass this prompt and give a command.

*1: Languages that the voice control system recognises are English, German, French, Spanish, and Italian.

Voice Portal Screen

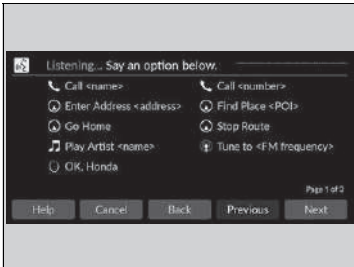

When the  (talk) button is pressed, available voice commands appear on the screen.

For a complete list of commands, say “*Help*” after the beep.

Depending on the selected mode, the displayed commands are different on the voice portal screen. The commands recognised are the same regardless of which screen is selected.

Normal Mode: A list of example commands is displayed to quickly complete your desired function.

Assist Mode: A list of basic commands is displayed to guide you step by step through the voice menu.

You can change the mode on the **General Settings** screen.

 **Voice Control** P. 330

The system only recognises the commands on the following pages, at certain screens. Free form voice commands are not recognised.

General Commands

When the voice portal screen is displayed, it will change to the top screen of each function by using the global commands.

- *Music Search*
- *FM*
- *Navigation*
- *Phone*
- *OK Honda*

Phone Commands

This can be only used when the phone is connected. When the system recognises the Phone command, the screen will change the dedicated screen for the voice recognition of the phone.

Phone Commands

- *Call <name>*
- *Call <number>*

The system recognises an only contact name in the stored phonebook of your phone. If full name is registered in first name field, the system will recognise the first name and last name as one contact name.

Phone commands are not available if using Apple CarPlay.

Audio Commands

When the system recognises the Audio command, the screen will change the dedicated screen for the voice recognition of the audio.

FM Commands

- *Tune to <FM frequency>*

■ iPod Commands

- *List Album <name>*
- *List Artist <name>*
- *List Genre <name>*
- *List Playlist <name>*
- *Play <artist> <album>*
- *Play*
- *Play Album <name>*
- *Play Artist <name>*
- *Play Genre <name>*
- *Play Music <text:media_combo>*
- *Play Playlist <name>*
- *Play Song <name>*

■ USB Commands

- *List Album <name>*
- *List Artist <name>*
- *List Playlist <name>*
- *Play <artist> <album>*
- *Play*
- *Play Album <name>*
- *Play Artist <name>*
- *Play Music <text:media_combo>*
- *Play Playlist <name>*
- *Play Song <name>*

■ Navigation Commands

The screen changes to the navigation screen.

☒ **Refer to the Navigation System Manual**

■ Standard Commands

- *Voice Help*
- *Cancel*
- *Back*

Voice Help are readout voice guidance for Help on current screen.

■ List Commands

- *Previous*
- *Next*
- *Yes*
- *No*

Audio/Information Screen

Displays the audio status and images are input from the outside on the centre screen and assistant screen. From these screens, you can go to various setup options.

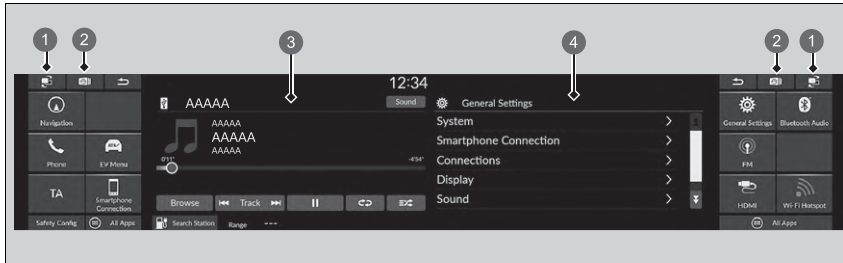

- ① (Screen Switch) Icon
- ② (Recent) Icon
- ③ Centre Screen
- ④ Assistant Screen

Audio/Information Screen

Touchscreen Operation

- Use simple gestures - including touching, swiping, and scrolling - to operate certain audio functions.
- Some items may be grayed out during driving to reduce the potential for distraction.
- You can use voice commands.
- Wearing gloves may limit or prevent touchscreen response.

You can change the touchscreen sensitivity setting.

➤ **System P. 324**

■ Switching the Screen

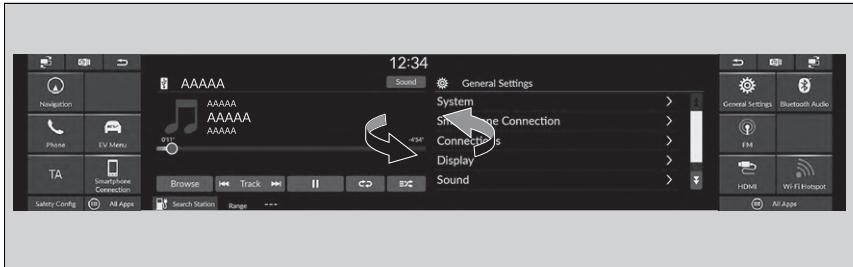

Select  to switch the apps shown on the centre screen and assistant screen.

■ Displaying the App History



Select  to display the app history.

To close the app, swipe it upward.

► Switching the Screen

Some apps are displayed only on the centre screen.

■ App Shortcut Function

App shortcut icons are displayed on the centre screen and assistant screen. You can change the icons to be displayed and location of them.

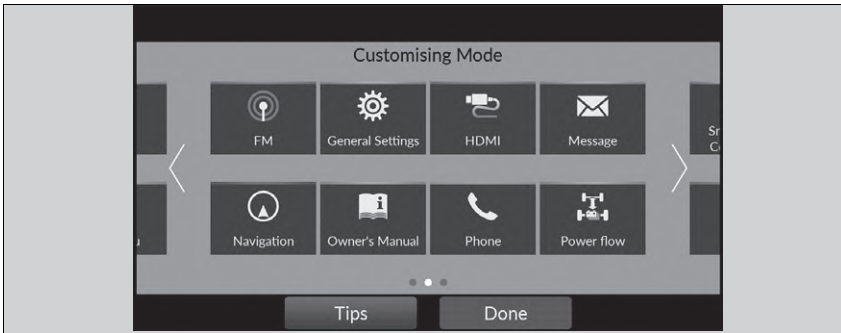

■ To change/move app shortcut icons on the shortcut area

You can change the displayed icons and location of the icons on the shortcut area.

1. Select and hold an icon.
 - ▶ The screen switches to the customization screen.
2. Drag and drop the icon to where you want it to be.
 - ▶ Selecting ◀ or ▶, swiping the customization screen left or right changes to the next screen.
3. Select **Done**.
 - ▶ It will return to the previous screen.

☒ App Shortcut Function

Select **Tips** to show tips. To hide them, touch the tips screen.

If there is a blank area on the shortcut area, you can add an icon to be displayed. If so, press and hold the blank area to switch the customization screen.

Pre-installed apps may not start up normally. If this occurs, select  (recent) and swipe the apps which cannot start up upward to close it, then re-start the apps.

In case those apps still do not start up normally, you need to turn the power mode to VEHICLE OFF and set the power mode to ON again.

☒ **Displaying the App History** P. 268

If you perform **Factory Data Reset**, it may reset all the settings to their factory default.

☒ **Defaulting All the Settings** P. 338

In case those apps still do not start up normally even after **Factory Data Reset**, contact your dealer.

■ Status Area

Shows the indicators of the information for the vehicle, connected phones, etc. in the header area. You can confirm the detail information by selecting these icons.

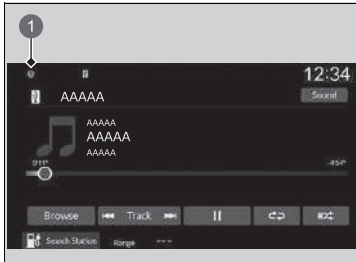

1. Select the system status icon.
 - ▶ The status area appears.
2. Select an item to see the details.
3. Select  or the system status icon to close the area.

① System Status Icon

Wallpaper Setup

You can change, store, and delete the wallpaper on the audio/information screen.

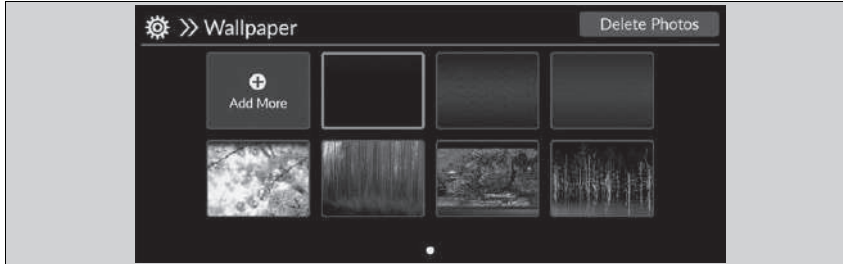

Import wallpaper

1. Connect the USB flash drive to the USB port.
 - ▶ **USB Ports** P. 259
2. Select **General Settings**.
3. Select **Display**.
4. Select **Wallpaper**.
5. Select **Add More**.
 - ▶ The image of the pictures stored in the USB flash drive are displayed on the list.
6. Select a desired picture to import.
 - ▶ Multiple pictures can be selected at the same time.
7. Select **OK**.
 - ▶ The selected pictures are displayed.
8. Select **Transfer**.
 - ▶ It will return to the wallpaper setting screen.

Wallpaper Setup

The wallpaper you set up on **Wallpaper** cannot be displayed on the driver information interface.

- When importing wallpaper files, the image must be in the USB flash drive's root directory. Images in a folder cannot be imported.
- The file name must be less than 64 bytes.
- The file format of the image that can be imported is BMP (bmp) or JPEG (jpg).
- The individual file size limit is less than 10 MB.
- If the USB flash drive does not have any pictures, the message appears.
- Up to 16 pictures can be imported.
- The maximum image size is 4,096 × 2,304 pixels. If the image size is less than 1,280 × 720, the image is displayed in the middle of the screen with the extra area appearing in black.
- If the size of the added picture is larger than the screen area, it will maintain the aspect ratio of the picture data and be reduced to fit the screen area.

■ Select wallpaper

1. Select **General Settings**.
2. Select **Display**.
3. Select **Wallpaper**.
4. Select a desired wallpaper to set.
 - ▶ If the imported images are not displayed on the audio/information screen, select  on the screen.
 - ▶ The preview is displayed on the screen.
5. Select **Save**.
 - ▶ It will return to the wallpaper setting screen.

■ Delete wallpaper

1. Select **General Settings**.
2. Select **Display**.
3. Select **Wallpaper**.
4. Select **Delete Photos**.
5. Select a desired wallpaper to delete.
 - ▶ Multiple pictures can be selected at the same time.
6. Select **OK**.
 - ▶ The selected pictures are displayed.
7. Select **Delete**.
 - ▶ It will return to the wallpaper setting screen.

⌘ Delete wallpaper

You cannot delete the initial imported wallpapers.

Clock Setup

■ Adjusting the Clock

You can adjust the time manually and set the wallpaper of the clock in the audio/information screen.

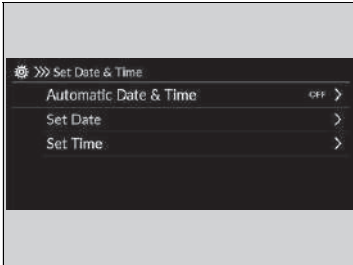

1. Select **General Settings**.
2. Select **System**.
3. Select **Date & Time**.
4. Select **Set Date & Time**.
5. Select **Automatic Date & Time**, then select **OFF**.

To adjust date:

6. Select **Set Date**.
7. Select ▲/▼.
8. Select **Save** to set the date.

To adjust time:

6. Select **Set Time**.
7. Select ▲/▼.
8. Select **Save** to set the time.

⌘ Adjusting the Clock

The clock is automatically updated through the audio system.

You can also adjust the clock by touching the clock displayed on the header area of the centre screen, **Clock** displayed on the shortcut area, or **All Apps**.

1. Touch the clock on the screen. The clock screen of the face-type appears.
2. Select **Settings**.
3. Select **Date & Time**.
4. Select **Set Date & Time**.
5. Select **Automatic Date & Time**, then select **OFF**.
6. Select **Set Date** or **Set Time**.
7. Adjusting the dates, hours and minutes by selecting ▲/▼.
8. Select **Save** to set the time.

You can customise the clock display.

➤ **System** P. 324

■ Clock Wallpaper Setup

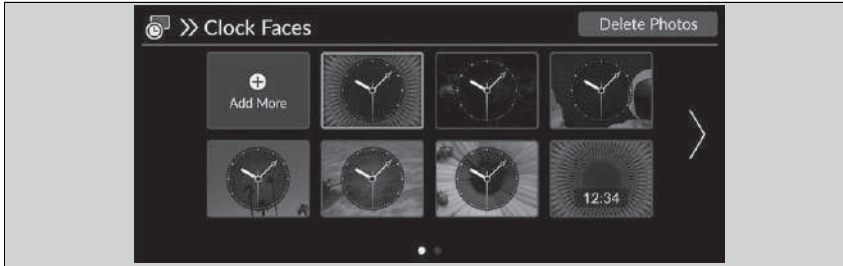

■ Import clock wallpaper

1. Connect the USB flash drive to the USB port.
▶ **USB Ports** P. 259
2. Select **Clock**.
▶ If **Clock** is not displayed on the shortcut area, select **All Apps**.
3. Select **Settings**.
4. Select **Clock Faces**.
5. Select **Add More**.
▶ The image of the pictures stored in the USB flash drive are displayed on the list.
6. Select a desired picture to import.
▶ Multiple pictures can be selected at the same time.
7. Select **OK**.
▶ The selected pictures are displayed.
8. Select **Transfer**.
▶ It will return to the clock wallpaper setting screen.

▶▶ Clock Wallpaper Setup

- When importing wallpaper files, the image must be in the USB flash drive's root directory. Images in a folder cannot be imported.
- The file name must be less than 64 bytes.
- The file format of the image that can be imported is BMP (bmp) or JPEG (jpg).
- The individual file size limit is less than 10 MB.
- If the USB flash drive does not have any pictures, the message appears.
- Up to 11 pictures can be imported.
- The maximum image size is 4,096 x 2,304 pixels. If the image size is less than 1,280 x 720, the image is displayed in the middle of the screen with the extra area appearing in black.

■ Select clock wallpaper

1. Select **Clock**.
 - ▶ If **Clock** is not displayed on the shortcut area, select  **All Apps**.
2. Select **Settings**.
3. Select **Clock Faces**.
4. Select a desired picture to set.
 - ▶ The preview is displayed on the screen.
5. Select **Save**.
 - ▶ The clock screen which the wallpaper has been set is displayed.

■ Delete clock wallpaper

1. Select **Clock**.
 - ▶ If **Clock** is not displayed on the shortcut area, select  **All Apps**.
2. Select **Settings**.
3. Select **Clock Faces**.
4. Select **Delete Photos**.
5. Select a desired picture to delete.
 - ▶ Multiple pictures can be selected at the same time.
6. Select **OK**.
 - ▶ The selected pictures are displayed.
7. Select **Delete**.
 - ▶ It will return to the clock wallpaper setting screen.

Adjusting the Sound

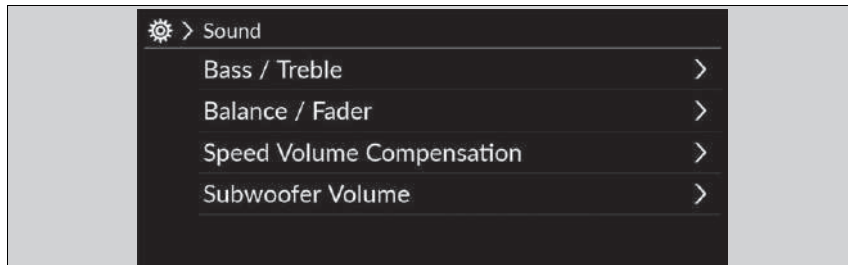

1. Select an audio source.
2. Select **Sound**.
3. Select the setting you want.

Select an item from the following choices:

- **Bass / Treble:** Treble, Midrange, Bass
- **Balance / Fader:** Balance, Fader
- **Speed Volume Compensation:** Sets the amount of volume increase.
- **Subwoofer Volume:** Sub Woofer, Centre Speaker

Adjusting the Sound

The **Speed Volume Compensation** (SVC) adjusts the volume level based on the vehicle speed. As you go faster, audio volume increases. As you slow down, audio volume decreases.

You can also adjust the sound the following procedure.

1. Select **General Settings**.
2. Select **Sound**.

To reset each setting for **Bass / Treble**, **Balance / Fader**, **Speed Volume Compensation**, and **Subwoofer Volume**, select **Default** on each setting screen.

Display Setup

The brightness of the screens, which are included the meter, centre screen and camera mirror system, is automatically adjusted depending on the surrounding brightness.

The brightness of the screens which have been automatically adjusted can be adjusted manually.

■ Changing the Screen Brightness

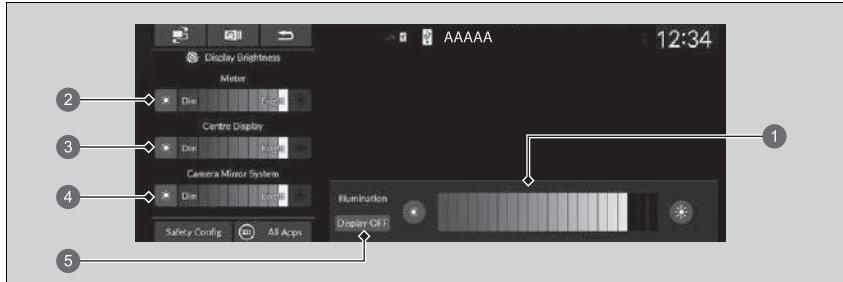

- ① Meter and Centre Screen Brightness
- ② Meter Brightness
- ③ Centre Screen Brightness
- ④ Camera Mirror System Brightness
- ⑤ **Display OFF**

1. Press the (Brightness) button.
 - ▶ The brightness bar is displayed for a few seconds.
 - **Basic Operation** P. 257
2. Select or to adjust the brightness.

▣ Changing the Screen Brightness

The screens' brightness will gradually be adjusted darker automatically as ambient light decreases. You can adjust the brightness of the screens when the ambient light is low.

The screens can also be adjusted in high ambient light, but the screens' brightness will not change.

You can adjust the screen brightness by swiping or tapping on the brightness bar.

Centre Screen

You can also change the centre screen brightness on the following procedures.

1. Select **General Settings**.
2. Select **Display**.
3. Select **Image Quality Adjustment**.
4. Select the setting you want.

To reset the centre display setting, select **Default** on the **Display** screen.

When the brightness bar is displayed, you can increase the brightness of the meter and centre screen by pressing the (brightness) button.



System Updates

The audio system's firmware can be updated with the telematics control unit (TCU) through the subscription-based service.

How to Update

When the audio system update is available, the notification is shown on the status area. Use the following procedure to update the system.

1. Select **System Updates**.

- ▶ If **System Updates** is not displayed on the shortcut area, select  **All Apps**.
- ▶ The system will check for updates.
- ▶ If the update icon is appeared on the status area, select the status icon.
 **Status Area** P. 270

2. Select **Download**.

- ▶ A notification appears on the screen if need to user acceptance for download.

3. Select **Install Now** or **Install While Vehicle Off**.

- ▶ A notification appears on the screen if the update is ready.

How to Update

You can update the system via Wi-Fi, but cannot use the captive portal that require login or agreement the terms of use on the browser.

Your download will be cancelled if:

- Your Wi-Fi connection is severed.
- You turn off the power system when the 12-volt battery is low on power.

Your download will recommence the next time a Wi-Fi connection is established.

For the 12-volt battery protection, **Install While Vehicle Off** cannot be selected when the battery is low on power. If you want to install the updated data, recharge the battery or select **Install Now**.

■ System Updates Settings

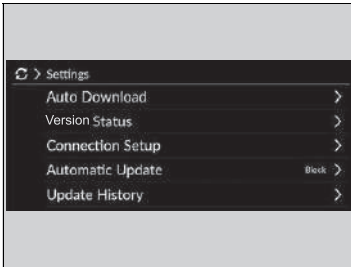

The following settings can be set.

- **Auto Download**
- **Version Status**
- **Connection Setup**
- **Automatic Update**
- **Update History**

■ Automatic download settings

Use the following procedure to change to the automatic download setting.

1. Select System Updates.

▶ If **System Updates** is not displayed on the shortcut area, select  **All Apps**.

2. Select Settings.

3. Select Auto Download.

4. Select the access point, then select Allow.

▶ If you do not want to system update automatically, select **Block**.

■ View a version and update status

Use the following procedure to confirm the version and update status.

1. Select System Updates.

▶ If **System Updates** is not displayed on the shortcut area, select  **All Apps**.

2. Select Settings.

3. Select Version Status.

■ Connection setup

Use the following procedure to connect to the Internet via a Wi-Fi network.

1. Select System Updates.

► If **System Updates** is not displayed on the shortcut area, select  **All Apps**.

2. Select Settings.

3. Select Connection Setup.

4. Select OK.

5. Select Change Mode.

6. Select Network.

► If the vehicle's Wi-Fi is turned off, select **OFF**.

■ Automatic update settings

Use the following procedure to change to the automatic update setting.

1. Select System Updates.

► If **System Updates** is not displayed on the shortcut area, select  **All Apps**.

2. Select Settings.

3. Select Automatic Update.

4. Select Accept.

► If you do not want to system update automatically, select **Decline**.

■ View the update history

Use the following procedure to confirm the update history.

1. Select System Updates.

► If **System Updates** is not displayed on the shortcut area, select  **All Apps**.

2. Select Settings.

3. Select Update History.

■ How to Update Wirelessly

■ Wireless connection mode setup

1. Select **System Updates**.
 - ▶ If **System Updates** is not displayed on the shortcut area, select  **All Apps**.
2. Select **Settings**.
3. Select **Connection Setup**.
4. Select **OK**.
5. Select **Change Mode**.
6. Select **Network**.
 - ▶ It will return to the network list.
7. Select an access point from the network list.
 - ▶ If the audio system requires a password, enter a password.
8. Select **Connect**.

■ How to update

1. Select **System Updates**.
 - ▶ If **System Updates** is not displayed on the shortcut area, select  **All Apps**.
2. Select **via Wireless**.
3. Select **Download**.
 - ▶ A notification appears on the screen if need to user acceptance for download.
4. Select **Install Now** or **Install While Vehicle Off**.
 - ▶ A notification appears on the screen if the update is ready.

■ How to Update with a USB Device

■ Download the update files from the server

1. Select **System Updates**.

- ▶ If **System Updates** is not displayed on the shortcut area, select  **All Apps**.

2. Select **Other Methods**.

3. Select **Via USB**.

- ▶ A notification appears on the screen.

4. Connect a USB device into the USB port.

- ▶ The inventory data is copied into the USB device.

 **USB Ports** P. 259

5. Remove the USB device from the USB port.

6. Connect the USB device into your computer, and then download the update files.

- ▶ Follow the link to download the required software update files. Refer to <https://usb.honda.com> for instructions.

■ Update the audio system

1. Select **System Updates**.

2. Select **Other Methods**.

3. Select **Via USB**.

- ▶ A notification appears on the screen.

4. Connect the USB device with the update files into the USB port.

- ▶ A notification appears on the screen.

 **USB Ports** P. 259

5. Select **Install Now**.

- ▶ A notification appears on the screen if the update is successful.

▣ How to Update with a USB Device

A USB device with a minimum of 8 GB of free space or more is recommended.

Be sure to delete any previous inventory or update files from the USB before starting the USB update process.

Playing FM Radio



- ① Settings Icon
- ② Sound Icon
- ③ Preset Icons
- ④ Station List Icon

- ⑤ Scan Icon
- ⑥ Tune Icon
- ⑦ Seek Icon

■ Preset Memory

Tunes the radio frequency for preset memory.

To store a station:

1. Tune to the selected station.
2. Select and hold the preset icon to store that station.
 - ▶ Selecting **Press & Hold** can be set a new preset station.

■ Station List

Lists the strongest stations on the selected band.

1. Select **Station List** to display a list.
2. Select the station.

■ Manual update

Updates your available station list at any time.



1. Select **Station List** to display a list.
2. Select **Refresh**.

■ Scan

Samples each of the strongest stations on the selected band for 10 seconds.

To begin scanning, select **Scan**, and to turn it off, select **Cancel** or .

■ Seek

Selects  or  to search the selected band up or down for a station with a strong signal.

▶▶ Preset Memory

The **ST** indicator appears on the display indicating stereo FM broadcasts.

Switching the Audio Mode

Roll up or down to select  (audio) on the left selector wheel.

 **Audio Remote Controls** P. 261

You can store 12 FM stations into preset memory.

■ Sound

Adjusts the sound settings.

📖 **Adjusting the Sound** P. 276

■ Radio Frequency Manual Tune Screen

Selects to use the on-screen keyboard for entering the radio frequency directly.

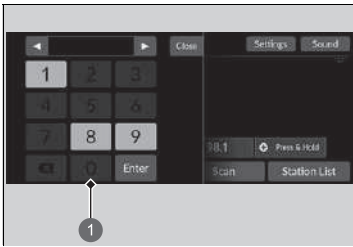

① On-screen Keyboard

1. Select **Tune**.

2. Enter the desired radio frequency using the on-screen keyboard.

3. Select **Enter** to tune into the frequency.

☒ Radio Frequency Manual Tune Screen

You can tune the range of FM frequency between 87.5 to 108.0MHz.

◀▶ icons:

Select ◀ or ▶ to tune the radio frequency.

■ Radio Data System (RDS)

Provides text data information related to your selected RDS-capable FM station.

■ To find an RDS station from Station List

1. Select **Station List** to display a list while listening to an FM station.
2. Select the station.

■ Manual update

Updates your available station list at any time.

1. Select **Station List** to display a list while listening to an FM station.
2. Select **Refresh**.

■ Traffic announcement (TA)

The TA standby function allows the system to stand by for traffic announcements in any mode while the function is on. The last tuned station must be an RDS capable traffic program station.

To turn the function on: Select **TA**. When a traffic announcement begins, the information screen appears on the audio/information screen. The system returns to your last selected mode after the traffic announcement is finished.

- If you want to go back to your last selected mode during the traffic announcement, select **Stop**.

To turn the function off: Select **TA** again.

☒ Radio Data System (RDS)

When you select an RDS-capable FM station, the RDS automatically turns on, and the frequency display changes to the station name. However, when the signals of that station become weak, the display changes from the station name to the frequency.

☒ Traffic announcement (TA)

The **TA** indicator appears on the header area while the TA standby function is on.

If you select **Scan** while the TA standby function is on, the system searches TP station only.

Selecting **TA** while the traffic announcement is on does not cancel the TA standby function.

Settings

Changes the RDS settings.

1. Settings.

2. Select an option.

- **TA-Information:** Turns on and off the traffic information. (**ON/OFF***1)
- **AF:** Turns on and off to automatically change the frequency of the same program you enter different regions. (**ON***1/**OFF**)
- **REG:** Turns on and off to keep the same stations within that region even if the signal gets weak. (**ON***1/**OFF**)
- **NEWS:** Turns on and off to automatically to tune to the news program. (**ON/OFF***1)

*1: Default Setting

Playing DAB (Digital Audio Broadcasting)

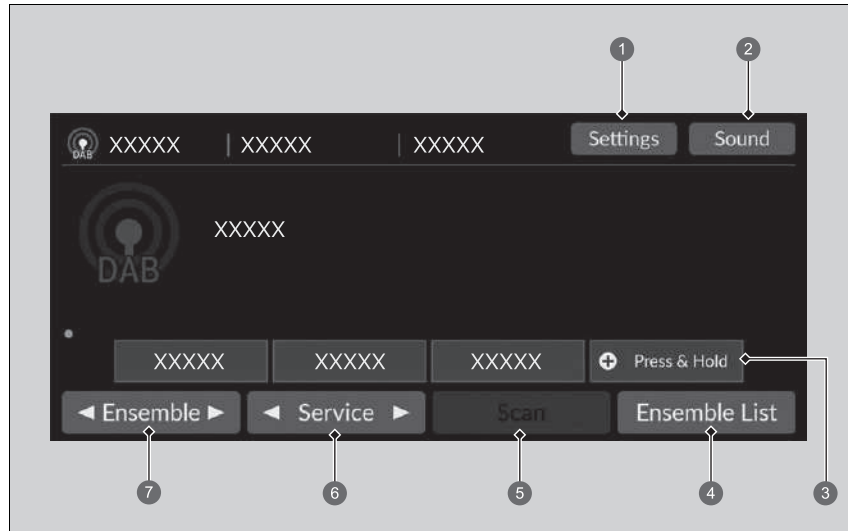

- ① Settings Icon
- ② Sound Icon
- ③ Preset Icons
- ④ Ensemble List Icon
- ⑤ Scan Icon
- ⑥ Service Icons
- ⑦ Ensemble Icons

■ Preset Memory

Tunes the preset frequency.

To store a service:

1. Tune to the selected service.
2. Select and hold the preset icon to store that station.
 - ▶ Selecting **Press & Hold** can be set a new preset station.

■ Ensemble List

Lists the receivable ensembles on the selected service.

1. Select **Ensemble List** to display a list.
2. Select the ensemble.

■ Manual update

Updates your available ensemble list at any time.

1. Select **Ensemble List** to display a list.
2. Select **Refresh**.

■ Ensemble

Tunes the ensemble.

1. Select ◀ to ▶ the tune ensemble.
2. Select and hold ◀ or ▶ to search the selected service up to down for an ensemble until a receivable ensemble is found.

■ Service

Tunes the service component.

To tune it, select ◀ or ▶.

▶▶ Preset Memory

Switching the Audio Mode

Roll up or down to select  (audio) on the left selector wheel.

▶▶ **Audio Remote Controls** P. 261

You can store 12 DAB stations into preset memory.

■ Scan

Samples each of the receivable ensemble or service on the selected service for 10 seconds.

To begin scanning, select **Scan**, and to turn it off, select **Cancel** or **⏮**.

■ Sound

Adjusts the sound settings.

➤ **Adjusting the Sound** P. 276

■ Settings

Changes the DAB settings.

- 1. Settings.**
2. Select the option you want to change.

Playing an iPod

Using your USB connector, connect the iPod to the USB port, then select the USB mode.

➤ **USB Ports** P. 259

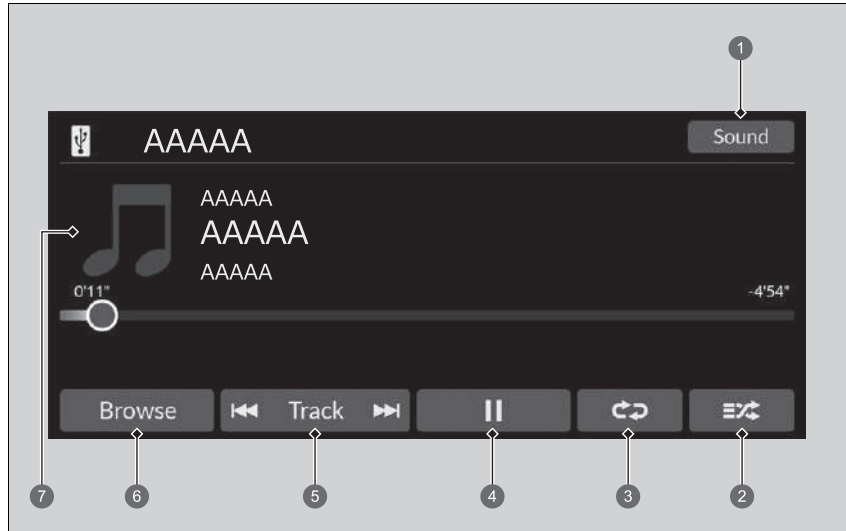

- ➊ Sound Icon
- ➋ Shuffle Icon
- ➌ Repeat Icon
- ➍ Play/Pause Icon

- ➎ Track Icons
- ➏ Browse Icon
- ➐ Cover Art

▶▶ Playing an iPod

Available operating functions vary on models or versions. Some functions may not be available on the vehicle's audio system.

If there is a problem, you may see an error message on the audio/information screen.

➤ **iPod/USB Flash Drive** P. 357

If you operate the music app on your iPhone/iPod while the phone is connected to the audio system, you may no longer be able to operate the same app on the audio/information screen. Reconnect the device if necessary.

If a smartphone is connected via Apple CarPlay or Android Auto, the iPod/USB source will be unavailable and audio files on the phone will be playable only within Apple CarPlay or Android Auto.

■ How to Select a Song from the Music Search List

You can select to display the music search list screen.

1. Select **Browse**.
2. Select a search category.
3. Continue making selections until you find the song of your choice.

■ How to Select a Play Mode

You can select shuffle and repeat modes when playing a song.

■ Shuffle/Repeat

Select shuffle or repeat icon repeatedly until a desired mode.

Shuffle

 (shuffle off): Shuffle mode to off.

 (shuffle all songs): Plays all available songs in a selected list in random order.

Repeat

 (repeat off): Repeat mode to off.



 (repeat song): Repeats the current song.

 (repeat all): Repeats the all songs.

■ To pause or resume a song

Select the play/pause icon.

■ How to Change a Song

You can select  or  to change songs. Select and hold to move rapidly within a song.

■ Sound

You can adjust the sound settings.

➤ **Adjusting the Sound** P. 276

Playing a USB Flash Drive

Your audio system reads and plays sound and video files on a USB flash drive. Connect your USB flash drive to the USB port, then select the USB mode.

➔ **USB Ports** P. 259

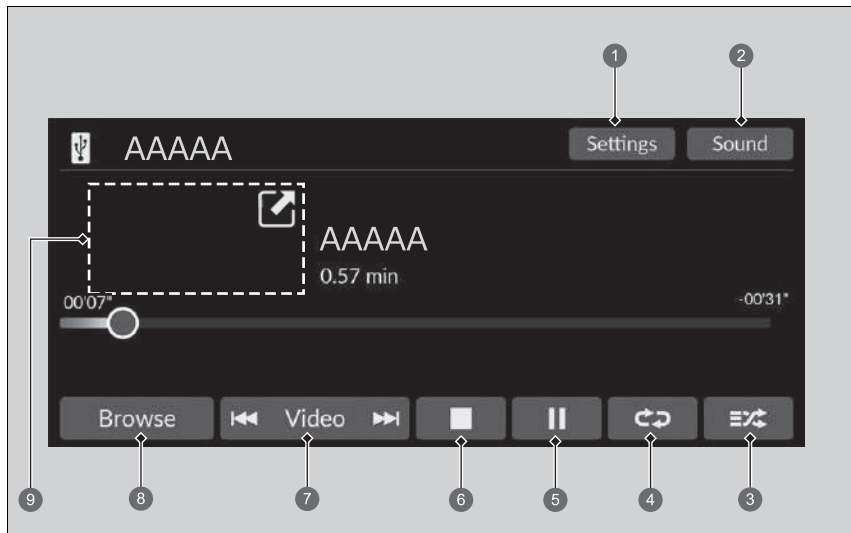

- ① **Settings Icon***
- ② **Sound Icon**
- ③ **Random Icon**
- ④ **Repeat Icon**
- ⑤ **Play/Pause Icon**
- ⑥ **Stop Icon***
- ⑦ **Track*/Video* Icons**
- ⑧ **Browse Icon**
- ⑨ **Cover Art* (Playing a music)/ Mini Player* (Playing a video)**

▶▶ Playing a USB Flash Drive

You can use the following formats to play sound or video files on a USB flash drive.

When playing a sound file: MP3, WMA, AAC*, FLAC, PCM/WAVE

When playing a video file: MP4, AVI, MKV, ASF/WMV

*1: Only AAC format files recorded with iTunes are playable on this unit.

■ How to Select a File from the Music Search List

You can select to display the music search list screen.

1. Select **Browse**.
2. Select **Current Playlist, Music, or Video**.
3. Continue making selections until you find the file or video of your choice.

⌘▶▶ Playing a USB Flash Drive

Use the recommended USB flash drives.

▶▶ **General Information on the Audio System**

P. 358

WMA and AAC files protected by digital rights management (DRM) cannot be played.

The audio system displays **Unplayable File**, then skips to the next file.

If there is a problem, you may see an error message on the audio/information screen.

▶▶ **iPod/USB Flash Drive** P. 357

■ How to Select a Play Mode

You can select repeat and random modes when playing a file.

■ Random/Repeat

Select random or repeat icon repeatedly until a desired mode.

Random

 (random off): Random mode to off.

 (random all files): Plays all files in random order.

 (random in folder): Plays all files in the current folder in random order.

Repeat

 (repeat off): Repeat mode to off.

 (repeat file): Repeats the current file.

 (repeat folder): Repeats all files in the current folder.

■ When playing a video file*

 (stop): Select to stop a file.

 / : Select  to shrink a video screen. Select  to expand a video screen.

■ To pause or resume a file

Select the play/pause icon.

■ How to Change a File

Track*/Video* Icons

You can select to change files. Select and hold to move rapidly within a file.

■ Sound

You can adjust the sound settings.

📖 **Adjusting the Sound** P. 276

■ Settings

Changes the USB settings when playing a video file.

1. Settings.

2. Select an option.

- **Image Settings:** Changes the brightness of the audio/information screen. To reset the settings, select **Default**. (**Brightness/Contrast/Black Level/Colour/Tint**).
- **Aspect Ratio:** Selects the display mode with a different aspect ratio. (**Original/Normal*¹/Full/Zoom**)
- **Overlay Clock Location:** Changes the clock display layout. (**Upper right*¹/Upper left/Lower right/Lower left/OFF**)
- **Screen Size:** Changes the screen size. (**Normal*¹/Large**)

*1: Default Setting

Playing *Bluetooth*® Audio

Your audio system allows you to listen to music from your *Bluetooth*-compatible phone.

This function is available when the phone is paired and connected to the vehicle's Hands-Free Telephone (HFT) system.

➤ **Phone Setup** P. 346

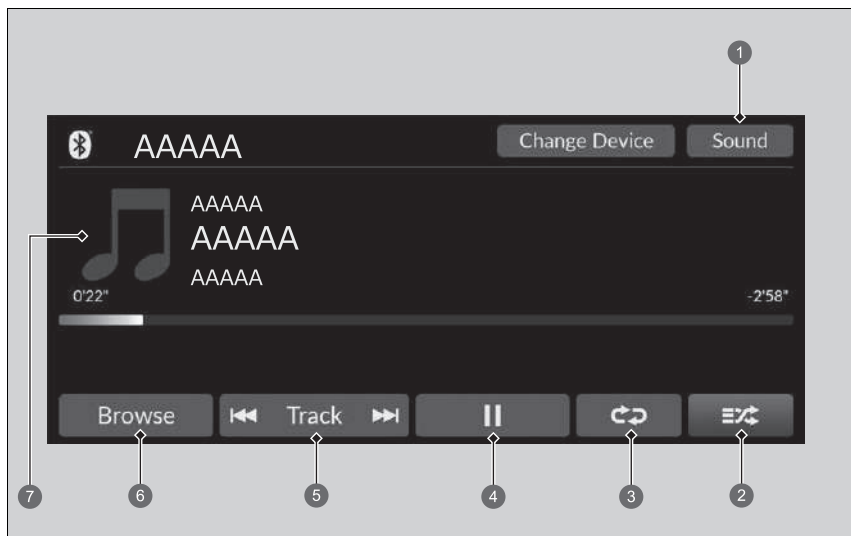

1 Sound Icon

2 Shuffle Icon

3 Repeat Icon

4 Play/Pause Icon

5 Track Icons

6 Browse Icon

7 Cover Art

▶▶ Playing *Bluetooth*® Audio

Not all *Bluetooth*-enabled phones with streaming audio capabilities are compatible. To check if your phone is compatible, ask a dealer.

It may be illegal to perform some data device functions while driving.

Only one phone can be used with HFT at a time. When there are more than two paired phones in the vehicle, the latest paired phone the system finds is automatically connected.

If more than one phone is paired to the HFT system, there may be a delay before the system begins to play.

In some cases, the name of the artist, album, or track may not appear correctly.

Some functions may not be available on some devices.

If a phone is currently connected via Apple CarPlay or Android Auto, *Bluetooth*® Audio from that phone will be unavailable. However, if the other phone is connected to the system, it can be used as *Bluetooth*® Audio by selecting the audio mode.

➤ **Phone Setup** P. 346

■ To Play *Bluetooth*® Audio Files

1. Make sure that your phone is paired and connected to the system.
 **Phone Setup** P. 346
2. Select the *Bluetooth*® Audio mode.

If the phone is not recognised, another HFT-compatible phone, which is not compatible for *Bluetooth*® Audio, may already be connected.

■ How to Select a Play Mode

You can select shuffle and repeat modes when playing a song.

Shuffle

 (shuffle off): Shuffle mode to off.

 (shuffle all songs): Plays all available songs in a selected list in random order.

Repeat

 (repeat off): Repeat mode to off.

 (repeat song): Repeats the current song.

 (repeat all): Repeats the all songs.

■ To pause or resume a file

Select the play/pause icon.

■ Searching for Music

1. Select **Browse**.
2. Select a search category.
3. Select an item.
 ▶ The selection begins playing.

▶▶ To Play *Bluetooth*® Audio Files

To play the audio files, you may need to operate your phone. If so, follow the phone maker's operating instructions.

Switching to another mode pauses the music playing from your phone.

You can change the connected phone by selecting **Change Device**.

 **Phone Setup** P. 346

▶▶ Searching for Music

Depending on the *Bluetooth*® device you connect, some or all of the lists may not be displayed.

■ Sound

You can adjust the sound settings.

▶ **Adjusting the Sound** P. 276

Playing a Video Using the HDMI™

Your audio system allows you to play videos from an HDMI-compatible device. Connect the device, using an HDMI™ cable, then select the HDMI™ mode.

▶ **HDMI™ Port** P. 260

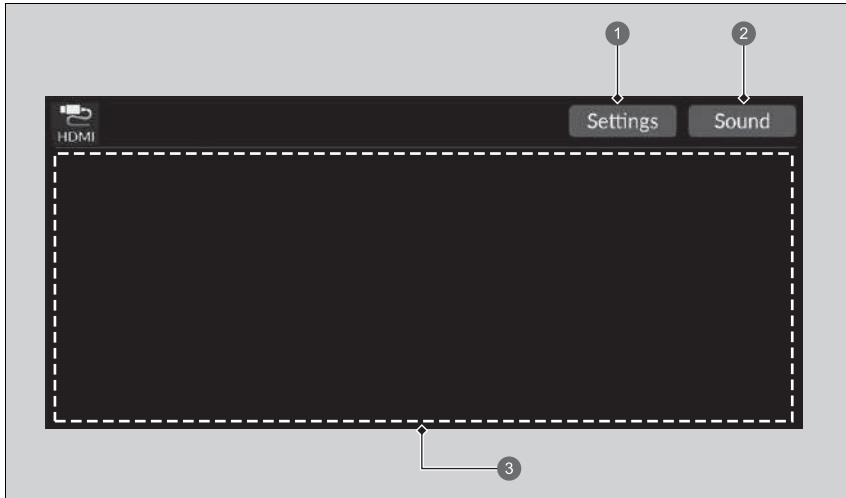

- 1 Settings Icon
- 2 Sound Icon
- 3 Displays playing video

▶▶ Playing a Video Using the HDMI™

This feature is limited while driving. To play videos, stop your vehicle and apply the parking brake.

■ Sound

You can adjust the sound settings.

🔍 **Adjusting the Sound** P. 276

■ Settings

Changes the HDMI settings.

1. Settings.

2. Select an option.

- **HDMI Image Settings:** Changes the brightness of the audio/information screen. To reset the settings, select **Default**.
- **Aspect Ratio:** Selects the display mode with a different aspect ratio. (**Normal/Full*1/Zoom**)
- **Overlay Clock Location:** Changes the clock display layout. (**Upper right*1/Upper left/Lower right/Lower left/OFF**)
- **Screen Size:** Changes the screen size. (**Normal*1/Full**)

🔍 Settings

If the header area and icons are not displayed while the video is playing on the full screen, touch the audio/information screen.

*1: Default Setting

Wi-Fi Connection

You can connect the audio system to the Internet using Wi-Fi on the audio/information screen. If your phone has wireless hotspot capabilities, the system can be tethered to the phone. Use the following steps to setup.

Connecting to a Wi-Fi Hotspot

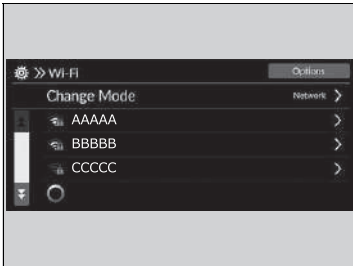

1. Select **General Settings**.
2. Select **Connections**.
3. Select **Wi-Fi**.
4. Select **OK**.
5. Select **Change Mode**.
6. Select **Network**.
 - ▶ If the data sharing settings is to **OFF**, the message will be displayed on the screen. You need to change to **ON**.
 - ▶ **System** P. 324
 - ▶ If you want to turn off the Wi-Fi mode, select **OFF**.
7. Select the access point you want to connect to the system.
 - ▶ To add a new network or select the saved networks, select **Options**.
 - ▶ If **Options** is selected, **Add Network** and **Saved Networks** can be registered.

Wi-Fi Connection

Wi-Fi and Wi-Fi Direct a registered trademark of Wi-Fi Alliance®.



Connecting to a Wi-Fi Hotspot

You cannot go through the setting procedure while a vehicle is moving. Park in a safe place to set the audio system in Wi-Fi mode.

Some mobile phone carriers charge for tethering and smartphone data use. Check your phone's data subscription package.

Check your phone manual to find out if the phone has Wi-Fi connectivity.

You can confirm whether Wi-Fi connection is on or off with the  icon on the system status area. Transmission speed and others will not be displayed on this screen.

▶ **Status Area** P. 270

In case of Wi-Fi connection with your phone, make sure your phone's Wi-Fi setting is in access point (tethering) mode.

Continued

■ Wi-Fi mode (after the initial setting has been made)

Make sure your phone's Wi-Fi setting is in access point (tethering) mode.

■ Setting the Audio System as a Wi-Fi Hotspot

You can set the network as a Wi-Fi Hotspot of this audio system.

Use the following steps to setup.

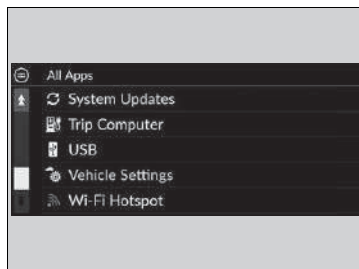

1. Select  **All Apps** and then select **Wi-Fi Hotspot**.
2. Turn on the hotspot.
3. Select **Settings**.
 - ▶ **Network SSID** and **Password** are displayed, and you can change the settings.

The following settings are available for the setup.

- **Network SSID:** Set this network name.
- **Password:** Set password for require entering password when connecting Wi-Fi device to this network.
 - ▶ Passwords can be created with half-width alphanumeric characters and some special characters.

▶▶ Wi-Fi mode (after the initial setting has been made)

iPhone users

You may need to go through an initial setup for Wi-Fi connection again after you boot your phone.

▶▶ Setting the Audio System as a Wi-Fi Hotspot

Special characters that can be used in passwords.

!)	;]
"	*	<	^
#	+	=	-
\$,	>	`
%	-	?	{
&	.	@	
'	/	[}
(:	~	

Apple CarPlay

If you connect an Apple CarPlay-compatible iPhone to the system via the USB port or wirelessly, you can use the audio/information screen, instead of the iPhone display, to make a phone call, listen to music, view maps (navigation), and access messages.

📌 **USB Ports** P. 259



1 Apple CarPlay

📌 Apple CarPlay

Only iPhone 5 or newer versions with iOS 8.4 or later are compatible with Apple CarPlay.

Park in a safe place before connecting your iPhone to Apple CarPlay and when launching any compatible apps.

While connected to Apple CarPlay, calls are only made through Apple CarPlay. If you want to make a call with the Hands-Free Telephone (HFT) system, turn Apple CarPlay off.

📌 **Setting Up Apple CarPlay** P. 307

When your iPhone is connected to Apple CarPlay, it is not possible to use the *Bluetooth*® Audio or the Hands-Free Telephone (HFT) system. However, other previously paired phones can stream audio via *Bluetooth*® while Apple CarPlay is connected.

📌 **Phone Setup** P. 346

For details on countries and regions where Apple CarPlay is available, as well as information pertaining to function, refer to the Apple homepage.

■ Apple CarPlay Menu

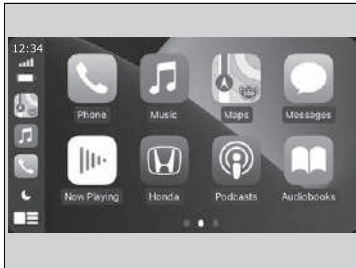

- **Phone**
Access the contact list, make phone calls, or listen to voice mail.
- **Music**
Play music stored on your iPhone.
- **Maps**
Display Apple Maps and use the navigation function just as you would on your iPhone.
- **Messages**
Check and reply to text messages, or have messages read to you.
- **Honda**
Select the Honda icon to go back to the home screen.
- 
Go back to the Apple CarPlay menu screen.

» Apple CarPlay

Apple CarPlay Operating Requirements & Limitations

Apple CarPlay requires a compatible iPhone with an active mobile connection and data plan. Your carrier's rate plans will apply.

Changes in operating systems, hardware, software, and other technology integral to providing Apple CarPlay functionality, as well as new or revised governmental regulations, may result in a decrease or cessation of Apple CarPlay functionality and services. Honda cannot and does not provide any warranty or guarantee of future Apple CarPlay performance or functionality.

It is possible to use 3rd party apps if they are compatible with Apple CarPlay. Refer to the Apple homepage for information on compatible apps.

■ Setting Up Apple CarPlay

After you have connected your iPhone to the system via the USB port or wirelessly, use the following procedure to set up Apple CarPlay. Use of Apple CarPlay will result in the transmission of certain user and vehicle information (such as vehicle location, speed, and status) to your iPhone to enhance the Apple CarPlay experience. You will need to consent to the sharing of this information on the audio/information screen.

■ Enabling Apple CarPlay

■ Connecting Apple CarPlay using the USB cable to the USB port

1. Connect the iPhone to the USB port using the USB cable.

📄 **USB Ports** P. 259

▶ The confirmation screen will be displayed.

2. Select **Yes**.

▶ If you do not want to connect Apple CarPlay, select **No**.

You may change the consent settings under the **Smartphone Connection** settings menu.

■ Connect Apple CarPlay wirelessly

1. Pair and connect the iPhone to the vehicle's Hands-Free Telephone (HFT) system.

📄 **Phone Setup** P. 346

2. Check the box on **Apple CarPlay**.

▶ If you select **Apple CarPlay**, you cannot select **Audio** and **Phone**.

3. Select **Connect**.

▶ If your iPhone asks to accept for connecting Apple CarPlay, accept for connection.

☒ Setting Up Apple CarPlay

You can also use the method below to set up Apple CarPlay:

Select **General Settings** → **Smartphone Connection** → **Apple CarPlay** → **Select device**

Use of user and vehicle information

The use and handling of user and vehicle information transmitted to/from your iPhone by Apple CarPlay is governed by the Apple iOS terms and conditions and Apple's Privacy Policy.

■ Operating Apple CarPlay with Siri

Press and hold the  (talk) button to activate Siri.

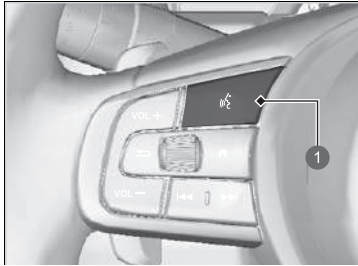

① (Talk) Button

Press and hold to activate Siri.

Press again to deactivate Siri.

Press and release to activate standard voice recognition system.

▣ Operating Apple CarPlay with Siri

Below are examples of questions and commands for Siri:

- What movies are playing today?
- Call dad at work.
- What song is this?
- How's the weather tomorrow?
- Read my latest email.

For more information, please visit www.apple.com/ios/siri.

Android Auto™

When you connect an Android phone to the audio system via the USB port, Android Auto is automatically initiated. When connected via Android Auto, you can use the audio/information screen to access the Phone, Google Maps (Navigation), Google Play Music, and Google Now functions. When you first use Android Auto, a tutorial will appear on the screen.

We recommend that you complete this tutorial while safely parked before using Android Auto.

➤ **USB Ports** P. 259

➤ **Auto Pairing Connection** P. 311



1 Android Auto

Android Auto™

Only Android 5.0 (Lollipop) or later versions are compatible with Android Auto. *Bluetooth* A2DP cannot be used with Android Auto phone.

To use Android Auto on a smartphone with Android 9.0 (Pie) or earlier, you need to download the Android Auto app from Google Play to your smartphone.

Park in a safe place before connecting your Android phone to Android Auto and when launching any compatible apps.

To use Android Auto, connect the USB cable to the USB port.

➤ **USB Ports** P. 259



When your Android phone is connected to Android Auto, it is not possible to use the *Bluetooth*® Audio. However, other previously paired phones can stream audio via *Bluetooth*® while Android Auto is connected.

➤ **Phone Setup** P. 346

Android Auto is a trademark of Google LLC.

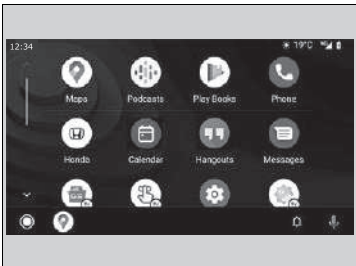
Android Auto Menu



- **Maps**
Display Google Maps and use the navigation function just as you would with your Android phone. When the vehicle is in motion, it is not possible to make keyboard entries. Stop the vehicle in a safe location to undertake a search or provide other inputs.
- **Phone**
Make and receive phone calls as well as listen to voicemail.
- **Honda**
-  Operate Android Auto with your voice.
-  You can check Android notifications.
-  (Android Auto Home)
Display useful information organised by Android Auto into simple cards that appear just when they're needed.

Android Auto™

For details on countries and regions where Android Auto is available, as well as information pertaining to function, refer to the Android Auto homepage.

Android Auto Operating Requirements & Limitations

Android Auto requires a compatible Android phone with an active mobile connection and data plan. Your carrier's rate plans will apply.

Changes in operating systems, hardware, software, and other technology integral to providing Android Auto functionality, as well as new or revised governmental regulations, may result in a decrease or cessation of Android Auto functionality and services. Honda cannot and does not provide any warranty or guarantee of future Android Auto performance or functionality.

It is possible to use 3rd party apps if they are compatible with Android Auto. Refer to the Android Auto homepage for information on compatible apps.

■ Auto Pairing Connection

When you connect an Android phone to the unit via the USB port, Android Auto is automatically initiated.

■ Enabling Android Auto

To enable Android Auto after connecting an Android phone to the system, select **Yes** on the screen.

You may change the consent settings under the **Smartphone Connection** settings menu.

☒ Enabling Android Auto

Only initialize Android Auto when you safely parked. When Android Auto first detects your phone, you will need to set up your phone so that auto pairing is possible. Refer to the instruction manual that came with your phone.

You can use the method below to change Android Auto settings after you have completed the initial setup:

Select General Settings → Smartphone Connection → Android Auto → Select device

Use of user and vehicle information

The use and handling of user and vehicle information transmitted to/from your phone by Android Auto is governed by the Google's Privacy Policy.

Continued

■ Operating Android Auto with Voice Recognition

Press and hold the  (talk) button to operate Android Auto with your voice.

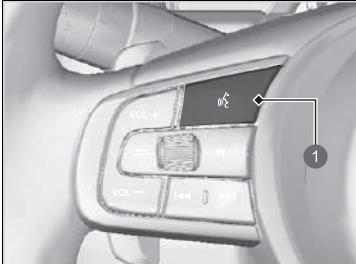

① (Talk) Button

Press and hold to operate Android Auto with your voice.
Press and release to activate standard voice recognition system.

▶▶ Operating Android Auto with Voice Recognition

Below are examples of commands you can give with voice recognition:

- Reply to text.
- Call my wife.
- Navigate to Honda.
- Play my music.
- Send a text message to my wife.
- Call flower shop.

For more information, please refer to the Android Auto homepage.

You can also activate the voice recognition function by selecting the  icon in the lower-left corner of the screen.

Power Flow

The energy flow screen shows the vehicle's power flow, average energy consumption, range, and climate control system ON/OFF indicator.

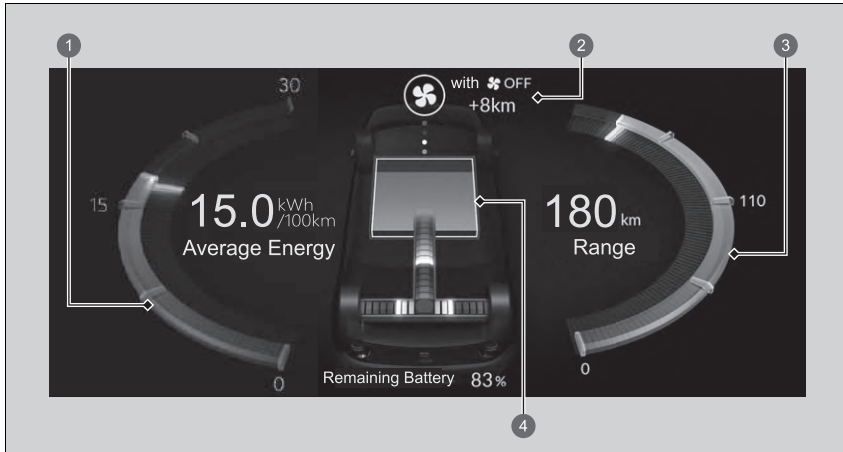



- ❶ Average Energy Consumption
- ❷ Climate Control System ON/OFF Indicator
- **Additional Driving Range** P. 316
- ❸ Driving Range by High Voltage Battery
- ❹ High Voltage Battery Level Gauge



Shows the High Voltage battery power flow, indicating what is supplying power to the vehicle and/or charging the battery.

- ▶ The indicator for the power transmission appears in blue, and for the battery charging operation, in green.

When the shift position is set to D

Display	Colour of indicators	Vehicle's Condition
	Blue	While Driving: Power is being supplied by the High Voltage battery.
	Green	While Decelerating: High Voltage battery is being charged by regenerative braking.
	—	When Stopped: The vehicle is idle (standby state).

When the shift position is set to P

Display	Colour of indicators	Vehicle's Condition
 <p>Charging</p>	Blue	Power to the climate control system and/or the power outlet is being supplied by the High Voltage battery.
 <p>Charging</p>	Green	High Voltage battery is being charged by an AC or CCS2 DC charger.

■ Additional Driving Range

Shows the estimated distance you can travel on the remaining power. This estimate is based on the energy consumption of your previous trips and the remaining charge of the high voltage battery.

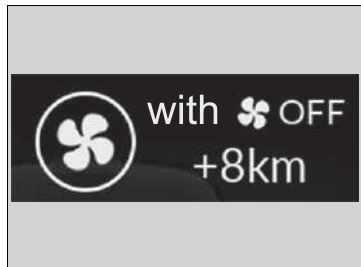

You can increase the driving range by turning off the climate control system. The distance displayed under **with  OFF** is the additional estimated distance that the vehicle can drive if the climate control system is turned off.

To turn the climate control system off, press the  button.

➤ **Climate Control System** P. 246

▣ Additional Driving Range

The additional driving range displayed is only an estimate and may differ to the actual distance the vehicle can travel.

Driving range is dependent on driving conditions and climate control system use. Since the climate control system in this vehicle runs on electricity, it will consume electricity when in use. The climate control system requires more electricity for heating than it does for cooling; therefore, when you use the heating function, especially when ambient temperatures are very low, the distance that you can travel on the remaining power will be shortened. The audio/information screen shows the driving range as well as the amount of electricity that has been consumed by the motor and the climate control system.

EV Menu

The several settings for the EV mode on the **EV Menu** screen. Select **EV Menu** on the shortcut area.

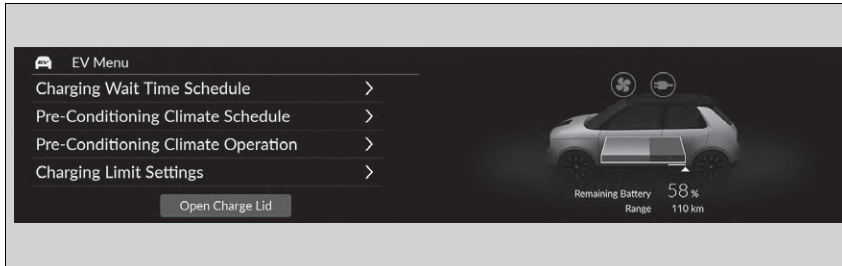

The following items can be set.

- Charging Wait Time Schedule
- Pre-Conditioning Climate Schedule
- Pre-Conditioning Climate Operation
- Charging Limit Settings

Press and hold **Open Charge Lid** to open the charge lid.

- ✎ **Charge the High Voltage battery using a AC or CCS2 DC charger** P. 557

■ Charging Wait Time Schedule Setting

Charging wait time schedule can be set.

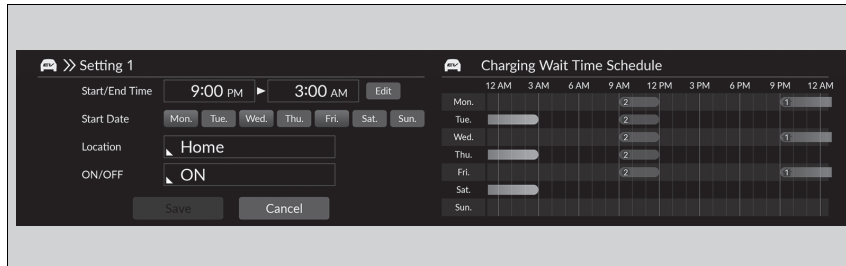

1. Select a desired settings.
 - ▶ ① shows the time for **Home**, ② shows the time for **Anywhere**.
2. Select **Save**.
 - ▶ If the function is **ON**, it will be light blue; if **OFF**, it will be gray.

▶▶ Charging Wait Time Schedule Setting

If the Home Location is not set in the Navigation system, it will default to **Anywhere**.

For detail information for charging wait time schedule setting, refer to the following page.

▶ **Using a Timer P. 563**

Pre-Conditioning Climate Schedule Setting

Pre-conditioning climate schedule can be set.

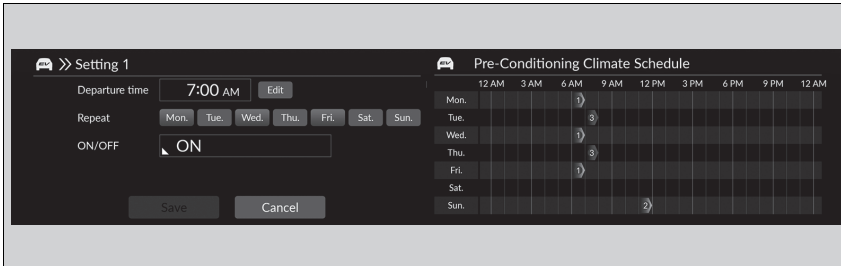

1. Select a desired settings.
2. Select **Save**.
 - ▶ It is possible to set the Pre-conditioning climate schedule from **Setting 1** to **Setting 7**.

Pre-Conditioning Climate Schedule Setting

Pre-Conditioning Climate can only operate for up to 30 minutes. A new schedule cannot be set if there is another valid schedule within those 30 minutes.

■ Pre-Conditioning Climate Operation Setting

Pre-conditioning climate operation can be set.

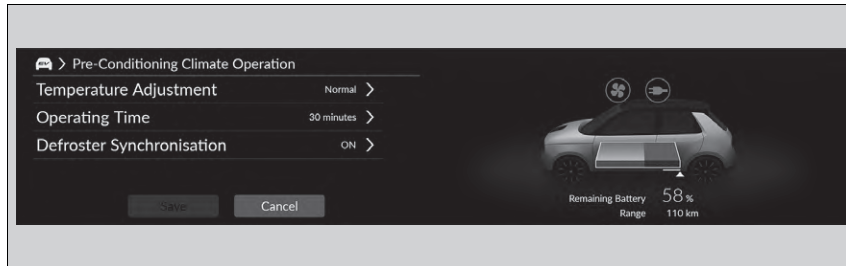

1. Select a desired settings.
2. Select **Save**.

The following items can be set.

- **Temperature Adjustment:** Selects the temperature adjustment of the remote climate pre-conditioning. (**Colder/Normal*¹/Warmer**)
- **Operating Time:** Selects operating time of the remote climate pre-conditioning. (**10 minutes/20 minutes/30 minutes*¹**)
- **Defroster Synchronisation:** The On/Off settings for operating the defroster automatically. (**ON*¹/OFF**)

*1: Default Setting

☞ Pre-Conditioning Climate Operation Setting

This setting is possible when the climate control system has been activated by the keyless remote.

☑ **Remote Climate Pre-Conditioning** P. 249

■ Charging Limit Settings

Charging limit can be set.



1. Select a desired settings.
2. Select **Save**.

☒ Charging Limit Settings

If the Home Location is not set in the Navigation system, it will default to **Away**.

Driver Assist System On and Off

The Driver Assist System functions can be set to On/Off on the **Safety Config** screen. Select **Safety Config** on the audio/information screen, and then select each function icon to change the settings.

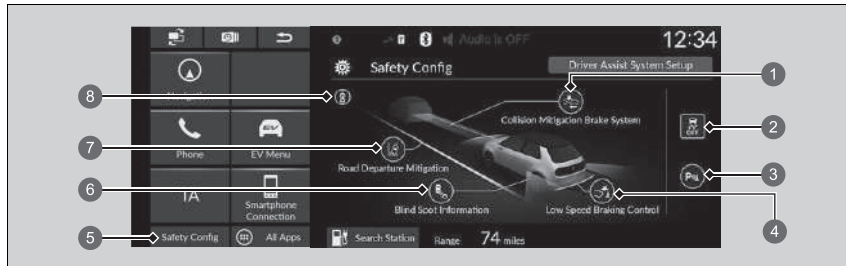

- 1 **Collision Mitigation Brake System** Icon green (On)/gray (Off)
- 2 **VSA OFF** Icon green (On)/amber (Off)
- 3 **Parking Sensor** Icon green (On)/gray (Off)
- 4 **Low Speed Braking Control** Icon green (On)/gray (Off)
- 5 **Safety Config** Icon
- 6 **Blind Spot Information** Icon green (On)/gray (Off)
- 7 **Road Departure Mitigation** Icon green (On)/gray (Off)
- 8 **Safety Support Indicator**

▶▶ Driver Assist System On and Off

If there is a problem with any of the functions below, the applicable icon/indicator will come on in amber. If this happens, have your vehicle checked by a dealer.

- 1 **Collision Mitigation Brake System** Icon
- 3 **Parking Sensor** Icon
- 4 **Low Speed Braking Control** Icon
- 6 **Blind Spot Information** Icon
- 7 **Road Departure Mitigation** Icon
- 8 **Safety Support Indicator**

If there is a problem with the function below, the icon will come on in gray.

If this happens, have your vehicle checked by a dealer.

- 2 **VSA OFF** Icon

Customized Features

Use the audio/information screen to customize certain features.

How to Customize the General Settings

With the power mode in ON, select **General Settings**, then select a setting item.

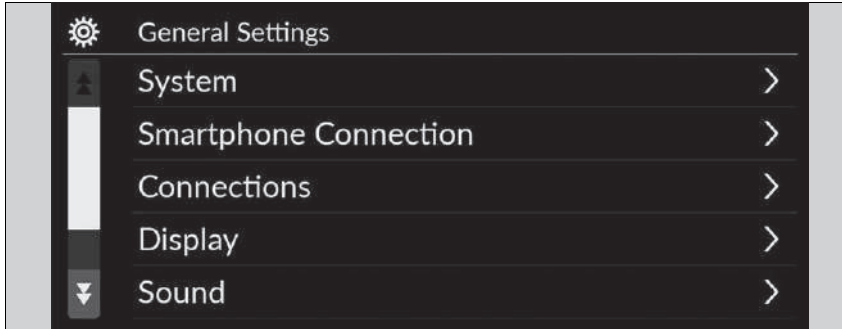

- **System** ➤ P. 324
- **Smartphone Connection** ➤ P. 326
- **Connections** ➤ P. 327
- **Display** ➤ P. 328
- **Sound** ➤ P. 329
- **Camera** ➤ P. 330
- **Voice Control** ➤ P. 330

Customized Features

When you customize settings:

- Make sure that the vehicle is at a complete stop.
- Put the transmission into [P].





■ System

Customizable Features		Description	Selectable Settings	
Date & Time	Set Date & Time	Automatic Date & Time	Selects ON to have the GPS automatically adjust the clock. Select OFF to cancel this function.	ON^{*1}/OFF
		Set Date	Adjusts date. ▶ Adjusting the Clock P. 273	Day/Month/Year
		Set Time	Adjusts time. ▶ Adjusting the Clock P. 273	Hour/Minute AM/PM
	Time Zone	Automatic Time Zone	Sets the audio system to automatically adjust the clock when driving through different time zones.	ON^{*1}/OFF
		(Select time zone)	Changes the time zone manually.	—
	Auto Daylight Saving Time	Sets the clock to update based on daylight savings time.	ON^{*1}/OFF	
	Date Format	Select a date format.	MM/DD/YYYY/ DD/MM/YYYY^{*1}/ YYYY/MM/DD	
	Time Format	Select a time format.	12-H^{*1}/24-H	

*1:Default Setting

Customizable Features	Description	Selectable Settings	
Language	Changes the driver information interface and audio/information screen language separately.	English ^{*1} See other selectable languages on the screen.	
Touch Panel Sensitivity	Sets the sensitivity of the touch panel screen.	High/Normal ^{*1}	
System Volumes	System Sounds	Sets the system sound volume level.	—
	Text-to-Speech	Sets the text-to-speech volume level.	—
	Navigation Guidance	Sets the navigation guidance volume level.	—
	Phone Calls	Sets the phone call volume level.	—
	Default	Resets all System Volumes settings to default values.	
Location and vehicle data sharing	Location and vehicle data sharing	ON/OFF ^{*1}	
Passenger App Launcher	Changes the shortcut launcher display on the passenger's side.	Auto/Always ^{*1} / Hide	

*1:Default Setting

Customizable Features		Description	Selectable Settings
About	Status	Displays the Android setting items.	—
	Legal Information		
	Model Number		
	Android Version		
	Kernel Version		
	Build Number		
Factory Data Reset		Resets all the settings to their factory default.  Defaulting All the Settings P. 338	Continue/Cancel
Detail Information	App Manager	Displays the Android system memory and apps information.	—
■ Smartphone Connection			
Customizable Features		Description	Selectable Settings
Apple CarPlay	+ Connect New Device	Pairs a new phone to Apple CarPlay.  Phone Setup P. 346	—
	(Saved Devices)	Connects, disconnects, or deletes a paired phone.  Phone Setup P. 346	—
Android Auto	(Saved Devices)	Connects, disconnects, or deletes a paired phone.  Phone Setup P. 346	—

■ Connections

	Customizable Features	Description	Selectable Settings	
Wi-Fi	Change Mode	Changes the Wi-Fi mode.	Network/ Smartphone^{*2}/OFF^{*1}	
	(Available Networks/Connected Devices)	Displays the available network(s) or current connected device(s).	—	
	Options	Add Network	Adds a new network to connect Wi-Fi.	—
		Saved Networks	Saves the connected network.	—
Bluetooth	Options	Bluetooth	Turns the <i>Bluetooth</i> [®] on and off.	ON^{*1}/OFF
		Priority Device	Sets a device as the priority device.	—
	+ Connect New Device	Pairs a new phone to HFT. 📱 Phone Setup P. 346	—	
	(Saved Devices)	Connects, disconnects, or deletes a paired phone. 📱 Phone Setup P. 346	—	

*1:Default Setting

*2:Appears only when Apple CarPlay is connected.

■ Display

Customizable Features	Description	Selectable Settings	
Image Quality Adjustment	Day Mode ^{*1}	Changes between the daytime mode and nighttime mode. ▶ Display Setup P. 277	—
	Night Mode		—
	Brightness	Changes the brightness of the centre screen.	—
	Contrast	Changes the contrast of the centre screen.	—
	Black Level	Changes the black level of the centre screen.	—
	Default	Resets all customized settings for the brightness, contrast, and black level.	—
Wallpaper	Adds, sets and deletes the wallpaper. ▶ Wallpaper Setup P. 271	—	

*1:Default Setting

■ Sound

Customizable Features	Description	Selectable Settings
<p>Bass / Treble</p> <p style="text-align: center;"> <u>Treble</u> <u>Midrange</u> <u>Bass</u> </p>	<p>Adjusts the settings of the audio speakers' sound. ▶ Adjusting the Sound P. 276</p>	<p>—</p>
<p>Balance / Fader</p>		
<p>Speed Volume Compensation</p>		
<p>Subwoofer Volume</p>		

■ **Camera**

Customizable Features		Description	Selectable Settings
Multi View Camera	Guidelines		
	Fixed Guideline	Shows the guideline that does not move with the steering wheel. ▶ Multi-View Camera P. 517	ON*¹/OFF
	Dynamic Guideline	Shows the guideline that moves with the steering wheel. ▶ Multi-View Camera P. 517	ON*¹/OFF
	Customise		
	Show after shifting from Reverse	Selects whether to display the forward camera image after shifting from R to D .	ON/OFF*¹
	Auto display when obstacle is detected	Displays the forward camera image when a parking sensor detects an obstacle.	ON*¹/OFF
	Cross Traffic Monitor	Shows arrows on the rear camera image to indicate vehicles approaching from the sides. ▶ Cross Traffic Monitor P. 513	ON*¹/OFF

*1:Default Setting

■ **Voice Control**

Customizable Features		Description	Selectable Settings
	Voice Control Mode	Selects a mode of the voice portal screen. ▶ Voice Control Operation P. 264	Assist/Normal*¹

*1:Default Setting

How to Customize the Vehicle Settings

With the power mode in ON, select **Vehicle Settings**, then select a setting item.



- **Deflation Warning System** ▶ P. 332
- **Driver Assist System Setup** ▶ P. 332
- **Meter setup** ▶ P. 334
- **Keyless Access Setup** ▶ P. 335
- **Lighting Setup** ▶ P. 336
- **Door/Window Setup** ▶ P. 337
- **Maintenance Info.** ▶ P. 337

▶▶ How to Customize the Vehicle Settings

If **Vehicle Settings** is not displayed on the shortcut area, select **All Apps**. You can change the displayed icons on the shortcut area.

▶ **App Shortcut Function** P. 269

It is possible to customize the vehicle settings from the image on the assistant screen.

Continued









■ Deflation Warning System

Customizable Features	Description	Selectable Settings
Deflation Warning System	Cancels/Calibrates Deflation Warning System. ► Deflation Warning System P. 418	Calibrate/Cancel

■ Driver Assist System Setup

Customizable Features	Description	Selectable Settings
Preceding vehicle proximity warning distance	Selects distance for Forward Collision Warning audible and visual alerts. ► Collision Mitigation Braking System (CMBS) P. 428	Far/Normal*¹/Near
ACC vehicle ahead detected beep	Turns On/Off audible notification when vehicle has moved in/out of adaptive cruise control range. ► Adaptive Cruise Control (ACC) with Low Speed Follow P. 445	ON/OFF*¹
ACC cut-in prediction control	Turns the ACC cut-in prediction control feature on and off. ► Intelligent Adaptive Cruise Control Function P. 462	ON*¹/OFF
Lead Car Departure Notification System	Changes the setting for the lead car departure notification system. ► Lead Car Departure Notification System P. 482	Normal*¹/Early/OFF
Road departure mitigation setting	Selects operating mode of the Road Departure Mitigation system. ► Road Departure Mitigation System P. 476	Early/Normal/Delayed*¹
Lane keep assist beep	Selects On/Off the LKAS alert for not detecting road lines. ► Lane Keeping Assist System (LKAS) P. 465	ON/OFF*¹

*1:Default Setting

Customizable Features	Description	Selectable Settings
Blind spot information	Selects On/Off the blind spot information system audible alert.  Blind spot information System P. 421	Audible and visual alert*¹/ Visual Alert Only
Traffic Sign Recognition System Display	Displays the traffic sign recognition system on the instrument panel.  Traffic Sign Recognition System P. 486	Display*¹/None
Traffic Sign Recognition System Speed Limit Warning	Enables over speed limit warning when speed limit is exceeded.  Traffic Sign Recognition System P. 486	ON*¹/OFF
Side Camera Mirror View	Selects the side camera mirror view.  Side Camera Mirror System P. 220	Wide/Normal*¹
Reference Line Display	Turns on/off the reference line display during indicator activation.  Reference Lines P. 223	ON with Indicator*¹/ON with Indicator + 2 Seconds/OFF
Reference Line Display (Reverse)	Turns on/off the reference line display while in [R] .  Reference Lines P. 223	ON*¹/OFF
Apply Parking Brake after Honda Parking Pilot	Automatically applies the parking brake at the completion of a Honda Parking Pilot manoeuvre.  Honda Parking Pilot P. 531	ON*¹/OFF
Honda Parking Pilot Space Detect Beep	Turns on/off the audible notification when Honda Parking Pilot detects an available parking space.  Honda Parking Pilot P. 531	ON*¹/OFF

*1:Default Setting

■ Meter setup

Customizable Features	Description	Selectable Settings
Warning message	Selects whether to display the warning message. ➤ Driver Information Interface Warning and Information Messages P. 130	ON/OFF^{*1}
Adjust outside temp. display	Selects to adjust outside temperature reading by a few degrees. ➤ Outside Temperature P. 155	-3°C ~ ±0°C^{*1} ~ +3°C
Trip A reset timing	Selects the timing to reset Trip A. ➤ Range / Energy Consumption / Trip Meter P. 158 ➤ Speed & Time P. 160	When charged/Manual reset^{*1}/ POWER OFF
Trip B reset timing	Selects the timing to reset Trip B. ➤ Range / Energy Consumption / Trip Meter P. 158 ➤ Speed & Time P. 160	When charged/Manual reset^{*1}/ POWER OFF
Alarm volume control	Changes volume level of all system warnings, door opening warning and indicator.	Max/Mid^{*1}/Min
Indicator tone	Selects the indicator tone.	Tone1^{*1}/Tone2/Tone3
Reverse position alert tone	Turns on/off the reverse alert sound.	ON^{*1}/OFF
Turn by turn display	Turns on/off the pop-up warning in the turn-by-turn navigation in the driver information interface. ➤ Turn-by-turn directions P. 162	ON^{*1}/OFF

*1:Default Setting

Customizable Features	Description	Selectable Settings
Speed/distance units	Selects the trip computer units. ➤ Unit Change P. 168	Left-hand drive type km/h · km^{*1}/mph · miles Right-hand drive type km/h · km/mph · miles^{*1}
Rear seat reminder	Turns on/off notifications when there may be an object in the rear seats. ➤ Driver Information Interface Warning and Information Messages P. 130	ON^{*1}/OFF

*1:Default Setting

■ **Keyless Access Setup**

Customizable Features	Description	Selectable Settings
Smart Entry Light Flash	Turns on/off the flash of the exterior lights when doors are unlocked/locked by holding or touching the sensor switch on outer door handles. ➤ Using the Keyless Access System P. 175	ON^{*1}/OFF
Auto Power ON/OFF	Turns on/off automatically in conjunction with bringing in and taking out the key. ➤ Auto Power ON/OFF P. 198	ON^{*1}/OFF

*1:Default Setting

■ Lighting Setup

Customizable Features	Description	Selectable Settings
Interior light dimmer duration	Selects the length of time the interior lights stay on after doors are closed. ➤ Interior Lights P. 234	60sec/30sec^{*1}/15sec
Headlight auto OFF timer	Selects the length of time the exterior lights stay on after you close the driver's door. ➤ Automatic Lighting Off Feature P. 203	60sec/30sec/15sec^{*1}/0sec
Headlight integration with wipers	Selects On/Off headlight function and wiper operation when the headlight is in AUTO setting. ➤ Headlight Integration with Wipers P. 203	ON^{*1}/OFF

*1:Default Setting

■ **Door/Window Setup**

Customizable Features	Description	Selectable Settings
The outer handle pop-out setting	Turns on/off to activate the custom settings on key fob for the outer handle auto pop-out function. 📄 Using the Keyless Access System P. 175	ON*¹/OFF
Keyless lock notification	Turns on/off flash of exterior lights when doors are locked/unlocked by remote. 📄 Using the Keyless Access System P. 175	ON*¹/OFF
Security relock timer	Selects relock timing after unlocking vehicle with the key fob without opening any doors. 📄 Using the Remote Transmitter P. 178	90sec/60sec/30sec*¹

*1:Default Setting

■ **Maintenance Info.***

Customizable Features	Description	Selectable Settings
Maintenance Info.	Resets the maintenance information. 📄 Service Reminder System * P. 576	Selects Reset Items

* Not available on all models

Defaulting All the Settings

Reset all the menu and customized settings as the factory defaults.

■ Defaulting General Settings

1. Select **General Settings**.
2. Select **System**.
3. Select **Factory Data Reset**.
 - A confirmation message appears on the screen.
4. Select **Continue** to reset the settings.
5. Select **Continue** again to reset the settings.
 - The system will reboot.

■ Defaulting Vehicle Settings

1. Select **Vehicle Settings**.
2. Select **Default**.
3. Select **Yes**.

» Defaulting All the Settings

When you transfer the vehicle to a third party, reset all settings to default and delete all personal data.



If you perform **Factory Data Reset**, it will reset the preinstalled apps to their factory default.

Hands-Free Telephone System

Hands-Free Telephone (HFT) system allows you to place and receive phone calls using your vehicle's audio system, without handling your mobile phone.

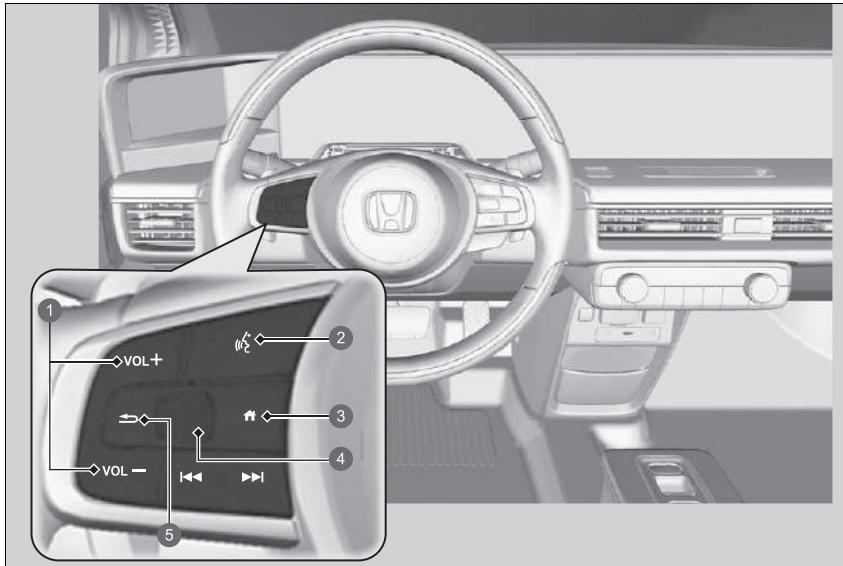
HFT Buttons



- 1 **VOL +** / **VOL -** (Volume) Buttons
- 2  (Talk) Button
- 3  (Home) Button
- 4 Left Selector Wheel
- 5  (Back) Button

Hands-Free Telephone System

Place your phone where you can get good reception.

To use HFT, you need a *Bluetooth*-compatible mobile phone. For a list of compatible phones, pairing procedures, and special feature capabilities, ask a dealer or your local Honda.

To use the system, the **Bluetooth** setting must be **ON**.

▶ **Phone Setup** P. 346

Voice control tips

- Aim the vents away from the ceiling and close the windows, as noise coming from them may interfere with the microphones.
- Press the  button when you want to call a number using a phonebook name or a number. Speak clearly and naturally after a beep.
- If the microphone picks up voices other than yours, the command may be misinterpreted.
- To change the volume level, select the audio system's **VOL** (Volume) or use the remote audio controls on the steering wheel.



If there is no Favourite contacts entry in the system, the pop-up notification appears on the screen.

▶ **Favourite Contacts** P. 351

Continued

 **(Talk) button:** Press to access Voice Portal.

 **(Home) button:** Press to go back to the home screen of the driver information interface.

Left Selector Wheel: Press the  (home) button, then roll up or down to select  (phone) on the driver information interface, and then press the left selector wheel.

While receiving a call, the incoming call screen is displayed on the driver information interface. You can pick up the call using the left selector wheel.

 **Receiving a Call** P. 355

 **(Back) button:** Press to go back to the previous screen or cancel a command.

Hands-Free Telephone System

Bluetooth[®] Wireless Technology

The *Bluetooth*[®] word mark and logos are registered trademarks owned by *Bluetooth* SIG, Inc., and any use of such marks by Honda Motor Co., Ltd., is under licence. Other trademarks and trade names are those of their respective owners.

HFT Limitations

An incoming call on HFT will interrupt the audio system when it is playing. It will resume when the call is ended.

■ HFT Status Display

The audio/information screen notifies you when there is an incoming call.

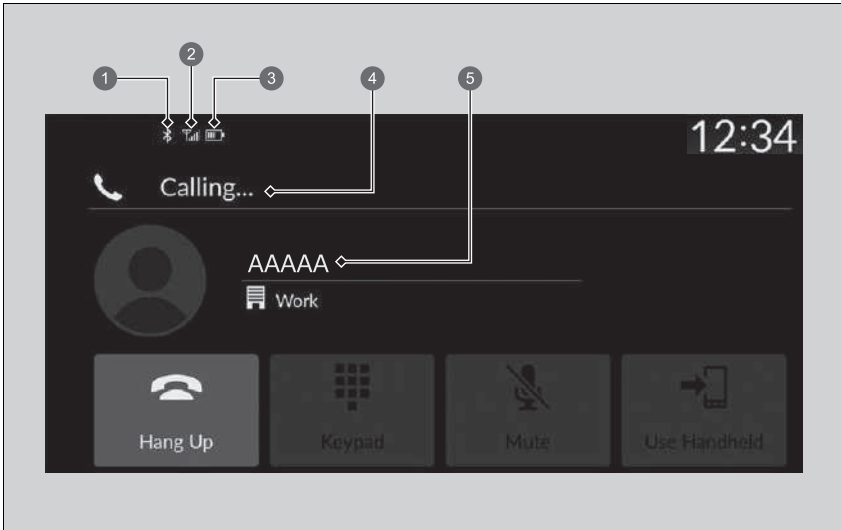

- ① *Bluetooth*® Indicator
Appears when your phone is connected to HFT.
- ② Signal Strength
- ③ Battery Level Status
- ④ HFT Mode
- ⑤ Caller's Name (If registered)/Caller's Number (If not registered)

▣ HFT Status Display

The information that appears on the audio/information screen varies between phone models.

■ Limitations for Manual Operation

Certain manual functions are disabled or inoperable while the vehicle is in motion. You cannot select a grayed-out option until the vehicle is stopped.

Only previously stored phonebook names or numbers can be called using voice commands while the vehicle is in motion.

➤ **Favourite Contacts** P. 351

HFT Menu

The power mode must be in ACCESSORY or ON to use the system. Select **Phone** to display the phone screen.

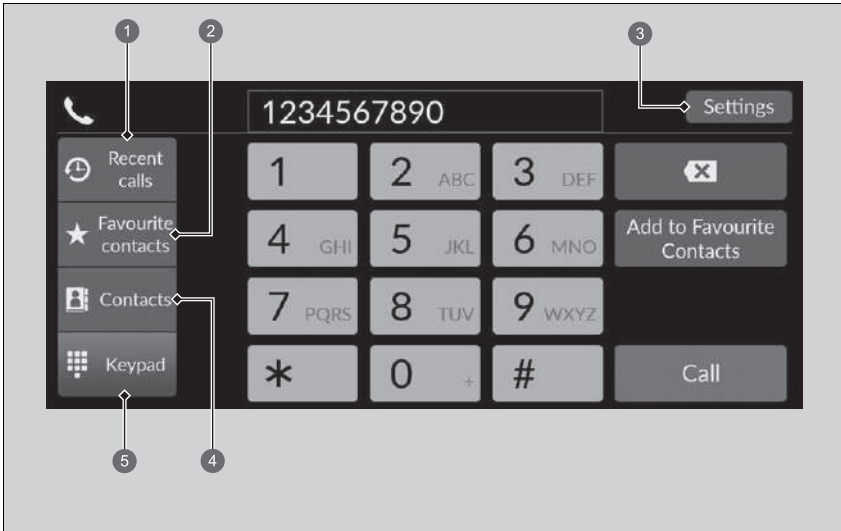

- 1 Recent calls
- 2 Favourite contacts
- 3 Settings
- 4 Contacts
- 5 Keypad

HFT Menu

Some functions are limited while driving.

Recent calls: Displays the last outgoing, incoming, and missed calls.

➤ **To make a call using the recent calls** P. 353

Favourite contacts: Dials the selected number in the Favourite contacts entry.

➤ **To make a call using a Favourite contacts entry** P. 353

Settings: Changes the phone settings.

➤ **Phone Settings Screen** P. 345

Contacts: Displays the phonebook of the paired phone.

➤ **To make a call using the imported phonebook** P. 354

Keypad: Enters a phone number to dial.

➤ **To make a call using a phone number** P. 354

Phone Settings Screen

To display the phone settings screen, select **Settings** on the phone screen.

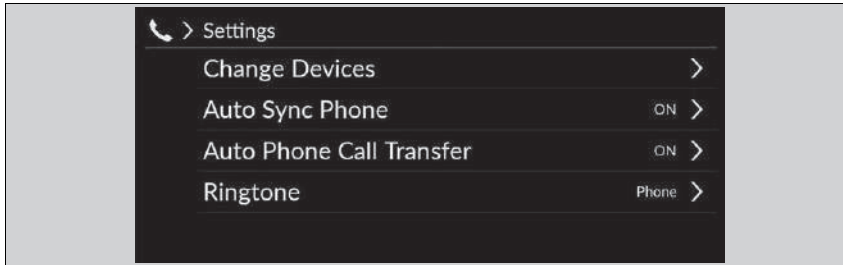

Change Devices: Pairs a new phone to the system and connect, disconnect, or delete a paired device.

➤ **Phone Setup** P. 346

Auto Sync Phone: Sets phonebook and recent calls data to be automatically imported when a phone is paired to HFT.

➤ **Automatic Import of Mobile Phonebook and Recent calls** P. 349

Auto Phone Call Transfer: Sets calls to automatically transfer from your phone to HFT when you enter the vehicle.

➤ **Automatic Transferring** P. 350

Ringtone: Selects the ringtone.

➤ **Ringtone** P. 350

■ Phone Setup

■ **Bluetooth® setup**

You can turn *Bluetooth®* function on and off.

1. Select **General Settings**.
2. Select **Connections**.
3. Select **Bluetooth**.
4. Select **Options**.
5. Select **Bluetooth**, then select **ON**.

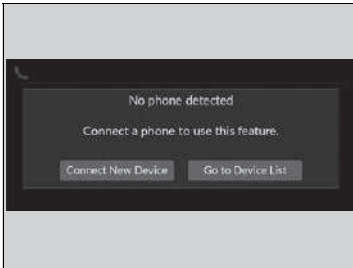

■ **To pair a mobile phone (when there is no phone paired to the system)**

1. Select **Phone**.
2. Select **Connect New Device**.
3. Make sure your phone is in search or discoverable mode.
4. Select **Honda HFT** from your phone.
 - ▶ If you want to pair a phone from this audio system, select **Search for Devices**, and then select your phone when it appears on the list.
5. The system gives you a pairing code on the audio/information screen.
 - ▶ Confirm if the pairing code on the screen and your phone match. This may vary by a phone.
6. Select desired functions and then select **Connect**.
7. A notification appears on the screen if pairing is successful.
8. Select **OK**.



☒ Phone Setup

Your *Bluetooth*-compatible phone must be paired to the system before you can make and receive hands-free calls.

Phone Pairing Tips:

- You cannot pair your phone while the vehicle is moving.
- Up to six phones can be paired.
- Your phone's battery may drain faster when it is paired to the system.







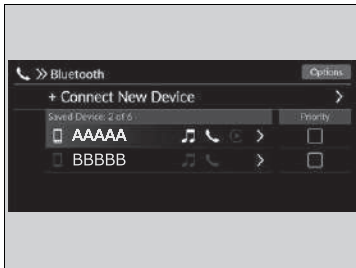

Once you have paired a phone, you can see it displayed on the screen with the following icons.

- : The phone is compatible with *Bluetooth*® Audio.
- : The phone can be used with HFT.
- : The phone is compatible with Apple CarPlay.

If there is an active connection to Apple CarPlay pairing of additional *Bluetooth*® compatible devices is unavailable.



■ To change the currently paired phone

1. Select **Phone**.
2. Select **Settings**.
3. Select **Change Devices**.
4. Select a phone to connect.
 - ▶ HFT disconnects the connected phone and starts searching for another paired phone.
 - ▶ You can set the connected phone priority. Select the box checked on the phone you want to prioritize.
5. Select  (audio), , or  (Apple CarPlay).
 - ▶  and  can be selected simultaneously, however, when  is selected,  and  cannot be selected.
6. Select **Apply**.

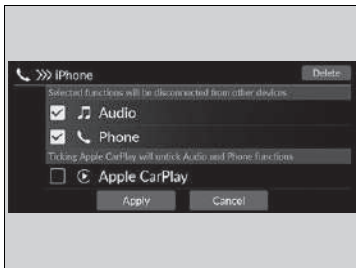

■ To delete a paired phone

1. Select **Phone**.
2. Select **Settings**.
3. Select **Change Devices**.
4. Select a phone you want to delete.
5. Select **Delete**.
6. A confirmation message appears on the screen. Select **Delete**.

▶▶ To change the currently paired phone

If no other phones are found or paired when trying to switch to another phone, HFT will inform you that the original phone is connected again.

To pair other phones, select **+ Connect New Device** from the **Bluetooth** screen.

■ Automatic Import of Mobile Phonebook and Recent calls

When your phone is paired, the contents of its phonebook and recent calls are automatically imported to the system.

1. Select **Phone**.
2. Select **Settings**.
3. Select **Auto Sync Phone**.
4. Select **ON** or **OFF**.
 - ▶ The default setting is **ON**.

⌘ Automatic Import of Mobile Phonebook and Recent calls

On some phones, it is necessary to set up it enabled to be imported the mobile phonebook.

When you select a name from the list in the mobile phonebook, you can see a category icon. The icons indicate what types of numbers are stored for that name.

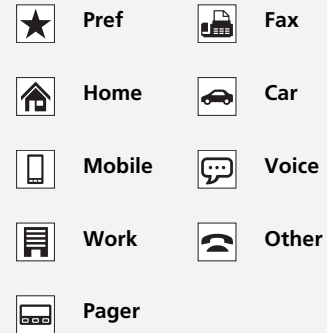

On some phones, it may not be possible to import the category icons to the system.

The phonebook is updated after every connection. Recent calls are updated after every connection or call.

■ Automatic Transferring

If you get into the vehicle while you are on the phone, the call can be automatically transferred to HFT.

1. Select **Phone**.
2. Select **Settings**.
3. Select **Auto Phone Call Transfer**.
4. Select **ON** or **OFF**.
 - The default setting is **ON**.

■ Ringtone

You can change the ringtone setting.

1. Select **Phone**.
2. Select **Settings**.
3. Select **Ringtone**.
4. Select **Vehicle** or **Phone**.
 - The default setting is **Phone**.

☒ Ringtone

Vehicle: The fixed ringtone sounds from the speakers.

Phone: Depending on the make and model of the mobile phone, the ringtone stored in the phone will sound if the phone is connected.

Favourite Contacts

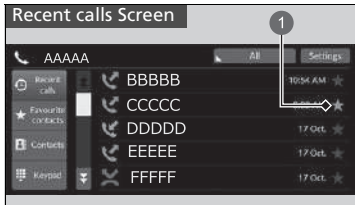

1 Star Icon

■ To add a Favourite contacts

1. Select **Phone**.
2. Select **Recent calls, Contacts, or Keypad**.

On the Recent calls or Contacts screen

3. Select the star icon.

On the Keypad screen

3. Select **Add to Favourite Contacts**.

- ▶ A notification appears on the screen if the Favourite contacts is successfully stored.
- ▶ To remove the Favourite contacts, select the star icon again.

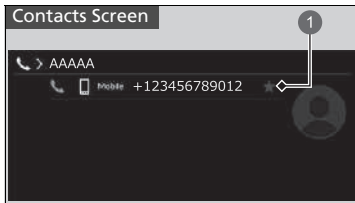

1 Star Icon

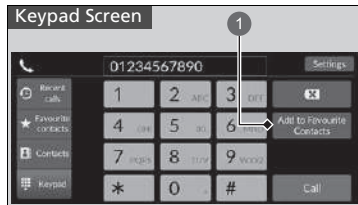

1 Add to Favourite Contacts

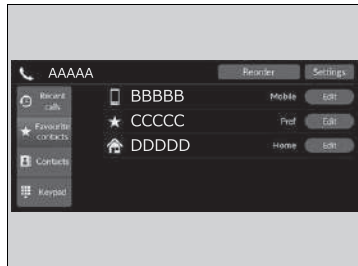

■ To edit a Favourite contacts

1. Select **Phone**.
2. Select **Favourite contacts**.
3. Select **Edit** on the Favourite contacts entry you want to edit.
4. Select a setting you want.
5. Select **Done**.

■ To delete a Favourite contacts

1. Select **Phone**.
2. Select **Favourite contacts**.
3. Select **Edit** on the Favourite contacts entry you want to delete.
4. Select **Remove**.
5. A confirmation message appears on the screen. Select **Yes**.

Making a Call



You can make calls by inputting any phone number, or by using the imported **Recent calls**, **Favourite contacts**, and **Contacts** entries.

■ To make a call using the recent calls

Recent calls are stored by **All**, **Dialled**, **Missed**, and **Received**.

1. Select **Phone**.
2. Select **Recent calls**.
 - ▶ You can sort by **All**, **Dialled**, **Missed**, or **Received**. Select the icon on the upper right of the screen.
3. Select a number.
 - ▶ Dialing starts automatically.

■ To make a call using a Favourite contacts entry

1. Select **Phone**.
2. Select **Favourite contacts**.
 - ▶ You can change the order of Favourite contacts entries by selecting **Reorder**.
3. Select a number.
 - ▶ Dialing starts automatically.

☒ Making a Call

Once a call is connected, you can hear the voice of the person you are calling through the audio speakers.

While there is an active connection with Apple CarPlay, phone calls cannot be made with Hands-Free Telephone (HFT) system and are only made from Apple CarPlay.

☒ To make a call using the recent calls

The recent calls appear only when a phone is connected to the system.

- All:** Displays the last outgoing, incoming, and missed calls.
- Dialled:** Displays the last outgoing calls.
- Missed:** Displays the last missed calls.
- Received:** Displays the last incoming calls.

■ To make a call using the imported phonebook

1. Select **Phone**.
2. Select **Contacts**.
3. Select a name.
 - ▶ You can sort by **First Name** or **Surname**. Select the icon on the upper right of the screen.
4. Select a number.
 - ▶ Dialing starts automatically.

■ To make a call using a phone number

1. Select **Phone**.
2. Select **Keypad**.
3. Select a number.
 - ▶ Use the keyboard on the touch screen for entering numbers.
4. Select **Call**.
 - ▶ Dialing starts automatically.

Receiving a Call

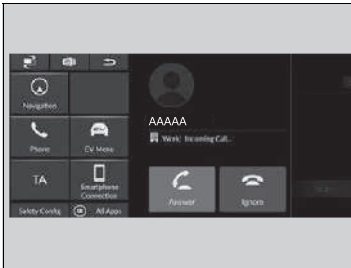

When there is an incoming call, an audible notification sounds (if activated) and the **Incoming Call...** screen appears.

You can answer the call using the left selector wheel.

To pick the call, roll up or down to select  (answer) on the driver information interface and then press the left selector wheel.

- ▶ If you want to decline or end the call, select  (ignore) on the driver information interface using the left selector wheel.

Receiving a Call



Call Waiting

Select  (answer) to put the current call on hold to answer the incoming call.

Select  using the left selector wheel to return to the current call.

Select  (ignore) to ignore the incoming call if you do not want to answer it.

Select  if you want to hang up the current call.

You can select the icons on the audio/information screen instead of  and  on the driver information interface.

Options During a Call

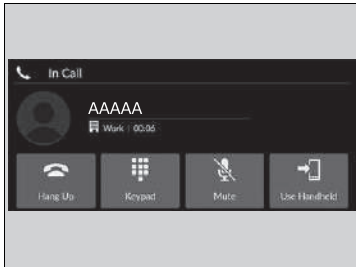

The following options are available during a call.

Keypad: Send numbers during a call. This is useful when you call a menu-driven phone system.

Mute: Mute your voice.

Use Handheld: Transfer a call from the system to your phone.

The available options are shown on the lower half of the centre screen.

Select the option.

- ▶ The mute icon appears when **Mute** is selected when the other source screen other than the phone screen is displayed. Select **Mute** again to turn it off.

Options During a Call

You can select the icons on the audio/information screen.

iPod/USB Flash Drive

If an error occurs while playing an iPod or USB flash drive, you may see the following error messages. If you cannot clear the error message, contact a dealer.

Error Message	Solution
No response from device	Appears when the system does not acknowledge the iPod. Reconnect the iPod.
Connect Retry	
Unplayable File	Appears when the files in the USB flash drive are copyright protected or an unsupported format. This error message appears for about five seconds, then plays the next song.
Unsupported Device	Appears when the system does not communicate with a connected device. If it appears when a device is connected, contact your place of device purchase.
A charging error has occurred with the connected USB device. When safe please check the compatibility of the device and USB cable and try again.	Appears when an incompatible device is connected. Disconnect the device. Then turn the audio system off, and turn it on again. Do not reconnect the device that caused the error.

Compatible iPod, iPhone, and USB Flash Drives

■ iPod and iPhone Model Compatibility

Model
iPod touch (5th to 6th generation) released between 2012 and 2015
iPhone 5/iPhone 5s/iPhone 5c/iPhone 6/iPhone 6 Plus/iPhone 6S/iPhone 6S Plus/ iPhone SE/iPhone 7/iPhone 7 Plus/iPhone 8/iPhone 8 Plus/iPhone X/iPhone XS/ iPhone XS Max/iPhone XR

■ USB Flash Drives

- A USB flash drive of 256 MB or higher is recommended.
- Some digital audio players may not be compatible.
- Some USB flash drives (e.g., a device with security lockout) may not work.
- Some software files may not allow for audio play or text data display.
- Some versions of MP3, WMA, AAC, FLAC, WAV, PCM/WAVE, MP4, AVI, MKV, or ASF/WMV formats may be unsupported.

⌘ iPod and iPhone Model Compatibility

This system may not work with all software versions of these devices.

⌘ USB Flash Drives

Files on the USB flash drive are played in their stored order. This order may be different from the order displayed on your PC or device.

■ Recommended Devices

■ MP4 File

Media	USB Flash Drive	
Profile (MP4 version)	BaselineProfile/Level 3, MainProfile/Level 3.1 (MPEG4-AVC)	SimpleProfile/Level 5 (MPEG4)
File extension (MP4 version)	.mp4/.m4v	
Compatible audio codec	AAC, MP3	
Compatible video codec	MPEG4-AVC (H.264)	MPEG4 (ISO/IEC 14496 Part.2)
Bit rate	10 Mbps, 14 Mbps (MPEG4-AVC)	8 Mbps (MPEG4)
Maximum image	1,280 × 720 pixels (MPEG4-AVC)	720 × 576 pixels (MPEG4)

■ AVI File

Media	USB Flash Drive		
Profile (AVI version)	BaselineProfile/Level 3, MainProfile/Level 3.1 (MPEG4-AVC)	SimpleProfile/Level 5 (MPEG4)	AdvancedProfile/Level 2, MainProfile/Level Medium, SimpleProfile/Level Medium (VC-1)
File extension (AVI version)	.avi		
Compatible audio codec	AAC, MP3, WMA		
Compatible video codec	MPEG4-AVC (H.264)	MPEG4 (ISO/IEC 14496 Part.2)	VC-1
Bit rate	10 Mbps, 14 Mbps (MPEG4-AVC)	8 Mbps (MPEG4)	20 Mbps, 10 Mbps, 384 kbps (VC-1)
Maximum image	1,280 × 720 pixels (MPEG4-AVC)	720 × 576 pixels (MPEG4)	1,280 × 720 pixels, 720 × 480 pixels, 352 × 288 pixels (VC-1)

■ MKV File

Media		USB Flash Drive	
Profile (MKV version)	BaselineProfile/Level 3, MainProfile/Level 3.1 (MPEG4-AVC)	SimpleProfile/Level 5 (MPEG4)	AdvancedProfile/Level 2, MainProfile/Level Medium, SimpleProfile/Level Medium (VC-1)
File extension (MKV version)	.mkv		
Compatible audio codec	AAC, MP3		
Compatible video codec	MPEG4-AVC (H.264)	MPEG4 (ISO/IEC 14496 Part.2)	VC-1
Bit rate	10 Mbps, 14 Mbps (MPEG4-AVC)	8 Mbps (MPEG4)	20 Mbps, 10 Mbps, 384 kbps (VC-1)
Maximum image	1,280 × 720 pixels (MPEG4-AVC)	720 × 576 pixels (MPEG4)	1,280 × 720 pixels, 720 × 480 pixels, 352 × 288 pixels (VC-1)

■ ASF/WMV File

Media		USB Flash Drive	
Profile (ASF/WMV version)	BaselineProfile/Level 3, MainProfile/Level 3.1 (MPEG4-AVC)	AdvancedProfile/Level 2, MainProfile/Level Medium, SimpleProfile/Level Medium (VC-1)	
File extension (ASF/WMV version)	.asf/.wmv		
Compatible audio codec	WMA		
Compatible video codec	MPEG4-AVC (H.264)	VC-1	
Bit rate	10 Mbps, 14 Mbps (MPEG4-AVC)	20 Mbps, 10 Mbps, 384 kbps (VC-1)	
Maximum image	1,280 × 720 pixels (MPEG4-AVC)	1,280 × 720 pixels, 720 × 480 pixels, 352 × 288 pixels (VC-1)	

About Open Source Licences

To see the open source licence information, follow these steps.

1. Select **General Settings**.
2. Select **System**.
3. Select **Detail Information**.

■ Software for the Display Audio

Copyright 2014 jQuery Foundation and other contributors

<http://jquery.com/>

Permission is hereby granted, free of charge, to any person obtaining a copy of this software and associated documentation files (the "Software"), to deal in the Software without restriction, including without limitation the rights to use, copy, modify, merge, publish, distribute, sublicense, and/or sell copies of the Software, and to permit persons to whom the Software is furnished to do so, subject to the following conditions:

The above copyright notice and this permission notice shall be included in all copies or substantial portions of the Software.

THE SOFTWARE IS PROVIDED "AS IS", WITHOUT WARRANTY OF ANY KIND, EXPRESS OR IMPLIED, INCLUDING BUT NOT LIMITED TO THE WARRANTIES OF MERCHANTABILITY, FITNESS FOR A PARTICULAR PURPOSE AND NONINFRINGEMENT. IN NO EVENT SHALL THE AUTHORS OR COPYRIGHT HOLDERS BE LIABLE FOR ANY CLAIM, DAMAGES OR OTHER LIABILITY, WHETHER IN AN ACTION OF CONTRACT, TORT OR OTHERWISE, ARISING FROM, OUT OF OR IN CONNECTION WITH THE SOFTWARE OR THE USE OR OTHER DEALINGS IN THE SOFTWARE.

Licence Information

■ Bluetooth

The *Bluetooth*® word mark and logos are registered trademarks owned by Bluetooth SIG, Inc. and any use of such marks by Panasonic Automotive Systems Co., Ltd. is under license. Other trademarks and trade names are those of their respective owners.

<https://www.bluetooth.com/develop-with-bluetooth/marketing-branding/>



■ Windows Media

This product is protected by certain intellectual property rights of Microsoft. Use or distribution of such technology outside of this product is prohibited without a license from Microsoft.

■ Apple

“Made for iPod,” and “Made for iPhone,” mean that an electronic accessory has been designed to connect specifically to iPod, or iPhone, respectively, and has been certified by the developer to meet Apple performance standards. Apple is not responsible for the operation of this device or its compliance with safety and regulatory standards. Please note that the use of this accessory with iPod, or iPhone, may affect wireless performance.

Apple, the Apple Logo, iPhone, iPod touch are trademarks of Apple Inc., registered in the U.S. and other countries. Apple CarPlay, iPod, iPhone, iTunes, Siri and Lightning are trademarks of Apple Inc. App Store is a service mark of Apple Inc.



■ MPEG

Mpeg4 Visual

THIS PRODUCT IS LICENSED UNDER THE MPEG-4 VISUAL PATENT PORTFOLIO LICENSE FOR THE PERSONAL AND NON-COMMERCIAL USE OF A CONSUMER FOR (i) ENCODING VIDEO IN COMPLIANCE WITH THE MPEG-4 VISUAL STANDARD (“MPEG-4 VIDEO”) AND/OR (ii) DECODING MPEG-4 VIDEO THAT WAS ENCODED BY A CONSUMER ENGAGED IN A PERSONAL AND NONCOMMERCIAL ACTIVITY AND/OR WAS OBTAINED FROM A VIDEO PROVIDER LICENSED BY MPEG LA TO PROVIDE MPEG-4 VIDEO. NO LICENSE IS GRANTED OR SHALL BE IMPLIED FOR ANY OTHER USE. ADDITIONAL INFORMATION INCLUDING THAT RELATING TO PROMOTIONAL, INTERNAL AND COMMERCIAL USES AND LICENSING MAY BE OBTAINED FROM MPEG LA, LLC. SEE [HTTP://WWW.MPEGLA.COM](http://www.mpegla.com).

VC-1

THIS PRODUCT IS LICENSED UNDER THE VC-1 PATENT PORTFOLIO LICENSE FOR THE PERSONAL AND NON-COMMERCIAL USE OF A CONSUMER TO (i) ENCODE VIDEO IN COMPLIANCE WITH THE VC-1 STANDARD (“VC-1 VIDEO”) AND/OR (ii) DECODE VC-1 VIDEO THAT WAS ENCODED BY A CONSUMER ENGAGED IN A PERSONAL AND NON-COMMERCIAL ACTIVITY AND/OR WAS OBTAINED FROM A VIDEO PROVIDER LICENSED TO PROVIDE VC-1 VIDEO. NO LICENSE IS GRANTED OR SHALL BE IMPLIED FOR ANY OTHER USE. ADDITIONAL INFORMATION MAY BE OBTAINED FROM MPEG LA, L.L.C. SEE [HTTP://WWW.MPEGLA.COM](http://www.mpegla.com).

AVC/H.264

THIS PRODUCT IS LICENSED UNDER THE AVC PATENT PORTFOLIO LICENSE FOR THE PERSONAL AND NONCOMMERCIAL USE OF A CONSUMER TO (i) ENCODE VIDEO IN COMPLIANCE WITH THE AVC STANDARD ("AVC VIDEO") AND/OR (ii) DECODE AVC VIDEO THAT WAS ENCODED BY A CONSUMER ENGAGED IN A PERSONAL AND NON-COMMERCIAL ACTIVITY AND/OR WAS OBTAINED FROM A VIDEO PROVIDER LICENSED TO PROVIDE AVC VIDEO. NO LICENSE IS GRANTED OR SHALL BE IMPLIED FOR ANY OTHER USE.

ADDITIONAL INFORMATION MAY BE OBTAINED FROM MPEG LA, L.L.C. SEE [HTTP://WWW.MPEGLA.COM](http://www.mpegla.com).

Legal Information on Apple CarPlay/Android Auto

■ OWNER'S MANUAL LICENSE/LIABILITY STATEMENTS

USE OF APPLE CARPLAY IS SUBJECT TO YOUR AGREEMENT TO THE CARPLAY TERMS OF USE, WHICH ARE INCLUDED AS PART OF THE APPLE iOS TERMS OF USE. IN SUMMARY, THE CARPLAY TERMS OF USE DISCLAIM APPLE AND ITS SERVICE PROVIDERS' LIABILITY IF THE SERVICES FAIL TO PERFORM CORRECTLY OR ARE DISCONTINUED, STRICTLY LIMIT APPLE AND ITS SERVICE PROVIDERS' OTHER LIABILITIES, DESCRIBE THE KINDS OF USER INFORMATION (INCLUDING, FOR EXAMPLE, VEHICLE LOCATION, VEHICLE SPEED, AND VEHICLE STATUS) BEING GATHERED AND STORED BY APPLE AND ITS SERVICE PROVIDERS, AND DISCLOSE CERTAIN POSSIBLE RISKS ASSOCIATED WITH THE USE OF CARPLAY, INCLUDING THE POTENTIAL FOR DRIVER DISTRACTION. SEE APPLE'S PRIVACY POLICY FOR DETAILS REGARDING APPLE'S USE AND HANDLING OF DATA UPLOADED BY CARPLAY.

USE OF ANDROID AUTO IS SUBJECT TO YOUR AGREEMENT TO THE ANDROID AUTO TERMS OF USE WHICH MUST BE AGREED TO WHEN THE ANDROID AUTO APPLICATION IS DOWNLOADED TO YOUR ANDROID PHONE. IN SUMMARY, THE ANDROID AUTO TERMS OF USE DISCLAIM GOOGLE AND ITS SERVICE PROVIDERS' LIABILITY IF THE SERVICES FAIL TO PERFORM CORRECTLY OR ARE DISCONTINUED, STRICTLY LIMIT GOOGLE AND ITS SERVICE PROVIDERS' OTHER LIABILITIES, DESCRIBE THE KINDS OF USER INFORMATION (INCLUDING, FOR EXAMPLE, VEHICLE LOCATION, VEHICLE SPEED, AND VEHICLE STATUS) BEING GATHERED AND STORED BY GOOGLE AND ITS SERVICE PROVIDERS, AND DISCLOSE CERTAIN POSSIBLE RISKS ASSOCIATED WITH THE USE OF ANDROID AUTO, INCLUDING THE POTENTIAL FOR DRIVER DISTRACTION. SEE GOOGLE'S PRIVACY POLICY FOR DETAILS REGARDING GOOGLE'S USE AND HANDLING OF DATA UPLOADED BY ANDROID AUTO.

DISCLAIMER OF WARRANTIES; LIMITATION ON LIABILITY

YOU EXPRESSLY ACKNOWLEDGE AND AGREE THAT USE OF APPLE CARPLAY OR ANDROID AUTO (“THE APPLICATIONS”) IS AT YOUR SOLE RISK AND THAT THE ENTIRE RISK AS TO SATISFACTORY QUALITY, PERFORMANCE, ACCURACY AND EFFORT IS WITH YOU TO THE MAXIMUM EXTENT PERMITTED BY APPLICABLE LAW, AND THAT THE APPLICATIONS AND INFORMATION ON THE APPLICATIONS IS PROVIDED “AS IS” AND “AS AVAILABLE,” WITH ALL FAULTS AND WITHOUT WARRANTY OF ANY KIND, AND HONDA HEREBY DISCLAIMS ALL WARRANTIES AND CONDITIONS WITH RESPECT TO THE APPLICATIONS AND INFORMATION ON THE APPLICATIONS, EITHER EXPRESS, IMPLIED OR STATUTORY, INCLUDING, BUT NOT LIMITED TO, THE IMPLIED WARRANTIES AND/OR CONDITIONS OF MERCHANTABILITY, SATISFACTORY QUALITY, FITNESS FOR A PARTICULAR PURPOSE, ACCURACY, QUIET ENJOYMENT, AND NON-INFRINGEMENT OF THIRD PARTY RIGHTS. NO ORAL OR WRITTEN INFORMATION OR ADVICE GIVEN BY HONDA OR AN AUTHORISED REPRESENTATIVE SHALL CREATE A WARRANTY. AS EXAMPLES, AND WITHOUT LIMITATION, HONDA DISCLAIMS ANY WARRANTY REGARDING THE ACCURACY OF DATA PROVIDED BY THE APPLICATIONS, SUCH AS THE ACCURACY OF DIRECTIONS, ESTIMATED TRAVEL TIME, SPEED LIMITS, ROAD CONDITIONS, NEWS, WEATHER, TRAFFIC, OR OTHER CONTENT PROVIDED BY APPLE, GOOGLE, THEIR AFFILIATES, OR THIRD PARTY PROVIDERS; HONDA DOES NOT GUARANTEE AGAINST LOSS OF APPLICATION DATA, WHICH MAY BE LOST AT ANY TIME; HONDA DOES NOT GUARANTEE THAT THE APPLICATIONS OR ANY SERVICES PROVIDED THROUGH THEM WILL BE PROVIDED AT ALL TIMES OR THAT ANY OR ALL SERVICES WILL BE AVAILABLE AT ANY PARTICULAR TIME OR LOCATION. FOR EXAMPLE, SERVICES MAY BE SUSPENDED OR INTERRUPTED WITHOUT NOTICE FOR REPAIR, MAINTENANCE, SECURITY FIXES, UPDATES, ETC., SERVICES MAY BE UNAVAILABLE IN YOUR AREA OR LOCATION, ETC. IN ADDITION, YOU UNDERSTAND THAT CHANGES IN THIRD PARTY TECHNOLOGY OR GOVERNMENT REGULATION MAY RENDER THE SERVICES AND/OR APPLICATIONS OBSOLETE AND/OR UNUSABLE.

TO THE EXTENT NOT PROHIBITED BY LAW, IN NO EVENT SHALL HONDA OR ITS AFFILIATES BE LIABLE FOR PERSONAL INJURY, OR ANY INCIDENTAL, SPECIAL, INDIRECT OR CONSEQUENTIAL DAMAGES WHATSOEVER, INCLUDING, WITHOUT LIMITATION, DAMAGES FOR LOSS OF PROFITS, CORRUPTION OR LOSS OF DATA, FAILURE TO TRANSMIT OR RECEIVE ANY DATA, BUSINESS INTERRUPTION OR ANY OTHER COMMERCIAL DAMAGES OR LOSSES, ARISING OUT OF OR RELATED TO THE APPLICATIONS OR YOUR USE OF OR INABILITY TO USE THE APPLICATIONS OR INFORMATION ON THE APPLICATIONS, HOWEVER CAUSED, REGARDLESS OF THE THEORY OF LIABILITY (CONTRACT, TORT OR OTHERWISE) AND EVEN IF HONDA WERE ADVISED OF THE POSSIBILITY OF SUCH DAMAGES. SOME REGIONS AND JURISDICTIONS MAY DISALLOW THE EXCLUSION OR LIMITATION OF LIABILITY FOR DAMAGES, SO THESE LIMITATIONS AND EXCLUSIONS MAY NOT APPLY TO YOU. THE FOREGOING LIMITATIONS WILL APPLY EVEN IF THE ABOVE STATED REMEDY FAILS OF ITS ESSENTIAL PURPOSE.

Automatic emergency call

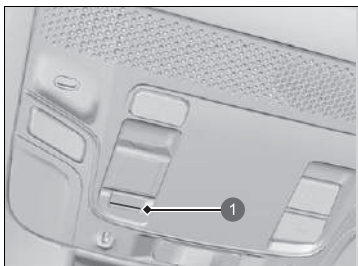

1 eCall Indicator

- Vehicle identification number (VIN)
- Type of vehicle (passenger vehicle or light-weight commercial vehicle)
- Type of energy stored for vehicle propulsion (gasoline/diesel/CNG/LPG/electricity/hydrogen)
- Last three locations of the vehicle
- Direction of travel
- Triggering mode (automatic or manual)
- Timestamp

When an emergency call is initiated, the vehicle speakers are disabled so that you can hear the operator.

When the power mode is set to ON, the eCall indicator lights up in green for 1 second, then in red for 1 second.

If your vehicle is involved in a collision, the SRS unit in the vehicle will attempt to connect to a Public Safety Answering Point (PSAP) operator. Once a connection is established, various information about the vehicle will be sent to a PSAP operator with whom you will be able to speak. This information includes:

Emergency Call (eCall)

Your vehicle is equipped with the 112-based eCall service system.

The 112-based eCall service is a public service of general interest and is accessible free of charge.

The 112-based eCall in-vehicle system is activated when the power mode is set to ON. In the event of a collision, the system will determine the degree of the impact based on information collected from the on-board sensors and, depending on the severity of the collision, will initiate the emergency call.

The 112-based eCall in-vehicle system can also be triggered manually, if needed.

Manual emergency call P. 370

Any processing of personal data through the 112-based eCall in-vehicle system shall comply with the personal data protection rules provided for in Directives 95/46/EC (replaced by 2016/679/EC) and 2002/58/EC, and in particular, shall be based on the necessity to protect the vital interests of the individuals in accordance with Article 7(d) of Directive 95/46/EC (replaced by 2016/679/EC).

Processing of such data is strictly limited to the purpose of for which the single European emergency number 112 is designated.

If the eCall system is working properly, the indicator will light up in green.

- Green: eCall system is ready.
- Blinking in green: eCall system is connected and making an eCall to a PSAP operator.
- Repeating a pattern of short flashes of the red light: The eCall system has failed to connect to an operator. The eCall indicator will continue this pattern for 5 seconds, then it will light up in green.

If the 112-based eCall system is disabled in the event of a critical system failure, the following warning will be given to the occupants of the vehicle:

- Red or blacked out: A problem with the eCall system has occurred. If the indicator stays red or blacked out even after you have restarted the vehicle, have the system check by a dealer.
- Blinking in red: The level of the backup battery is too low. While the power is in ON, the battery undergoes recharging. Once the battery has been recharged to a certain level, the eCall indicator lights up in green.

☒ Emergency Call (eCall)

Recipients of data processed by the 112-based eCall in-vehicle system are the relevant public safety answering points designated by the respective public authorities of the country in which they are located and are the first to receive and for which the single European emergency number 112 is designated.

Your vehicle may NOT be able to connect to a PSAP operator if:

- both the 12V battery and backup battery are too low.
- your vehicle is in an area without adequate cellular coverage.
- There is a problem with the eCall system itself or its peripheral equipment such as the microphone or speakers.

The backup battery is designed to operate for at least 3 years, after which it may need to be replaced.

The backup battery is not available for direct purchase. For replacement, visit a dealer.

Manual emergency call

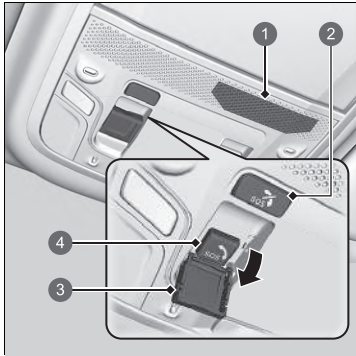

- 1 Microphone
- 2 **SOS** Cancel Button
- 3 Cover
- 4 **SOS** Button

The **SOS** button is protected by a cover. Open the cover to gain access.

When an emergency call is initiated, the vehicle speakers are disabled so that you can hear the operator.

Manual emergency call

Do NOT press the button while you are driving. If you need to contact an operator, park the vehicle in a safe place before you make a call.

If the eCall system at first fails to connect to a PSAP operator, it will try again until a connection is established. However, if 2 minutes have elapsed since the first try was attempted, the system will no longer attempt to establish a connection.

The **SOS** cancel button does not cancel a call once the system is connected to an operator.

☒ Emergency Call (eCall)

Data privacy

The 112-based eCall in-vehicle system is designed to ensure that:

- Data contained in the system memory is not available outside the system before an eCall is triggered.
- It is not traceable or subject to any constant tracking during its normal operation status.
- Data in the internal memory of the system is automatically and continuously removed.

For the system to function normally, the vehicle location data is constantly overwritten in the internal memory of the system so that the last three locations of the vehicle are kept up-to-date.

The log of activity data in the 112-based eCall in-vehicle system is kept for no longer than necessary for attaining the purpose of handling the emergency eCall and in any case not beyond 13 hours from the moment an emergency eCall was initiated.

» Emergency Call (eCall)

Owner's rights

The data subject (the vehicle's owner) has a right of access to data and as appropriate to request the rectification, erasure or blocking of data, concerning him or her, the processing of which does not comply with the provisions of Directive 95/46/EC (replaced by 2016/679/EC).

Any third parties to whom the data have been disclosed have to be notified of such rectification, erasure or blocking carried out in compliance with this Directive, unless it proves impossible or involves a disproportionate effort.

The data subject has a right to complain to the competent data protection authority if he or she considers that his or her rights have been infringed as a result of the processing of his or her personal data.

Honda eCall Service Information:

If you have any questions about eCall, contact the office relevant to the country in which you reside. See the service book or your local Honda website for a list of offices.



Driving

This chapter discusses driving and charging.

Before Driving	374	Intelligent Speed Limiter.....	408	Lead Car Departure Notification System ...	482
Towing a Trailer	378	Vehicle Stability Assist (VSA) System.....	416	Traffic Sign Recognition System	486
When Driving		Deflation Warning System.....	418	Front Sensor Camera	492
Turning on the Power	379	Blind spot information System.....	421	Radar Sensor	494
Precautions While Driving.....	382	Honda Sensing	425	Sonar Sensors.....	495
Transmission	383	Collision Mitigation Braking System		Braking	497
Shifting.....	384	(CMBS)	428	Parking Your Vehicle	507
Drive Mode Switch.....	391	Low Speed Braking Control.....	439	Multi-View Camera	517
Deceleration Paddle Selector	393	Adaptive Cruise Control (ACC) with Low		Honda Parking Pilot	531
Single Pedal Control.....	396	Speed Follow	445	Charging	556
Acoustic Vehicle Alerting System.....	402	Lane Keeping Assist System (LKAS) ..	465	Energy Economy	570
Adjustable Speed Limiter.....	403	Road Departure Mitigation System...	476		

Driving Preparation

Check the following items before you start driving.

Exterior Checks

- Make sure there are no obstructions on the windows, side camera mirror, exterior lights, or other parts of the vehicle.
 - ▶ Remove any frost, snow, or ice.
 - ▶ Remove any snow on the roof, as this can slip down and obstruct your field of vision while driving. If frozen solid, remove ice once it has softened.
 - ▶ When removing ice from around the wheels, be sure not to damage the wheel or wheel components.
- Make sure the bonnet is securely closed.
 - ▶ If the bonnet opens while driving, your front view will be blocked.
- Make sure the tyres are in good condition.
 - ▶ Check air pressures, and check for damage and excessive wear.
 - ✎ **Checking and Maintaining Tyres** P. 603
- Make sure there are no people or objects behind or around the vehicle.
 - ▶ There are blind spots from the inside.
- Disconnect the charger cable.

Exterior Checks

NOTICE

When doors are frozen shut, use warm water around the door edges to melt any ice. Do not try to force them open, as this can damage the rubber trim around the doors.

Do not force the door open or closed if the window has frozen.

This vehicle has a mechanism that automatically lowers the window when the door is opened.

If the window cannot be lowered, it may scrape against the vehicle body when the door is opened or closed.

If the window has frozen, pour warm water all over it to melt the ice.

When done, wipe dry to avoid further freezing.

Do not pour warm water into the key cylinder. You will be unable to insert the key if the water freezes in the hole.

Interior Checks

- Store or secure all items on board properly.
 - ▶ Carrying too much luggage, or improperly storing it, can affect your vehicle's handling, stability, stopping distance, and tyres, and make it unsafe.
 - 🔧 **Load Limit** P. 377
- Do not pile items higher than the seat height.
 - ▶ They can block your view and may be thrown forward in the event of sudden braking.
- Do not place anything in the front seat footwells. Make sure to secure the floor mat.
 - ▶ An object or unsecured floor mat can interfere with your brake and accelerator pedal operation while driving.
- If you have any animals on board, do not let them move around in the vehicle.
 - ▶ They may interfere with driving and a crash could occur.
- Securely close all doors and the tailgate.
- Adjust your seating position properly.
 - ▶ Adjust the head restraint, too.
 - 🔧 **Seats** P. 226
 - 🔧 **Adjusting the Front Head Restraint Positions** P. 231
- Adjust the side camera mirror system, centre camera mirror system, rearview mirror, and steering wheel properly.
 - ▶ Adjust them while sitting in the proper driving position.
 - 🔧 **Adjustment of Each Type of Mirror** P. 215
 - 🔧 **Adjusting the Steering Wheel** P. 214

Interior Checks

Heat from the power system can ignite flammable materials left under the luggage area, causing a fire. If you've parked your vehicle for an extended period, inspect and remove any debris that may have collected, such as dried grass and leaves that have fallen or have been carried in for use as a nest by a small animal. Also check under the luggage area for leftover flammable materials after you or someone else has performed maintenance on your vehicle.

The headlight aim is set by the factory, and does not need to be adjusted. However, if you regularly carry heavy items in the luggage area, have the aiming readjusted at a dealer or by a qualified technician.

Your vehicle is equipped with the automatic headlight adjusting system that automatically adjusts the vertical angle of the low beam headlights.

- Be sure items placed on the floor behind the front seats cannot roll under the seats.
 - ▶ They can interfere with the driver's ability to operate the pedals, or the operation of the seats.
- Everyone in the vehicle must fasten their seat belt.
 - ▶ **Fastening a Seat Belt** P. 51
- Make sure that the indicators in the gauge come on when you start the vehicle, and go off soon after.
 - ▶ Always have a dealer check the vehicle if a problem is indicated.
 - ▶ **Indicators** P. 106

Load Limit

When you load luggage, the total weight of the vehicle, all passengers, and luggage must not exceed the maximum permissible weight.

📄 **Specifications** P. 672

The load for the front and rear axles also must not exceed the maximum permissible axle weight.

📄 **Specifications** P. 672

ⓘ Load Limit

⚠ WARNING

Overloading or improper loading can affect handling and stability and cause a crash in which you can be hurt or killed.

Follow all load limits and other loading guidelines in this manual.

Towing a Trailer

Your vehicle is not designed to tow a trailer. Attempting to do so can void your warranties.

Turning on the Power

When not using the Auto Power ON/OFF



1 Electric Parking Brake Switch

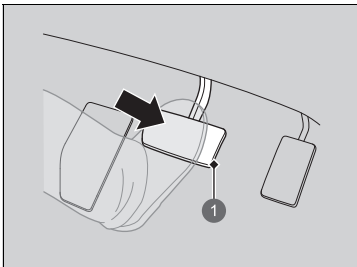

1 Brake Pedal

1. Make sure the parking brake is applied.
 - ▶ The parking brake and brake system indicator comes on for 30 seconds when you pull up the electric parking brake switch.
2. Depress the brake pedal.

Turning on the Power

For directions on the proper handling of the Auto Power ON/OFF, refer to the following page.





➤ **Auto Power ON/OFF** P. 198

Keep your foot firmly on the brake pedal when starting the power system.

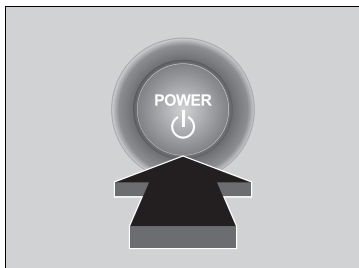
When turning on the power system in cold weather, turn off all electrical accessories such as the lights, climate control system, and rear demister in order to reduce 12-volt battery drain.

If the temperature of the High Voltage battery drops to -30°C or below, the power system will not start. Wait for the High Voltage battery to warm up or move the vehicle to a warmer location. Note using the battery heating system will not help in this case.



3. Without depressing the accelerator pedal, press the **POWER** button while depressing the brake pedal.
4. Check the  (ready) indicator.
 - ▶ Keep depressing the brake pedal until the  (ready) indicator comes on.
 - ▶ The  (ready) indicator comes on when the power system is on and you can start driving.
 - ▶ If the outside temperature is extremely low, you cannot drive until conditions are improved. In this case, the  (ready) indicator does not come on and a warning message appears on the driver information interface.
 - ▶ **Driver Information Interface Warning and Information Messages**
P. 130

▶▶ Turning on the Power

The immobilizer system protects your vehicle from theft.

If an improperly coded key or other device is used, the power system does not activate.

▶ **Immobilizer System** P. 188

When you set the power mode to ON, you may feel the brake pedal slightly down. This is normal.

Bring the keyless remote close to the **POWER** button if the battery in the keyless remote is weak.

▶ **If the Keyless Remote Battery is Weak**
P. 645

The power system may not activate if the keyless remote is subjected to strong radio waves.

▶▶ Stopping the Power System

For directions on the proper handling of the Auto Power ON/OFF, refer to the following page.

▶ **Auto Power ON/OFF** P. 198

■ Stopping the Power System

You can turn the power system off when the vehicle is completely stopped.

1. Depress the brake pedal and change the shift position to **P**.
 - ▶ Do not release the brake pedal until you have confirmed that **P** is shown on the shift position indicator.
2. Press the **POWER** button.

Starting to Drive

1. Keeping your right foot on the brake pedal, check that the  (ready) indicator is on, then put the transmission into **D**. Select **R** when reversing.
2. With the parking brake applied, release the brake pedal and gently depress the accelerator pedal.
 - ▶ Make sure the parking brake and brake system indicator (red) goes off.
 - 🔧 **Parking Brake** P. 497

Hill Start Assist System

Hill start assist keeps the brake engaged briefly to help to prevent the vehicle from rolling on inclines as you move your foot from the brake pedal to the accelerator.

Put the transmission into **D** when facing uphill, or **R** when facing downhill, then release the brake pedal.

Starting to Drive

You can also release the parking brake by pressing the electric parking brake switch while depressing the brake pedal.

When facing downhill, you can start your vehicle more smoothly by manually releasing it with the electric parking brake switch than by releasing it with the accelerator pedal.

Hill Start Assist System

Hill start assist may not prevent the vehicle from rolling downhill on a very steep or slippery slope, and will not operate on small inclines.

Hill start assist is not a replacement for the parking brake.

Precautions While Driving

■ In a Fog

Visibility becomes low when it is foggy. When you drive, turn on the low beam headlights even during the daytime. Slow down, using the road line in the centre, guard rails, and the taillights of the vehicle ahead of you as your driving guide.

■ In a Strong Wind

If a strong side wind drifts your vehicle while driving, hold the steering wheel tight. Slowly decelerate your vehicle and keep your vehicle in the middle of the road. Be careful with wind gusts especially when your vehicle is exiting a tunnel, driving on a bridge or river bank, and driving through an open area like a quarry, and when a large lorry is passing by.

⌘ Precautions While Driving

CAUTION: Do not drive on the road where water is deep. Driving through deep water will cause damage to the power system and electrical equipment and the vehicle will break down.

NOTICE

Do not select a shift button while pressing the accelerator pedal. You could damage the transmission.

NOTICE

If you repeatedly turn the steering wheel at an extremely low speed, or hold the steering wheel in the full left or right position for a while, the electric power steering (EPS) system heats up. The system goes into a protective mode, and limits its performance. The steering wheel becomes harder and harder to operate. Once the system cools down, the EPS system is restored.

Repeated operation under these conditions can eventually damage the system.

If the power mode is set to ACCESSORY while driving, the power system will shut down and all steering and brake power assist functions will stop, making it difficult to control the vehicle.

Do not press the **[N]** button, as you will lose regenerative braking (and acceleration) performance.

■ In Rain

The road is slippery when raining. Avoid hard braking, rapid acceleration, and abrupt steering and be more cautious when driving. It is likely to experience hydroplaning phenomenon if you are driving on a rutted road with puddles. Do not drive in deep water and on flooded roads. This can damage the power system or driveline, or cause electrical component failure.

■ Other Precautions

If there is a strong impact with something under the vehicle, stop in a safe location. Check the underside of the vehicle for damage or any fluid leaks.

Transmission

■ Creeping

When not using the single pedal control

As with a conventional petrol-powered vehicle with an automatic transmission, this vehicle will creep.

Keep the brake pedal firmly depressed when stopped.

⌘ Precautions While Driving

Avoid hard braking for the first 300 km (200 miles). You should also follow this when the brake pads are replaced.

⌘ In Rain

Be careful when hydroplaning phenomenon occurs. When you drive on a road covered with water at excessive speed, a layer of water builds between the tyres and the road surface. If this occurs, the vehicle cannot respond to control inputs such as steering, and braking.

Slowly decelerate when you deceleration stage. If the road is slippery, sudden regenerative braking can cause the tyres to skid.

Shifting

Change the shift position in accordance with your driving needs.

■ Shift button positions

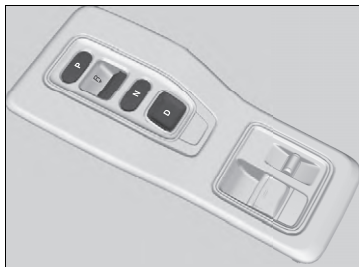

P Parking

Used when parking or before turning the power on or off.

R Reverse

Used when reversing.

N Neutral

Transmission is not locked.

D Drive

Used for:
Normal driving

When not using the single pedal control

- The deceleration paddle selector can be used temporarily.

When using the single pedal control

- The deceleration paddle selector can be used.

Shifting

⚠ WARNING

The vehicle can roll away if left unattended without confirming that Park is engaged.

A vehicle that rolls away could cause a crash resulting in serious injury or death.

Always keep your foot on the brake pedal until you have confirmed that **P** is shown on the shift position indicator.

To prevent malfunction and unintended engagement:

- Do not spill any liquids on or around shift buttons.
- Do not place or drop any objects on or around shift buttons.
- Do not let passengers or children operate the shift buttons.

The message appears on the driver information interface when you depress the accelerator pedal with the shift position in **N**.

Change the shift position to **D** or **R** with the brake pedal depressed.

➤ **Driver Information Interface Warning and Information Messages** P. 130

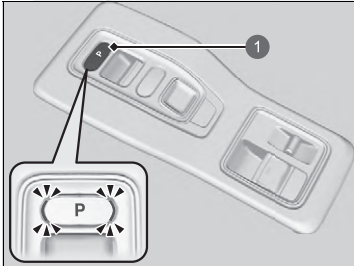
■ P (parking) button**1 P Button**

The shift position changes to **P** when you press the **P** button while the vehicle is parked with the power mode in ON. The indicators on the sides of the **P** button come on.

■ Shift Operation

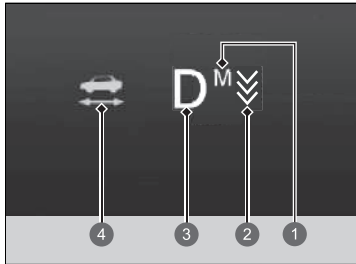

- ① M Indicator
- ② Deceleration Paddle Selector Indicator
- ③ Shift Position Indicator
- ④  (ready) Indicator

▶ Shift Operation

NOTICE

When you change [D] to [R] and vice versa, come to a complete stop and keep the brake pedal depressed. Operating the shift button before the vehicle has come to a complete standstill can damage the transmission.

When changing the shift position to [P], always keep your foot on the brake pedal until you have confirmed that [P] is shown on the shift position indicator.

Use the shift position indicator and the shift button indicator to check the shift position before and after selecting a shift button.

If the indicator of the currently selected shift position, or all the shift position indicators are blinking simultaneously, there is a problem with the transmission.

Avoid sudden acceleration and have the transmission checked by a dealer as soon as possible.

The beeper sounds once when you change to [R].

 **Customized Features** P. 323

When shifting positions in extremely low temperatures (-30°C), there may be a short delay before the shift position is displayed. Always confirm you are in the correct shift position before driving.

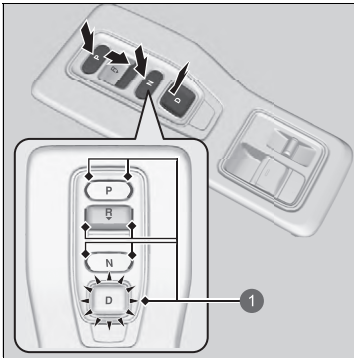

P: Press the **P** button.

R: Press back the **R** button.

N: Press the **N** button.

D: Press the **D** button.

1 Shift Button Indicator

■ When opening the driver's door

If you open the driver's door under the following conditions, the shift position automatically changes to **P**.

- The vehicle is in stationary with the power mode in ON, or moving at 2 km/h (1 mph) or slower.
- The transmission is in other than **P**.
- You have unfastened the driver side seat belt.
 - ▶ If you manually change the shift position from **P** with the brake pedal depressed, the shift position will automatically return to **P** once you release the brake pedal.

■ When turning off the power mode

If you turn the power system off while the vehicle is stationary, and the transmission is in other than **P**, the shift position automatically changes to **P**.

⌘ When opening the driver's door

While the system is designed to automatically change the shift position to **P** under the described conditions, in the interest of safety you should always select **P** before opening the driver's door. Make sure to park the vehicle in a safe place.

➤ **When Stopped** P. 507

If you want to drive the vehicle after the shift position has automatically changed to **P** under the described conditions, close the door, fasten the seat belt, depress the brake pedal, then change the shift position.

If you leave the vehicle, turn off the power system and lock the doors.

■ If you want to keep the transmission in **N** position (car wash mode)

With the power system on:

1. Press and hold the brake pedal.
2. Select **N**.
3. Within five seconds, press the **POWER** button.

The power mode changes to ACCESSORY.

- ▶ This puts the vehicle in car wash mode which must be used when your vehicle is pulled through a conveyor type automatic car wash where you or an attendant do not remain in the vehicle.
- ▶ The shift position remains in **N** with the power mode in ACCESSORY for 15 minutes, then, it automatically changes to **P**.

Manually changing to **P** cancels ACCESSORY mode.



ⓘ If you want to keep the transmission in **N** position (car wash mode)

Note that the transmission may not stay in **N** position while any of the following indicators is on:

- Power system indicator
- Transmission system indicator
- 12-volt battery charging system indicator

■ Restrictions on selecting a shift position

You cannot select a shift position under certain circumstances that may lead to a crash.

When the transmission is in:	1. Under these circumstances:	2. If you try to change to the following:	3. The shift position remains in/changes to:	How to change the shift position
P	The brake pedal is not depressed. The accelerator pedal is depressed.	Other shift position	P	Release the accelerator pedal and depress the brake pedal.
N	The vehicle is moving at low speed without the brake pedal depressed. The vehicle is moving at low speed with the accelerator pedal depressed.		N	
N or D	The vehicle is moving forward.		R	
R or N	The vehicle is moving backward.	D	P	Park your vehicle in a safe place.
R , N , or D	The vehicle is moving.	P		
P or N	The  (ready) indicator is not on.	A shift position other than P or N	P or N	Make sure that the  (ready) indicator comes on.

Drive Mode Switch

Constantly controls your vehicle's motor according to the mode you select. You can select **SPORT** mode or **NORMAL** mode by using the drive mode switch. The current mode is displayed on the driver information interface, and each mode will appear differently.

NORMAL mode is selected every time you set the power mode to ON.

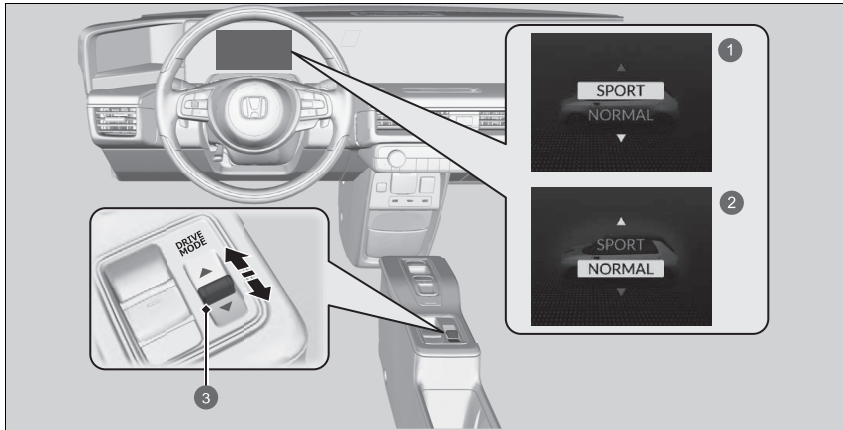

- ① **SPORT** Mode
- ② **NORMAL** Mode
- ③ Drive Mode Switch

Drive Mode Switch

The mode may not be able to be changed when:

- The vehicle is turning.
- The VSA system is activating.
- There is a problem with the brake system, the motor, the battery, and the VSA.

■ SPORT Mode

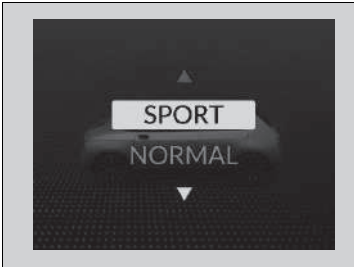

Enhances responsiveness to the driver's input.

■ NORMAL Mode

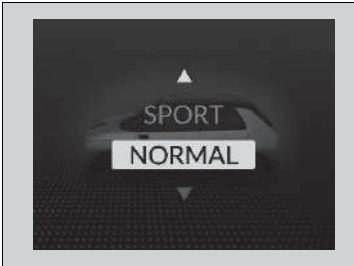

Optimizes the balance between operability and comfort.



Deceleration Paddle Selector

When you release the accelerator pedal, you can control the rate of deceleration without removing your hands from the steering wheel. Using the deceleration paddle selector situated on the steering wheel, you can sequentially shift through four stages of deceleration.

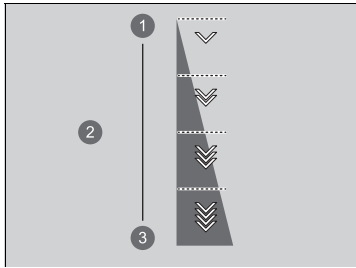
When descending a hill, you can use the deceleration paddle selector to help maintain the rate of deceleration, thereby allowing you to keep a safe distance between your vehicle and the vehicle ahead as well as utilize regenerative braking.





- 1 Decrease
- 2 Deceleration Stage
- 3 Increase

The default deceleration stage is ¹ ². Each paddle selector operation makes a single stage deceleration change.

- ▶ The deceleration stage may not change if you keep the paddle selector pulled back.

To select the different stages of deceleration:

- Pull back the  selector (right side) to decrease the deceleration stage.
- Pull back the  selector (left side) to increase the deceleration stage.

*1: When the **NORMAL** mode is selected.



*2: When the **SPORT** mode is selected.

Deceleration Paddle Selector

CAUTION

Rapidly increasing the deceleration rate by quickly shifting the deceleration paddle can cause the tyres to skid, resulting in a crash that could injure or kill someone.

Always maintain a reasonable rate of deceleration.

If you are descending a hill when you select stage , the vehicle may enter stage .

If you pull back right and left paddle selector at the same time, the deceleration stage may not change.

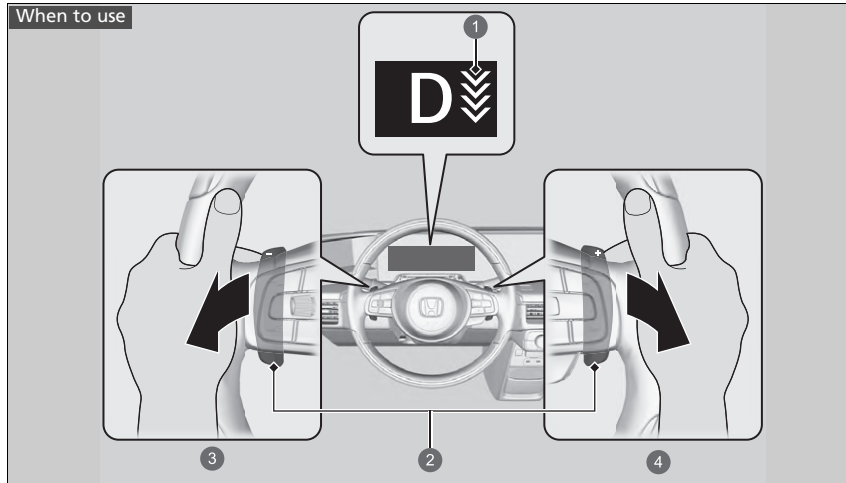

Shift position is in **D**

- ① Deceleration Paddle Selector Indicator
- ② Paddle Selector
- ③ Increase the deceleration stage when pulling the **-** paddle selector (left side)
- ④ Decrease the deceleration stage when pulling the **+** paddle selector (right side)

▶▶ Deceleration Paddle Selector

In the following situations, the stage may not change and the stage icon will blink even if you pull back the selector. The deceleration stage may decrease or cancel automatically:

- The high voltage battery is fully charged or its temperature is too cold or too hot.
- Power system protection is needed.
- The paddle selector is operated while your vehicle is stopped automatically by ACC with Low Speed Follow.

If either paddle selector is operated, ACC with Low Speed Follow will cancel automatically.

■ **When single pedal control is OFF**

If you pull back the paddle selector, the rate of deceleration will change temporarily, and the stage will appear in the driver information interface.

The deceleration paddle selector will cancel automatically and deceleration stage in the driver information interface disappear when you drive with constant speed, situations of acceleration and decelerate just before stopping your vehicle.

Single Pedal Control

Lets you control acceleration and deceleration, as well as keep the vehicle stationary, by use of the accelerator pedal.

When the vehicle is decelerating or is stopped via the system, the brake lights will turn on. In addition, you can switch between three deceleration stages via paddle selectors on the steering wheel.

Single Pedal Control

WARNING

Single Pedal Control is an auxiliary system for deceleration.

If the vehicle begins to move while stopped, the deceleration is not enough, or a warning to depress the brake pedal displays on the gauge, depress the brake pedal immediately.

Overreliance on this function when driving may result in a crash and serious injury or death.

Carefully check your surroundings and operate your vehicle safely.

Do not leave the vehicle while the vehicle is stopped by the system.

If a vehicle moves unexpectedly, it may cause a crash, resulting in serious injury or even death. When parking, change the shift position to  and engage the parking brake.

■ Turning the System On and Off

The system can be turned ON and OFF when the driver's seat belt is fastened, the power mode is set to ON, and the  switch is pressed.

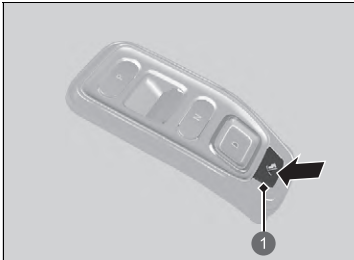

① Single Pedal Switch

- ▶ When the system is ON, the deceleration stage and indicator will display on the gauge.

The system will automatically turn off when you set the power mode to VEHICLE OFF (LOCK).

You can turn the system ON and OFF while driving.

When the vehicle is stopped, you can turn the system ON and OFF by fully depressing the brake pedal.

Situations when the system cannot be turned on:

- The vehicle accelerates/decelerates repeatedly.
- The vehicle is on a long downward slope.
- When driving for a long time with a heavy load.
- Honda Parking Pilot is in use.
- The parking brake and brake system indicator (amber) is on.

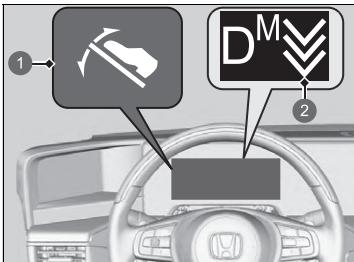

① Single Pedal Control Indicator

② Deceleration Paddle Selector Indicator

⊞ Single Pedal Control

⚠ WARNING

Do not remove your foot from the brake pedal on steep slopes or slippery surfaces.

On steep slopes and slippery surfaces, the car may move if you remove your foot from the brake, even if Single Pedal Control is in use.

If a vehicle moves unexpectedly, it may cause a crash, resulting in serious injury or even death.

Change the shift position to **P** and turn off the system as well as make sure that the parking brake is actually engaged in the following situations:

- When people get in and out of or when removing luggage from the vehicle.
- When stopping for a long time.
- When going through a car wash.
- When using a car turntable.

■ Situations When the System Will Automatically Shut Off

- Adaptive Cruise Control with Low Speed Follow has been activated.
- The driver's seat belt is unfastened while the vehicle is in motion (will turn off when the brake pedal is depressed after parking).
- The vehicle is on a slippery slope or the vehicle has skidded.
- The vehicle accelerates/decelerates repeatedly.
- The vehicle is on a long downward slope.
- When driving for a long time with a heavy load.
- Honda Parking Pilot is in use.
- The brake system indicator is on.
- When using a vehicle turntable.
- The brake system indicator is on while driving.

In the following conditions, the parking brake will automatically activate and the system will shut off:

- Set the power mode to VEHICLE OFF (LOCK) while the vehicle is stopped.
- The brake system indicator is on while the vehicle is stopped.
- The driver's seat belt is unfastened while the vehicle is stopped.
- The vehicle slides down significantly due to a slope while the vehicle is stopped.

System Operation

Using the accelerator pedal, you can adjust the speed of the vehicle while moving forwards or backwards.

In addition, if you let up on the accelerator, you can slow down the vehicle without using the brake pedal, and after stopping, it will keep the vehicle stopped. If you press the accelerator pedal, the function will be cancelled and the vehicle will move.

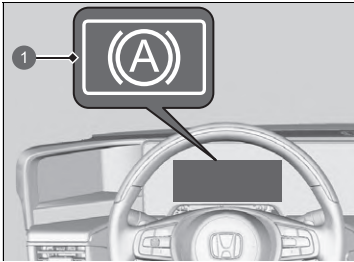

1 Automatic Brake Hold Indicator

The automatic brake hold indicator comes on while the vehicle is stopped. If the vehicle is stopped for 10 minutes or more, the parking brake will be automatically applied.

When the vehicle does not decelerate enough even if you release the accelerator pedal, depress the brake pedal.

System Operation

If a **Single Pedal Control Problem. Depress Brake Pedal When Decelerating And Parked.** warning message displays on the driver information interface, immediately depress the brake pedal.

If the following displays, there may be a problem with the system.

Have your vehicle inspected by a dealer immediately.

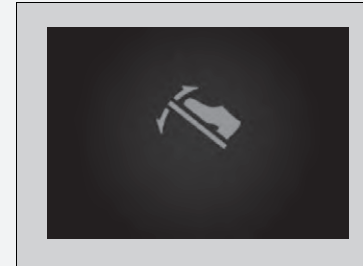

When the system is ON, the vehicle will not creep.

When using the system, just like with foot brakes or other regenerative brakes, there will be wear on the brake pads.

You may hear the system when it is in operation.

■ Adjusting the Deceleration Rate

After turning on the system, you can choose from three decelerations stages. You can change the deceleration rate by pulling on a paddle selector. Each time you pull the paddle selector, the deceleration rate will change by one stage.

- ▶ The stage will not change if you pull and hold the paddle selector.

🔍 Adjusting the Deceleration Rate

WARNING

Be careful when adjusting the deceleration rate.

Depending on the deceleration rate, the tyres may skid on slippery surfaces.

The stage may not change if the right and left paddle selectors are pulled at the same time.

In the following conditions, the stage will not change and the indicator will blink even if you pull the paddle selector.

In addition, the stage may automatically decrease.

- The vehicle accelerates/decelerates repeatedly.
- The vehicle is on a long downward slope.
- The vehicle has been driving for a long time with a heavy load.

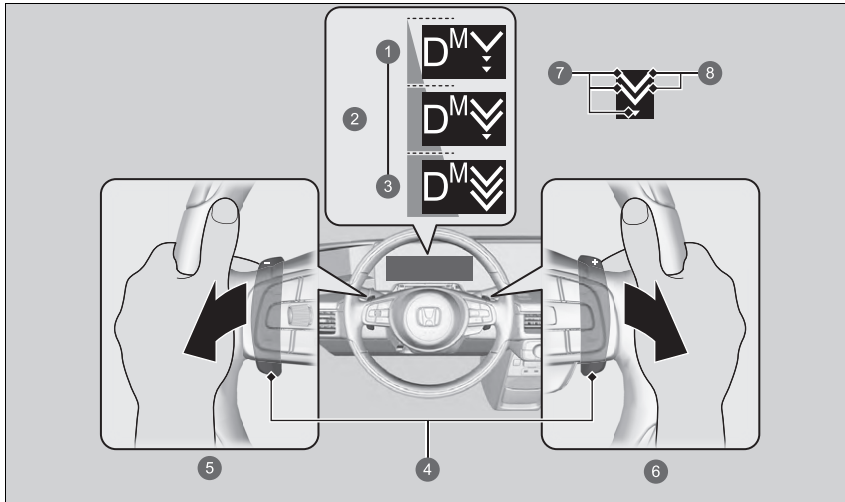

- ❶ Decrease
- ❷ Deceleration Stage
- ❸ Increase
- ❹ Paddle Selector
- ❺ Increase the deceleration stage when pulling the paddle selector (left side)
- ❻ Decrease the deceleration stage when pulling the paddle selector (right side)
- ❼ Shows Possible one to three of Stages
- ❽ Currently Set Stage

Acoustic Vehicle Alerting System

Alerts pedestrians when a vehicle is propelled solely by electricity, approaching at speeds around 25 km/h (16 mph) or less.

Adjustable Speed Limiter

This system enables you to set a maximum speed that cannot be exceeded even if you are depressing the accelerator pedal.

The vehicle speed limit can be set from about 30 km/h (18 mph) to 250 km/h (156 mph).

How to use

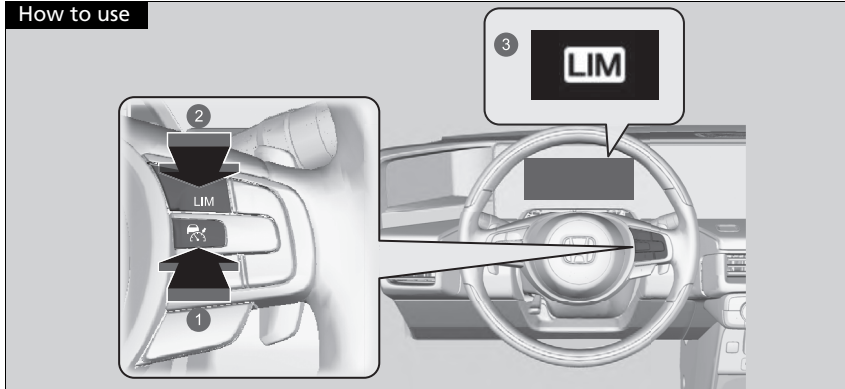

- 1 Press the  button on the steering wheel.
- 2 If a different indicator comes on, press the **LIM** button to switch to the adjustable speed limiter.
- 3 The adjustable speed limiter indicator (white) is on in the gauge. Adjustable speed limiter is ready to use.

Adjustable Speed Limiter

⚠ WARNING

Adjustable Speed Limiter has limitations. It is always your responsibility to adjust the vehicle speed to obey the actual speed limit, and safely operate the vehicle.

⚠ WARNING

Do not depress the accelerator pedal more than necessary. Maintain an appropriate accelerator pedal position depending on the vehicle speed.

The adjustable speed limiter may not hold the set speed limit when driving downhill. If this occurs, slow down by depressing the brake pedal.

When not using the adjustable speed limiter:
Turn off the adjustable speed limiter by pressing the  button.

You cannot use the adjustable speed limiter and the Adaptive Cruise Control (ACC) with Low Speed Follow/Intelligent Speed Limiter at the same time.

■ To Set the Vehicle Speed

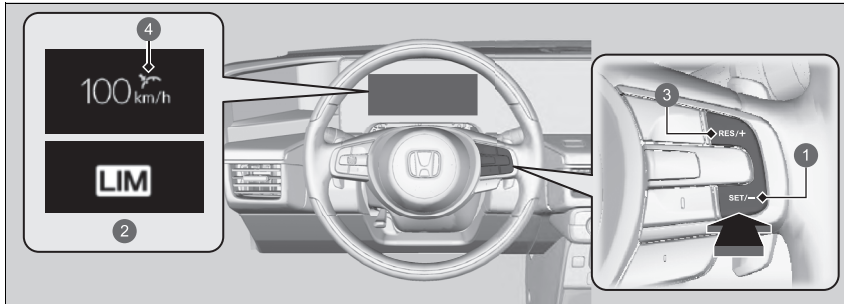

- 1 **SET/-** Button
 - 2 On when the adjustable speed limiter is set (green)
 - 3 **RES/+** Button
 - 4 Setting Status (green)
- Take your foot off the pedal and press the **SET/-** button when you reach the desired speed.
The moment you release the **SET/-** button, the speed limit is fixed, and the adjustable speed limiter is set. The speed limit is displayed.
 - You can set the previously set speed limit by pressing the **RES/+** button.

▶▶ To Set the Vehicle Speed

If you set the speed limit while travelling at less than 30 km/h (18 mph), the speed limit is set to 30 km/h (18 mph).

The beeper sounds and the displayed speed limit blinks if the vehicle speed exceeds the limit by 3 km/h (2 mph) or more on a steep descent.

The adjustable speed limiter is set to the current speed if it is higher than the previously set speed limit when you press the **RES/+** button.

You can switch the displayed set speed measurements between km/h and mph on the driver information interface or the audio/information screen.

▶ **Unit Change** P. 168

▶ **Customized Features** P. 323

■ To Adjust the Speed Limit

Increase or decrease the speed limit by using the **RES/+** or **SET/-** buttons on the steering wheel.

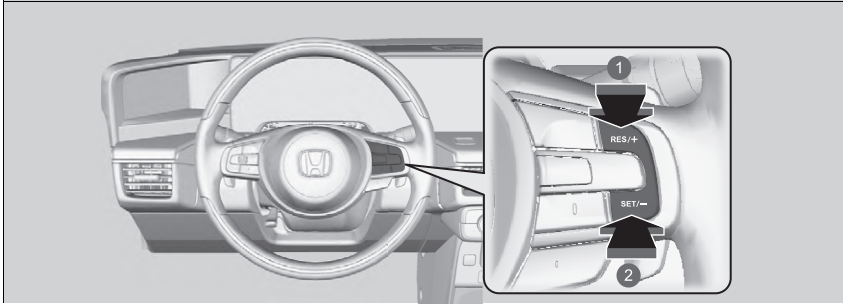

- ① To increase speed
- ② To decrease speed
- Each time you press the button, the speed limit increases or decreases by 1 km/h or 1 mph accordingly.
- If you keep the button pressed, the speed limit increases or decreases in increments of 10 km/h or 10 mph every 0.5 second until system limit is reached.
- The vehicle may accelerate or decelerate until the set speed is reached.

■ Exceeding the Speed Limit Temporarily

The speed limit can be exceeded by depressing the acceleration pedal completely.

- ▶ The displayed limit speed blinks.
- ▶ The beeper sounds once the speed limit has been exceeded.

▣ Exceeding the Speed Limit Temporarily

The beeper sounds when the vehicle speed goes higher than the set speed limit with the acceleration pedal depressed completely.

The adjustable speed limiter resumes working once the vehicle speed goes lower than the set speed limit.

Continued

■ To Cancel

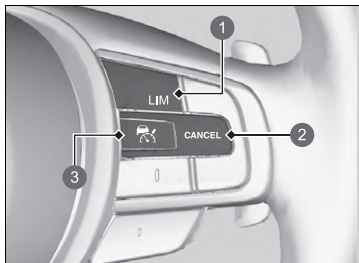

- ① LIM Button
- ② CANCEL Button
- ③  Button

To cancel the adjustable speed limiter, do any of the following:

- Press the **CANCEL** button.
- Press the  button.
- Press the **LIM** button.

▶▶ To Cancel

The adjustable speed limiter changes into Adaptive Cruise Control (ACC) with Low Speed Follow or Intelligent Speed Limiter if the **LIM** button is pressed.

Resuming the prior set speed: **CANCEL** button, the prior set speed is displayed on the gauge in gray.

When pressing the **RES/+** button, the adjustable speed limiter is activated with displayed speed. If the adjustable speed limiter is set to the current speed if it is higher than the previously set speed limit when you press the **RES/+** button.

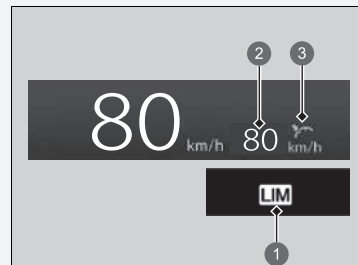

- ① Adjustable Speed Limiter Indicator (white)
- ② Prior Set Speed (gray)
- ③ Setting Status (gray)

▶▶ To Cancel

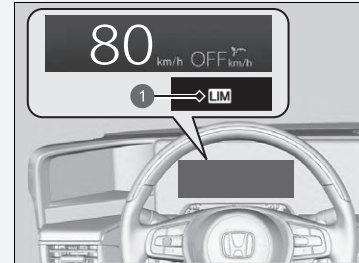

- ① Adjustable Speed Limiter Indicator (white)

If there is a problem with the system when you are using the adjustable speed limiter, the beeper sounds and **OFF** comes on. The adjustable speed limiter will be turned off.

Intelligent Speed Limiter

Automatically sets the speed limit that the traffic sign recognition system detects. And the speed limit cannot be exceeded even if you are depressing the accelerator pedal. If you fully depress the accelerator the speed limit can be exceeded.

➤ **Traffic Sign Recognition System** P. 486

Intelligent Speed Limiter

WARNING

Intelligent Speed Limiter has limitations. The Intelligent Speed Limiter may set itself to a speed above or below the actual speed limit, or may not work, particularly where the traffic sign recognition system does not operate correctly or where a road has no speed limit signs. It is always your responsibility to adjust the speed to obey the actual speed limit and to safely operate the vehicle.

Depending on the amount of depression of the accelerator pedal, the vehicle will accelerate until it reaches the speed identified by the traffic sign recognition system.

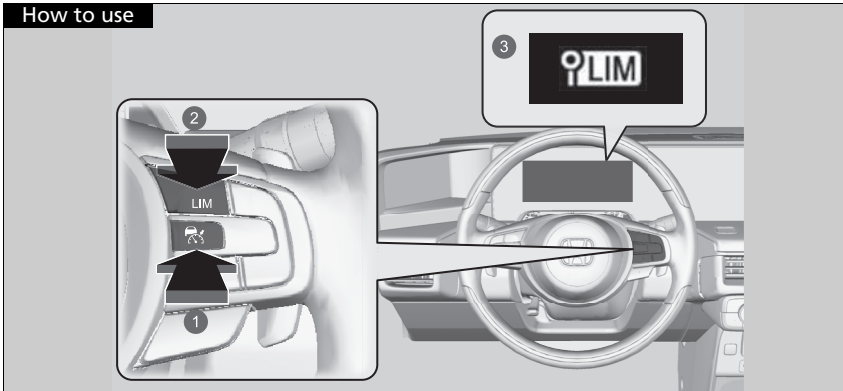

- 1 Press the  button on the steering wheel.
- 2 If a different indicator comes on, press the **LIM** button to change it to the intelligent speed limiter.
- 3 The intelligent speed limiter indicator (white) is on in the gauge. Intelligent speed limiter is ready to use.

Intelligent Speed Limiter

The system is designed to detect signs that follow the Vienna Convention standards. Not all signs may be detected, but any signs posted on roadsides should not be ignored. The system does not work on the designated traffic signs of all the countries you travel, nor in all situations.

Traffic Sign Recognition System P. 486

If the intelligent speed limiter is set to the wrong speed limit, try one of the following:

To cancel

- Press the **CANCEL** button.
- Press the  button.
- Press the **LIM** button.

To exceed the speed limit temporarily

- Depressing the accelerator pedal fully.

The intelligent speed limiter may not hold the set speed limit when driving downhill. If this occurs, slow down by depressing the brake pedal.

When not using the intelligent speed limiter, turn off the intelligent speed limiter by pressing the  button.

You cannot use the intelligent speed limiter and ACC with Low Speed Follow or adjustable speed limiter at the same time.

▶ Intelligent Speed Limiter

Do not use the intelligent speed limiter in areas of different units from the display unit of the intelligent speed limiter.

Change the displayed measurement of the set vehicle speed to the same units as the driving areas.

▶ **Unit Change** P. 168

▶ **Customized Features** P. 323

■ To Set the Speed Limit

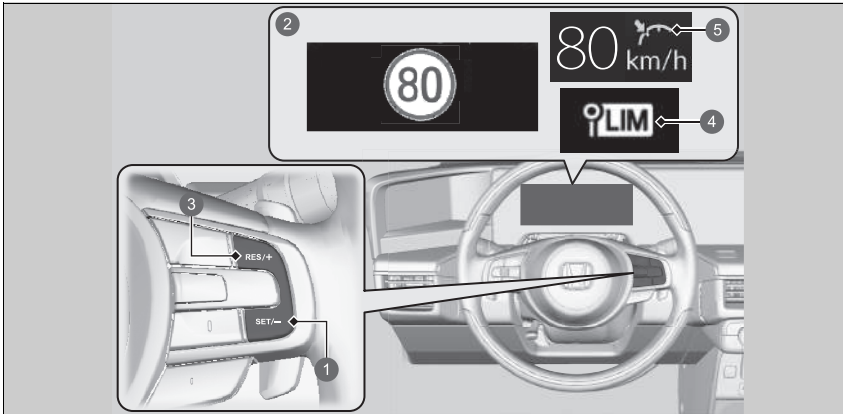

- 1 **SET/-** Button
 - 2 On when the intelligent speed limiter is set to the speed limit that the traffic sign recognition system detects.
 - 3 **RES/+** Button
 - 4 Intelligent Speed Limiter Indicator (green)
 - 5 Setting Status (green)
- The moment you release the **SET/-** button or **RES/+** button, the intelligent speed limiter is set to the speed limit that the traffic sign recognition system detects. The speed limit is displayed.

☒ To Set the Speed Limit

If you set the intelligent speed limiter when the speed limit that the traffic sign recognition system detects is less than 30 km/h (18 mph), the speed limitation function and warning function may switch to pause.

If your vehicle speed is higher than the speed limit that the traffic sign recognition system detects, your vehicle decelerates slowly to the speed limit or less. If necessary, slow down by depressing the brake pedal. And the beeper sounds and the displayed speed limit blinks if the vehicle speed exceeds the limit by 3 km/h (2 mph) or more.

The intelligent speed limiter may also switch to pause when the traffic sign recognition system detects only additional speed limit signs.

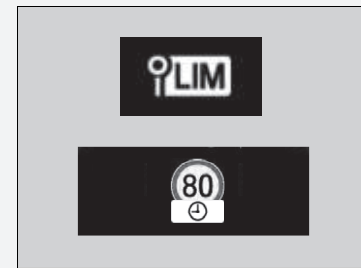

■ **When the traffic sign recognition system detects the new speed limit sign**

The intelligent speed limiter is set to the new speed limit that the traffic sign recognition system detects.



■ **The speed limitation function and warning function may switch to pause if there is no speed limit sign in the screen of the traffic sign recognition system when:**

- The end of speed limit or other designated limit is detected.
- Your vehicle enters/exits motorway or highway.
- You make a turn with a turn signal to change direction at an intersection.



■ When the traffic sign recognition system detects the speed limit sign while the intelligent speed limiter is paused

The speed limitation function and warning function will be resumed automatically.



■ When the traffic sign recognition system does not detect the speed limit sign for a time while the intelligent speed limiter is activated

While driving, in addition to when the traffic sign recognition system detects no speed limit sign, the traffic sign recognition system may display no speed limit. But, intelligent speed limiter functions continue.

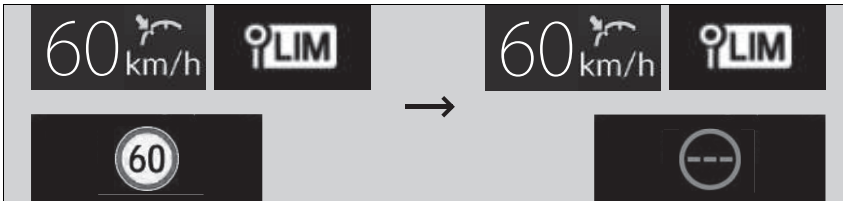

■ To Adjust the Speed Limit

Increase or decrease the speed limit by using the **RES/+** or **SET/-** buttons on the steering wheel.

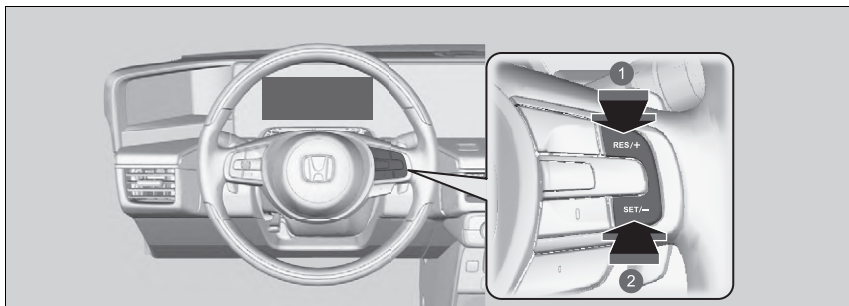

① To increase speed

② To decrease speed

- Each time you press the button, the speed limit is increased or decreased by about 1 km/h or 1 mph accordingly.
- You can increase the speed limit until +10 km/h or +5 mph on the basis of the speed limit that the traffic sign recognition system detects.
- You can decrease the speed limit until -10 km/h or -5 mph on the basis of the speed limit that the traffic sign recognition system detects.
- You can accelerate until the set speed is reached. If your vehicle speed is higher than the speed limit that the traffic sign recognition system detects, your vehicle decelerates slowly to the speed limit.

▶▶ To Adjust the Speed Limit

A negative or positive offset with respect to the speed limit will be reset automatically when the traffic sign recognition system detects the new speed limit sign.

You cannot decrease the speed limit less than 30 km/h (18 mph).

■ Exceeding the Speed Limit Temporarily

The speed limit can be exceeded by depressing the accelerator pedal fully.

- ▶ The displayed speed limit blinks.
- The beeper sounds once the speed limit has been exceeded.

■ To Cancel

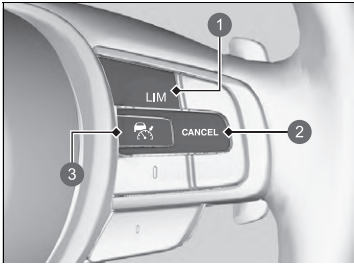

To cancel the intelligent speed limiter, do any of the following:

- Press the **CANCEL** button.
- Press the  button.
- Press the **LIM** button.

- ① **LIM** Button
- ② **CANCEL** Button
- ③  Button

⌘ Exceeding the Speed Limit Temporarily

The beeper sounds when the vehicle speed goes higher than the set speed limit with the acceleration pedal depressed completely.

The intelligent speed limiter resumes working once the vehicle speed goes lower than the set speed limit.

⌘ To Cancel

The intelligent speed limiter changes into adaptive cruise control (ACC) with Low Speed Follow or adjustable speed limiter if the **LIM** button is pressed.

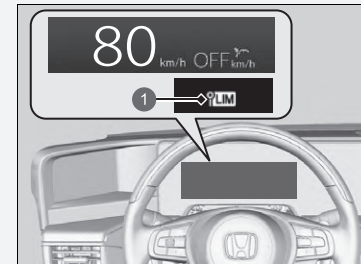

- ① Intelligent Speed Limiter Indicator (white)

If there is a problem with the system or traffic sign recognition system when you are using the intelligent speed limiter, the beeper sounds and **OFF** comes on. The intelligent speed limiter will be turned off.

▶ **Traffic Sign Recognition System** P. 486

Vehicle Stability Assist (VSA) System

VSA helps to stabilise the vehicle during cornering if the vehicle turns more or less than what was intended. It also assists in maintaining traction on slippery surfaces. It does so by regulating motor output and selectively applying the brakes.

■ VSA Operation

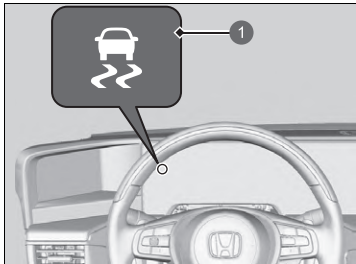

① VSA System Indicator

When VSA activates, you may notice that the motor does not respond to the accelerator. You may also notice some noise from the hydraulic system. You will also see the indicator blink.

⚠ Vehicle Stability Assist (VSA) System

The VSA may not function properly if tyre type and size are mixed. Make sure to use the same size and type of tyre, and the air pressures as specified.

When the VSA system indicator comes on and stays on while driving, there may be a problem with the system. While this may not interfere with normal driving, have your vehicle checked by a dealer immediately.



VSA cannot enhance stability in all driving situations and does not control the entire braking system. You still need to drive and corner at speeds appropriate for the conditions and always leave a sufficient margin of safety.

The main function of the VSA system is generally known as Electronic Stability Control (ESC). The system also includes a traction control function.

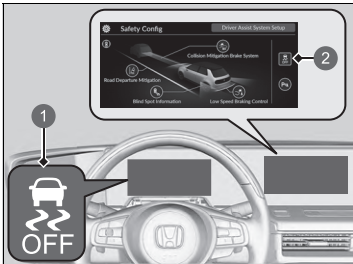
■ VSA On and Off



- ① VSA **OFF** Indicator
- ②  (VSA **OFF**) Icon

The  (VSA **OFF**) icon is in the safety config of the audio/information screen. To partially disable VSA functionality/features, press the  (VSA **OFF**) icon (green).

➤ **Driver Assist System On and Off** P. 322

Your vehicle will have normal braking and cornering ability, but traction control function will be less effective.

To restore VSA functionality/features, press the  (VSA **OFF**) icon (amber).

VSA is turned on every time you turn the power system on, even if you turned it off the last time you drove the vehicle.

▣ Vehicle Stability Assist (VSA) System

In certain unusual conditions when your vehicle gets stuck in shallow mud or fresh snow, it may be easier to free it with the VSA temporarily switched off.

When the VSA system is off, the traction control function becomes less effective. This allows for the wheels to spin more freely at low speed. You should only attempt to free your vehicle with the VSA off if you are not able to free it when the VSA is on.

Immediately after freeing your vehicle, be sure to switch VSA on again. We do not recommend driving your vehicle with the VSA system switched off.

You may hear a motor sound coming from under the bonnet while system checks are being performed immediately after turn the power system on or while driving. This is normal.

Deflation Warning System

Instead of directly measuring the pressure in each tyre, the deflation warning system on this vehicle monitors and compares the rolling radius and rotational characteristics of each wheel and tyre while you are driving to determine if one or more tyres are significantly under-inflated.

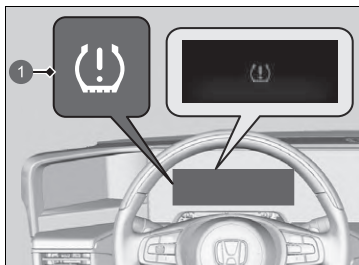

1 Low Tyre Pressure/Deflation Warning System Indicator

This will cause the low tyre pressure/deflation warning system indicator to come on and a message to appear on the driver information interface.

Deflation Warning System

The system does not monitor the tyres when driving at low speed.

Conditions such as low ambient temperature and altitude change directly affect tyre pressure and can trigger the low tyre pressure/deflation warning system indicator to come on.

Tyre pressure checked and inflated in:

- Warm weather can become under-inflated in colder weather.
- Cold weather can become over-inflated in warmer weather.

The Low Tyre Pressure/Deflation Warning System indicator will not come on as a result of over inflation.

The deflation warning system may not function properly if tyre type and size are mixed.

Make sure to use the same size and type of tyre.

➤ **Checking and Maintaining Tyres** P. 603

The low tyre pressure/deflation warning system indicator may come on with a delay or may not come on at all when:

- You rapidly accelerate, decelerate, or turn the steering wheel.
- You drive on snowy or slippery roads.
- Tyre chains are used.

■ Deflation Warning System Calibration

You must start deflation warning system calibration every time you:

- Adjust the pressure in one or more tyres.
- Rotate the tyres.
- Replace one or more tyres.

Before calibrating the deflation warning system:

- Set the cold tyre pressure in all four tyres.

➤ **Checking Tyres** P. 603

Make sure:

- The vehicle is at a complete stop.
- The transmission is in **P**.
- The power mode is in ON.

⌘ Deflation Warning System

The low tyre pressure/deflation warning system indicator may come on under the following conditions:

- Tyre chains are used.

⌘ Deflation Warning System Calibration

The calibration process requires approximately 30 minutes of cumulative driving at speeds between 40-100 km/h (25 - 62 mph).

During this period, if the power system is turned on and the vehicle is not moved within 45 seconds, you may notice the low tyre pressure indicator comes on briefly. This is normal and indicates that the calibration process is not yet complete.

If the tyre chains are installed, remove them before calibration the deflation warning system.

If the low tyre pressure/deflation warning system indicator comes on even when the properly inflated specified regular tyres are installed, have your vehicle checked by a dealer.

We recommend that the tyres be replaced with the same brand, model, and size as the originals. Ask a dealer for details.

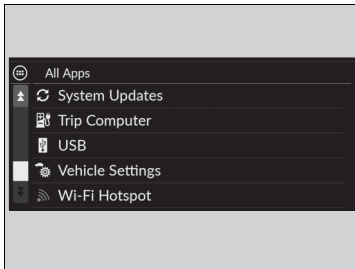

You can calibrate the system from the customized feature on the audio/information screen.

1. Set the power mode to ON.
2. Select **All Apps**.

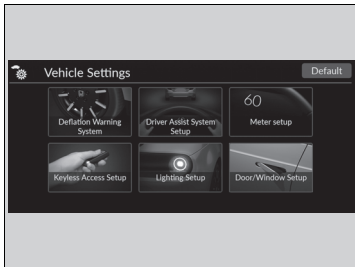

3. Select **Vehicle Settings**.

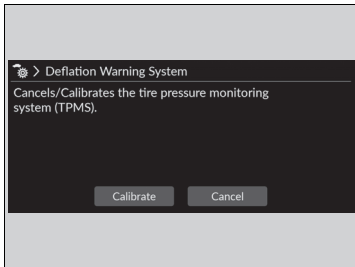

4. Select **Deflation Warning System**.
5. Select **Cancel** or **Calibrate**.

- If the **Calibration Failed to Start** message appears, repeat step 5.
- The calibration process finishes automatically.

Blind spot information System

Is designed to detect vehicles in specified alert zones adjacent to your vehicle, particularly in harder to see areas commonly known as “blind spots.”

When the system detects vehicles approaching from behind in adjacent lanes, the appropriate indicator comes on for a few seconds, providing assistance when you change lanes.

Blind spot information System

⚠ WARNING

Failure to visually confirm that it is safe to change lanes before doing so may result in a crash and serious injury or death. Do not rely only on the blind spot information system when changing lanes.

Always look in your mirrors, to either side of your vehicle, and behind you for other vehicles before changing lanes.

Important Safety Reminder

Like all assistance systems, blind spot information system has limitations. Over reliance on blind spot information system may result in a collision.

■ How the system works

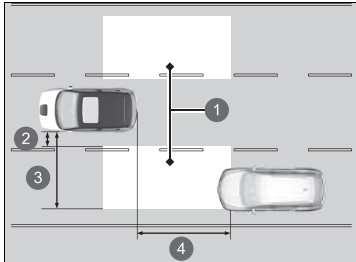



- ① Alert zone
- ② Approx. 0.5 m (1.6 ft.)
- ③ Approx. 3 m (10 ft.)
- ④ Approx. 3 m (10 ft.)

- Radar sensors detect a vehicle in the alert zone when your vehicle is moving forward at 20 km/h (12 mph) or faster.

Radar Sensors: underneath the rear bumper corners

▶▶ Blind spot information System

The system is for your convenience only. Even if an object is within the alert zone, the following situations may occur.

- The blind spot information system alert indicator may not come on due to obstruction (splashes, etc.) even without the  driver information interface appearing.
- The blind spot information system alert indicator may come on even with the  message appearing.

The blind spot information system alert indicator may not come on under the following conditions:

- A vehicle does not stay in the alert zone for more than two seconds.
- A vehicle is parked in a side lane.
- The speed difference between your vehicle and the vehicle you are passing is greater than 10 km/h (6 mph).
- An object not detected by the radar sensors approaches or passes your vehicle.
- A vehicle running in the adjacent lane is a motorcycle or other small vehicle.

You can turn off the audible alert, or all the blind spot information system alert using the audio/information screen.

 **Customized Features** P. 323

■ When the system detects a vehicle

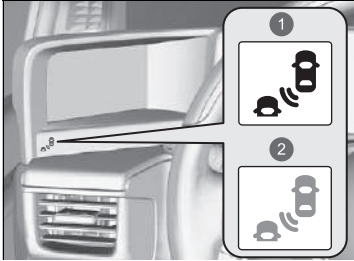

- ① Comes On
- ② Blinks

Blind spot information System Alert Indicator:
Located under the side camera mirror system display.

Comes on when:

- A vehicle enters the alert zone from behind to overtake you with a speed difference of no more than 50 km/h (31 mph) from your vehicle.
- You pass a vehicle with a speed difference of no more than 20 km/h (12 mph).

Blinks and a beeper sounds when:

You move the turn signal lever in the direction of the detected vehicle. The beeper sounds three times.

▣ Blind spot information System

Blind spot information system may be adversely affected when:

- Objects (guard rails, poles, trees, etc.) are detected.
- An object that does not reflect radio waves well, such as a motorcycle, is in the alert zone.
- Driving on a curved road.
- A vehicle is moving from a far lane to the adjacent lane.
- The system picks up external electrical interference.
- The rear bumper or the sensors have been improperly repaired or the rear bumper has been deformed.
- The orientation of the sensors has been changed.
- In bad weather (rain, snow, and fog).
- Making a turn at an intersection.
- Driving on a bumpy road.
- Making a short turn that slightly tilts the vehicle.

For a proper blind spot information system operation:

- Always keep the rear bumper corner area clean.
- Do not cover the rear bumper corner area with labels or stickers of any kind.
- Take your vehicle to a dealer if you need the rear bumper corner area or the radar sensors to be repaired, or the rear bumper corner area is strongly impacted.



■ Blind spot information On and Off

You can switch the system on and off from the audio/information screen.

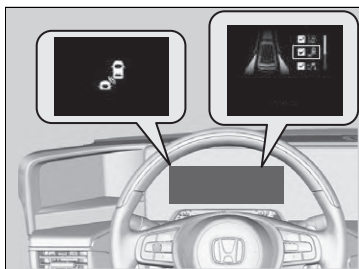
➤ **Driver Assist System On and Off** P. 322



You can also turn the system on and off by the following procedure:

1. Press the  button on the steering wheel.
2. Roll the left selector wheel and select **Safety Support**, then press the left selector wheel.
3. Roll the left selector wheel and select **Blind Spot Information System**, then press the left selector wheel.
 - ▶ The message appears on the driver information interface when the system becomes on or off.
 - ▶ A tick appears in the box and the colour of the  symbol changes green when the system is on. The tick disappear and the colour of the  symbol changes gray when the system is off.

Honda Sensing is a driver support system which employs the use of three distinctly different kinds of sensors:

A radar sensor located in the front grille, a front sensor camera mounted to the interior side of the windscreen, behind the rearview mirror, the sonar sensors located in the front and rear bumper.

Honda Sensing has following functions.

■ The functions which do not require switch operations to activate

- Collision Mitigation Braking System (CMBS) 📄 P. 428
- Low Speed Braking Control 📄 P. 439
- Road Departure Mitigation System 📄 P. 476
- Lead Car Departure Notification System 📄 P. 482
- Traffic Sign Recognition System 📄 P. 486

■ The functions which require switch operations to activate

- Adaptive Cruise Control (ACC) with Low Speed Follow 📄 P. 445
- Lane Keeping Assist System (LKAS) 📄 P. 465

■ Operation Switches for the ACC with Low Speed Follow/LKAS

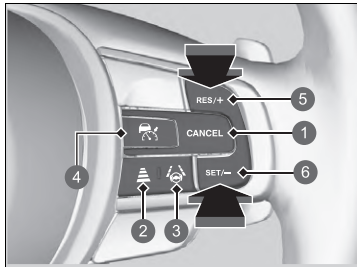

- 1 **CANCEL** Button
- 2 Interval Button
- 3 LKAS Button
- 4  Button
- 5 **RES/+** Button
- 6 **SET/-** Button

■ Button

Press to activate standby mode for ACC with Low Speed Follow.
Or press to cancel this system.

■ **LKAS** Button

Press to activate standby mode for LKAS.
Or press to cancel this system.

■ **RES/+**/**SET/-** Button

Press **RES/+** to resume the ACC with Low Speed Follow or increase the vehicle speed.
Press **SET/-** to set the ACC with Low Speed Follow or decrease the vehicle speed.

■ **Interval** Button

Press to change the ACC with Low Speed Follow following-interval.

■ **CANCEL** Button

Press to cancel ACC with Low Speed Follow.

Driver Information Interface Content

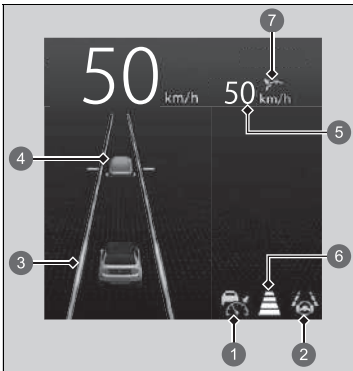

You can see the current state of ACC with Low Speed Follow and LKAS.

① Indicates that ACC with Low Speed Follow is ready to be activated.

- Green: The system is on.
- White: The system is standby.
- Amber: There is a problem with the system.

② Indicates that LKAS, is ready to be activated.

- Green: The system is on or standby.
- Amber: There is a problem with the system.

③ Indicates that LKAS is activated.

④ Indicates whether or not ACC with Low Speed Follow detected the vehicle ahead.

⑤ Indicates that ACC with Low Speed Follow shows the set vehicle speed.

⑥ Indicates that ACC with Low Speed Follow shows the set vehicle interval.

⑦ Indicates that ACC with Low Speed Follow shows the setting status.

- Green: The system is on.
- Gray: The system is not activated.

Collision Mitigation Braking System (CMBS)

Can assist you when there is a possibility of your vehicle colliding with a vehicle, pedestrian on foot or riding a bicycle (moving bicycle) detected in front of yours. The CMBS is designed to alert you when a potential collision is determined, as well as assist in reducing speed, avoiding collisions, and reducing collision severity.

Collision Mitigation Braking System (CMBS)

For directions on the proper handling of the radar sensor, refer to the following page.

➤ **Radar Sensor** P. 494

You can read about handling information for the camera equipped with this system.

➤ **Front Sensor Camera** P. 492

Important Safety Reminder

The CMBS is designed to reduce the severity of an unavoidable collision. It does not prevent collision nor stop the vehicle automatically. It is still your responsibility to operate the brake pedal and steering wheel appropriately according to the driving conditions.

The CMBS may not activate or may not detect a vehicle in front of your vehicle under certain conditions:

➤ **CMBS Conditions and Limitations** P. 433

■ How the system works

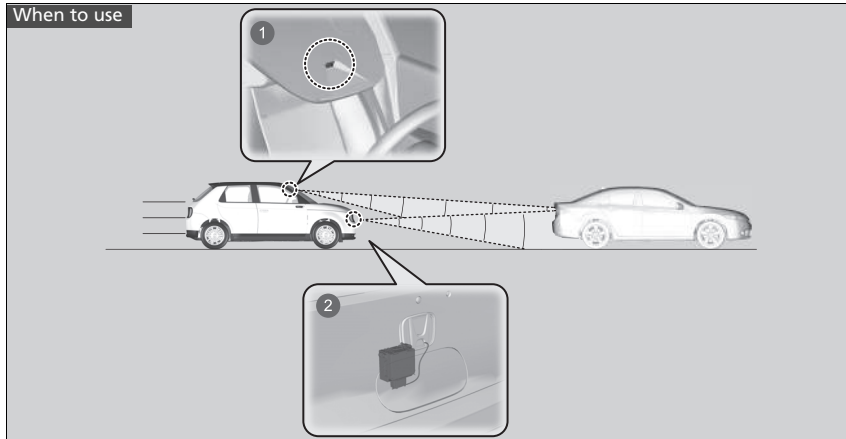

- ❶ The camera is located behind the rearview mirror.
- ❷ The radar sensor is located in the front grille.

The system starts monitoring the roadway ahead when your vehicle speed is about 5 km/h (3 mph) and there is a vehicle, pedestrian or moving bicycle in front of you.

⊠ Collision Mitigation Braking System (CMBS)

When the CMBS activates, it may automatically apply the brake. It will be cancelled when your vehicle stops or a potential collision is not determined.

The CMBS activates when:

- The speed difference between your vehicle and a vehicle, pedestrian or moving bicycle detected in front of you becomes about 5 km/h (3 mph) and over with a chance of a collision.
- Your vehicle speed is about 100 km/h (62mph) or less and the system determines there is a chance of a collision with:
 - An oncoming or stationary vehicle detected in front of you.
 - A pedestrian or moving bicycle detected in front of you.
- Your vehicle speed is above 100 km/h (62 mph), and the system determines there is a chance of a collision with a vehicle detected in front of you travelling in your same direction.

The CMBS will be canceled when your vehicle stops or a potential collision is not determined.

■ When the system activates

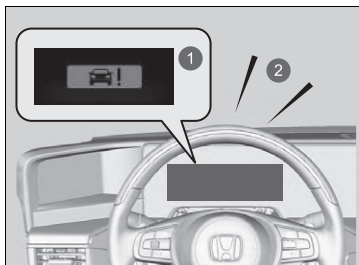

- ① Visual Alerts
- ② Audible Alert

The system provides visual and audible alerts of a possible collision, and stops if the collision is avoided.

- ▶ Take appropriate action to prevent a collision (apply the brakes, change lanes, etc.)

At system's earliest collision alert stage, you can change the distance (**Far/Normal/Near**) between vehicles at which alerts will come on through audio/information screen setting options.

- ▶ **Customized Features** P. 323

▶ When the system activates



The camera in the CMBS is also designed to detect pedestrians.

However, this pedestrian detection feature may not activate or may not detect a pedestrian in front of your vehicle under certain conditions. Refer to the ones indicating the pedestrian detection limitations from the list.

- ▶ **CMBS Conditions and Limitations** P. 433

■ Collision Alert Stages

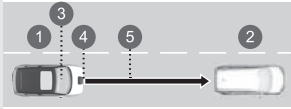
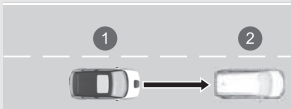
The system has three alert stages for a possible collision. However, depending on circumstances, the CMBS may not go through all of the stages before initiating the last stage.

Distance between vehicles	CMBS		
	The radar sensor detects a vehicle	Audible & Visual WARNINGS	Braking
Stage one 	There is a risk of a collision with the vehicle ahead of you.	When in Far , visual and audible alerts come on at a longer distance from a vehicle ahead than in Normal setting, and in Near , at a shorter distance than in Normal .	—
Stage two 	The risk of a collision has increased, time to respond is reduced.	Visual and audible alerts.	Lightly applied
Stage three 	The CMBS determines that a collision is unavoidable.		Forcefully applied

- ① Your Vehicle
- ② Vehicle Ahead
- ③ Far
- ④ Normal
- ⑤ Near



■ CMBS On and Off

You can switch the system on and off from the audio/information screen.

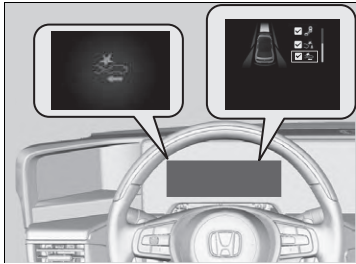
▶ **Driver Assist System On and Off** P. 322



You can also turn the system on and off by the following procedure:

1. Press the  button on the steering wheel.
2. Roll the left selector wheel and select **Safety Support**, then press the left selector wheel.
3. Roll the left selector wheel and select **Collision Mitigation Braking System**, then press the left selector wheel.
 - ▶ The message appears on the driver information interface when the system becomes on or off.
 - ▶ A tick appears in the box and the colour of the  symbol changes green when the system is on. The tick disappear and the colour of the  symbol changes gray when the system is off.

The CMBS is turned on every time you start the power system, even if you turned it off the last time you drove the vehicle.

▶▶ CMBS On and Off

The CMBS may automatically shut off, and the safety support indicator will come and stay on under certain conditions:

▶ **CMBS Conditions and Limitations** P. 433

When the CMBS is activated, it will continue to operate even if the accelerator pedal is partially depressed. However, it will be cancelled if the accelerator pedal is deeply depressed.

■ CMBS Conditions and Limitations

In the following situations, the radar sensor or camera may be unable to correctly detect vehicles, pedestrians, moving bicycles, or road conditions, potentially causing the CMBS to operate improperly.

📷 Front Sensor Camera P. 492

■ Environmental conditions

- Driving in bad weather (rain, fog, snow, etc.).
- Sudden changes between light and dark, such as an entrance or exit of a tunnel.
- There is little contrast between objects and the background.
- Driving into low sunlight (e.g., at dawn or dusk).
- Strong light is reflected onto the pedestrians, moving bicycles or roadway.
- Driving in the shadows of trees, buildings, etc.
- Roadway objects or structures are misinterpreted as vehicles and pedestrians.
- Reflections on the interior of the windscreen.
- Driving at night or in a dark place such as a tunnel (due to low-light conditions, pedestrians, moving bicycles or other vehicles may not be detected).

■ Roadway conditions

- Driving on a snowy or wet roadway (obscured lane marking, vehicle tracks, reflected lights, road spray, high contrast).
- Driving on curvy, winding, or undulating roads.
- The road is hilly or the vehicle is approaching the crest of a hill.

Driving on a narrow steel bridge or other area where there are objects that strongly reflect radio waves onto vehicles, pedestrians, or moving bicycles.

■ Vehicle conditions

- Headlight lenses are dirty or the headlights are not properly adjusted.
- The outside of the windscreen is blocked by dirt, mud, leaves, wet snow, etc.
- The inside of the windscreen is fogged.
- An abnormal tyre or wheel condition (wrong sized, varied size or construction, improperly inflated, etc.).
- When tyre chains are installed.
- The vehicle is tilted due to a heavy load or suspension modifications.
- The camera temperature gets too high.
- Driving with the electric parking brake applied.
- When the radar sensor in the front grille gets dirty.
- The vehicle is towing a trailer.
- Driving at night or in a dark place (e.g., a tunnel) with the headlights off.

■ Detection limitations

- A vehicle, moving bicycle or pedestrian suddenly crosses in front of you.
- The distance between your vehicle and the vehicle, moving bicycle or pedestrian ahead of you is too short.
- A vehicle cuts in front of you at a slow speed, and it brakes suddenly.
- When you accelerate rapidly and approach the vehicle, moving bicycle or pedestrian ahead of you at high speed.
- The vehicle ahead of you is a motorcycle, bicycle, mobility scooter or other small vehicle.
- When there are animals in front of your vehicle.
- When you drive on a curved, winding or undulating road that makes it difficult for the sensor to properly detect a vehicle in front of you.
- The speed difference between your vehicle and a vehicle, moving bicycle or pedestrian in front of you is significantly large.
- The vehicle ahead of you, oncoming vehicle, pedestrian, or moving bicycle suddenly cuts in front of or jumps out in front of you.
- Another vehicle suddenly comes in front of you at an intersection, etc.

- Your vehicle abruptly crosses over in front of an oncoming vehicle.
- When driving through a narrow iron bridge.
- When the lead vehicle suddenly slows down.
- The bicycle is stopped.
- The oncoming vehicle or vehicle ahead of you is sideways or facing diagonally.
- When a pedestrian or bicycle crosses the road too quickly.
- A pedestrian or bicycle approaches from the opposite direction.
- When a pedestrian or bicycle blends in with the background, preventing the system from recognising them.
- When several pedestrians are moving ahead of you in a group.
- When several bicycles are moving ahead of you in a group.
- When a pedestrian is pushing a stroller or bicycle.
- The oncoming vehicle or vehicle ahead of you is not illuminated in the dark.

Limitations applicable to pedestrian detection only

- When there is a group of people in front of your vehicle walking together side by side.
- Surrounding conditions or belongings of the pedestrian alter the pedestrian's shape, preventing the system from recognizing that the person is a pedestrian.
- When the pedestrian is shorter than about 1 metre (3.3 feet) or taller than about 2 metres (6.5 feet) in height.
- When a pedestrian is bent over or squatting, or when their hands are raised or they are running.
- When the camera cannot correctly identify that a pedestrian is present due to an unusual shape (holding luggage, body position, size).

■ Examples of other limitations on detection or system operation

- When the vehicle ahead of you is a motorcycle, mobility chair, or other specially-shaped vehicle.
- When the vehicle ahead of you, oncoming vehicle, pedestrian or moving bicycle is not in front of the vehicle.
- The speed difference between your vehicle and the vehicle ahead of you, oncoming vehicle, pedestrian or moving bicycle is significantly large.
- When the vehicle or moving bicycle in front of you slows suddenly.
- When you approach the vehicle ahead of you, oncoming vehicle, pedestrians or moving bicycles while accelerating rapidly or operating the steering wheel.
- When the moving bicycle is a child-sized bicycle, folding bicycle, three-wheeler or other bicycle with small tyres, or a long bicycle like a tandem bicycle.
- When the camera cannot correctly identify that a pedestrian is present due to an unusual shape.

■ Automatic shutoff

The CMBS may automatically shut itself off and the safety support indicator (amber) comes and stays on when:

- The temperature inside the system is high.
- You drive off-road or on a mountain road, or curved and winding road for an extended period.
- An abnormal tyre condition is detected (wrong tyre size, flat tyre, etc.).
- The camera behind the rearview mirror, or the area around the camera, including the windscreen, gets dirty.

Once the conditions that caused CMBS to shut off improve or are addressed (e.g., cleaning), the system comes back on.

■ With Little Chance of a Collision

The CMBS may activate even when you are aware of a vehicle ahead of you, or when there is no vehicle ahead. Some examples of this are:

■ When Passing

Your vehicle approaches another vehicle ahead of you and you change lanes to pass.

■ At an intersection

Your vehicle approaches or passes another vehicle that is making a left or right turn.

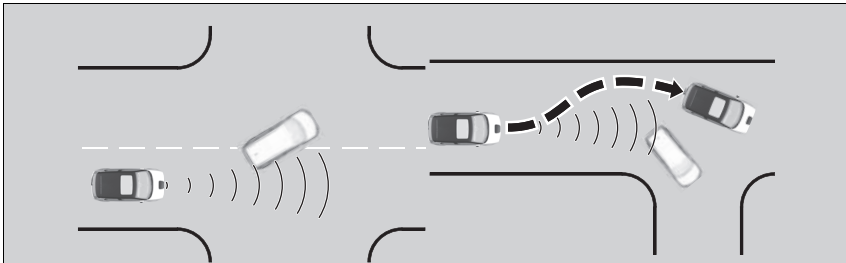

⚠ Collision Mitigation Braking System (CMBS)

Have your vehicle checked by a dealer if you find any unusual behaviour of the system (e.g., the warning message appears too frequently).

Continued

■ **On a curve**

When driving through curves, your vehicle comes to a point where an oncoming vehicle is right in front of you.

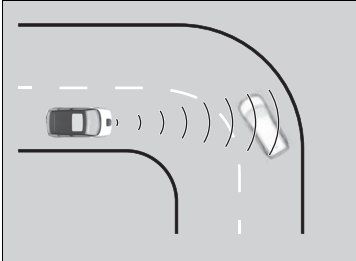

■ **Through a low bridge at high speed**

You drive under a low or narrow bridge at high speed.

■ **Speed bumps, road work sites, train tracks, roadside objects, etc.**

You drive over speed bumps, steel road plates, etc., or your vehicle approaches train tracks or roadside objects (such as a traffic sign and guard rail) on a curve or, when parking, stationary vehicles and walls.

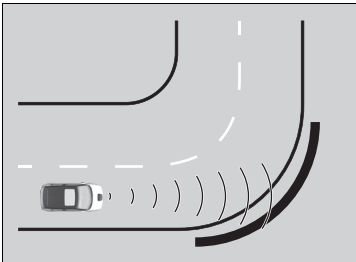

Low Speed Braking Control

The Low Speed Braking Control system has three functions: Low Speed Brake, Collision Mitigation Throttle Control, and Rear Collision Mitigation Throttle Control. Using sonar sensors located on the front and rear bumpers, the vehicle detects if there danger of collision with a wall or other obstacle when the accelerator is depressed with too much force, and the system assists in avoiding collisions and reducing damage from impact by limiting power system output.

Low Speed Braking Control

⚠ WARNING

It is not possible for the Low Speed Braking Control system to avoid collisions or reduce damage from collisions in all situations where the accelerator has been depressed accidentally or with too much force. Over reliance on this system may result in a collision and serious injury or death. It is your responsibility to always check your shift position, pedal location and surroundings, and safely operate the vehicle.

When trapped in a railway crossing, the system may detect the crossing gate as an obstacle and activate. If this happens, Low Speed Brake will automatically cancel after a certain amount of time after stopping, so continue to move forward. If Collision Mitigation Throttle Control is activated, continue to calmly depress the accelerator or depress the accelerator once again, then push aside the crossing gate.

If the system is activated by curbs/parking curbs or level differences on the road and you are unable to park or clear them, turn the system off.

Continued

■ How the System Works

Low Speed Brake function

The Low Speed Brake function provides a visual and audible alert when the vehicle is moving between approximately 2 and 10 km/h (1 and 6 mph) and there is the possibility of a collision with a wall or other obstacle, as well as providing assistance with braking.

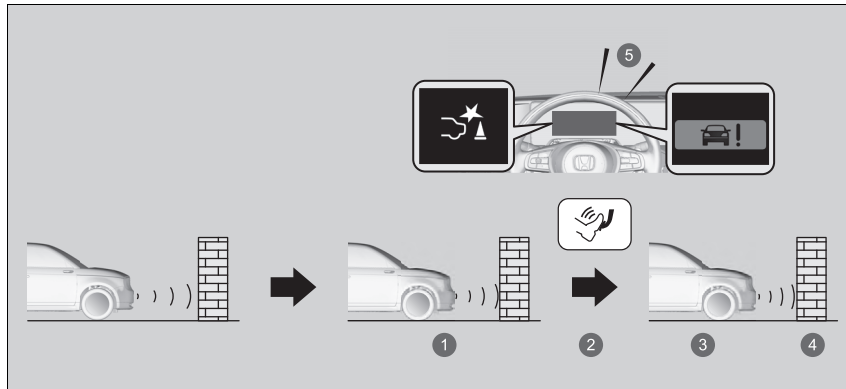

- ① Begin emergency braking
- ② Brake
- ③ Stop
- ④ Remove brake after maintaining stationary position
- ⑤ Audible Alert

▶▶ Low Speed Braking Control

For directions on the proper handling of the sonar sensors, please refer to the following page.

▶ **Sonar Sensors** P. 495

In order to prevent the system from activating when not needed, always turn it off during vehicle maintenance, when loading on ships, trucks, and so on, or when using a chassis dynamometer or free rollers for inspection.

Do not make any modifications to the suspension. The system may not operate correctly.

Always use the size and type of tyres recommended, make, and amount of wear. If these differ, the system may not operate correctly.

Collision Mitigation Throttle Control and Rear Collision Mitigation Throttle Control

When the vehicle is stopped or moving at less than 10 km/h (6 mph) and there is an obstacle such as a wall near the front of or back of the vehicle, if the accelerator is depressed more than necessary, the system will inform you with a visual and audible alert. At the same time, the system will prevent sudden forward or backwards movement by limiting the output of the power system, then Low Speed Brake will activate.

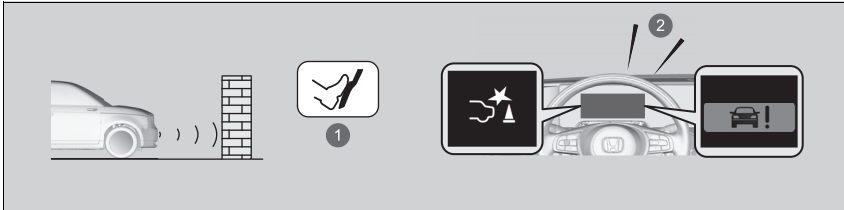

- ① Accidental depression of the accelerator/Limiting the output of the power system
- ② Audible Alert

Collision Mitigation Throttle Control and Rear Collision Mitigation Throttle Control will not activate in the following situations.

When moving forward:

When on a steep slope or the shift position is in **P**, **R**, or **N**.

When reversing:

When on a steep slope or the shift position is in a position other than **R**.



■ System On and Off

You can switch the system on and off from the audio/information screen.

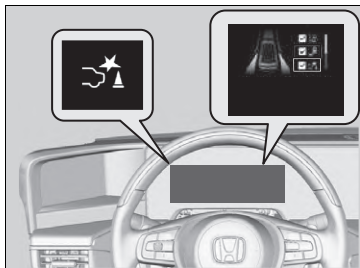
▶ **Driver Assist System On and Off** P. 322



You can also turn the system on and off by the following procedure:

1. Press the  button on the steering wheel.
2. Roll the left selector wheel and select **Safety Support**, then press the left selector wheel.
3. Roll the left selector wheel and select **Low Speed Braking Control**, then press the left selector wheel.
 - ▶ The message appears on the driver information interface when the system becomes on or off.
 - ▶ A tick appears in the box and the colour of the  symbol changes green when the system is on. The tick disappear and the colour of the  symbol changes gray when the system is off.

The low speed braking control system is turned on every time you start the power system, even if you turned it off the last time you drove the vehicle.

■ Conditions for Cancellation

Conditions for Collision Mitigation Throttle Control, and Rear Collision Mitigation Throttle Control.

- When the accelerator is no longer depressed.
- When the accelerator is depressed for approximately four seconds.
- When the brake pedal is depressed.
- When the steering wheel is turned and a collision avoided.

Conditions for Low Speed Brake function cancellation.

- A certain amount of time has passed since activation.

■ Low Speed Braking Control System Conditions and Limitations

The system may not operate correctly in the following conditions:

■ Examples of obstacles the sonar sensor cannot detect

- Obstacles that do not reflect sound waves well, such as people, snow, cloth, sponges, etc.
- Thin obstacles such as fences, bicycles, sign posts, etc.
- Short or small obstacles.
- Obstacles immediately in front of the bumper.
- Moving objects or obstacles that suddenly enter the road.
- Obstacles that are not perpendicular to the ground, such as a wall.

⌘ Conditions for Cancellation

After Low Speed Brake and Collision Mitigation Throttle Control have activated once, they will not activate again for the same obstacle. They can be activated again after driving for some time after the last activation.

Low Speed Brake and (Rear) Collision Mitigation Throttle Control activate separately when moving forward and reversing. (For example, if it activates when moving forward, it can be activated again immediately if reversing.) However, if Low Speed Brake has been activated, in order to activate Collision Mitigation Throttle Control again, it is necessary to drive for a certain amount of time.

■ **Examples of situations where the sonar sensor cannot detect obstacles**

- The sonar sensor is dirty (covered by snow, water, mud, etc.).
- The vehicle is too hot or cold.
- The steering wheel is turned sharply when approaching the obstacle at an angle.

■ **Examples of other cases where the system may not work correctly**

- The vehicle is tilted due to heavy luggage in the cargo space or rear seats.
- Bad weather conditions such as pouring rain, fog, snow, sandstorms, etc.
- The ambient temperature/humidity is too high or low.
- When going down a very steep slope.
- When close to other vehicles with sonar sensors or other objects that emit ultrasonic waves.

■ **Situations where the system may activate even without risk of a collision**

- When passing through short or narrow gates.
- When driving on uneven surfaces, grassy areas, or places with steps.
- When a sloped pillar or wall is protruding from a high position.
- When there are obstacles next to the road.
- When driving toward flags, curtains, tree branches, railroad crossing bars, etc.
- When driving on flooded roads.

Adaptive Cruise Control (ACC) with Low Speed Follow

Helps to maintain a constant vehicle speed and a set following-interval behind a vehicle detected ahead of yours and, if the detected vehicle comes to a stop, can decelerate and stop your vehicle, without you having to keep your foot on the brake or the accelerator.

When ACC with Low Speed Follow slows your vehicle by applying the brakes, your vehicle's brake lights will illuminate.

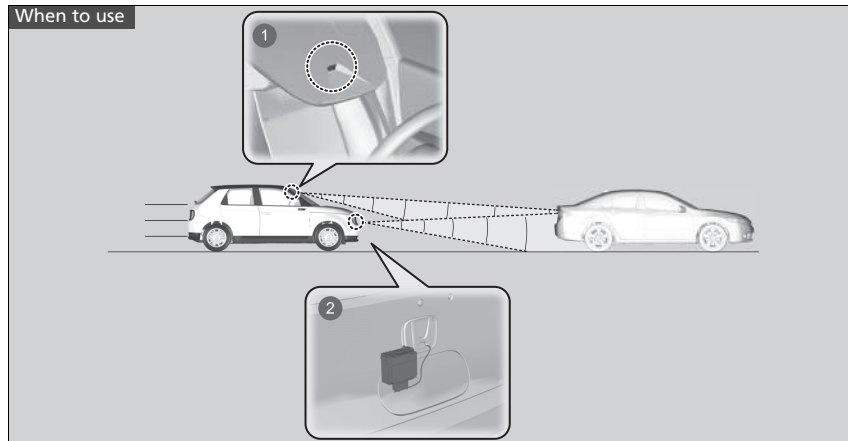

- ❶ The camera is located behind the rearview mirror.
- ❷ The radar sensor is located in the front grille.
Be careful not to hit the radar sensor cover. Strong impact can damage it.

Adaptive Cruise Control (ACC) with Low Speed Follow

⚠ WARNING

Improper use of ACC with Low Speed Follow can lead to a crash.

Use ACC with Low Speed Follow only when driving on motorways and in good weather conditions.

⚠ WARNING

ACC with Low Speed Follow has limited braking capability and may not stop your vehicle in time to avoid a collision with a vehicle that quickly stops in front of you.

Always be prepared to apply the brake pedal if the conditions require.

Important Reminder

As with any system, there are limits to ACC with Low Speed Follow. Use the brake pedal whenever necessary, and always keep a safe interval between your vehicle and other vehicles.

For directions on the proper handling of the radar sensor, refer to the following page.

➡ Radar Sensor P. 494

- Vehicle speed for ACC with Low Speed Follow: **The system can be used when a vehicle is detected ahead within ACC with Low Speed Follow range.**
No vehicle is detected within ACC with Low Speed Follow range – ACC with Low Speed Follow operates at the speed of 30 km/h (18 mph) or above.
- Shift position for ACC with Low Speed Follow: In **D**.

■ How to activate the system

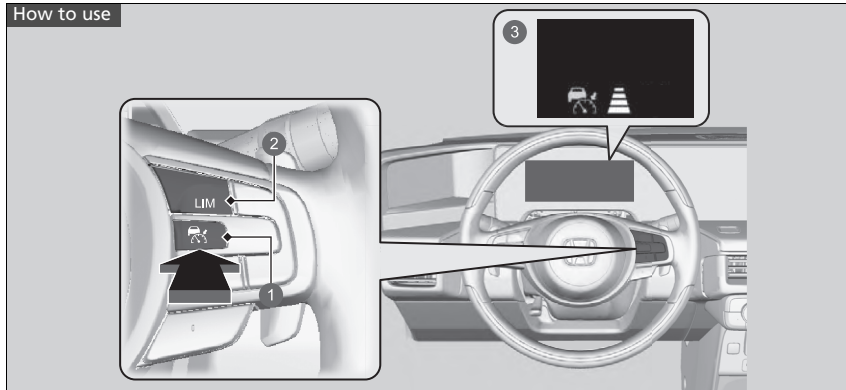

- 1 Button
Press the button on the steering wheel.
- 2 **LIM** Button
If a different indicator is displayed, press the **LIM** button to change it to ACC with Low Speed Follow.
- 3 (white) is on in the gauge. ACC with Low Speed Follow is ready to use.

▶ Adaptive Cruise Control (ACC) with Low Speed Follow

You can read about handling information for the camera equipped with this system.

▶ **Front Sensor Camera** P. 492

ACC with Low Speed Follow may not work properly under certain conditions.

▶ **ACC with Low Speed Follow Conditions and Limitations** P. 453

When not using ACC with Low Speed Follow: Turn off adaptive cruise by pressing the button.

Do not use ACC with Low Speed Follow under the following conditions:

- On roads with heavy traffic or while driving in continuous stop and go traffic.
- On roads with sharp turns.
- On roads with steep downhill sections, as the set vehicle speed can be exceeded by coasting. In such cases, ACC with Low Speed Follow will not apply the brakes to maintain the set speed.
- On roads with toll collection facilities or other objects between lanes of traffic, or in parking areas, or facilities with drive through access.

You can switch the displayed set speed measurements on the driver information interface or audio/information screen between km/h and mph.

▶ **Unit Change** P. 168

▶ **Customized Features** P. 323

■ To Set the Vehicle Speed

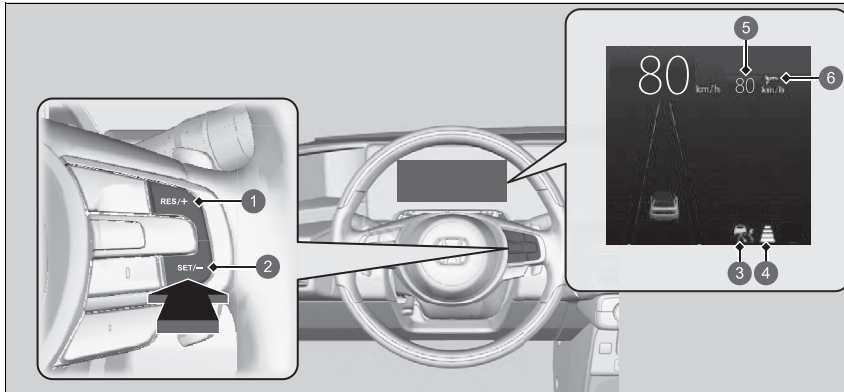

- 1 RES/+ Button
- 2 SET/- Button
- 3  (green)
- 4 Set Vehicle Interval
- 5 Set Vehicle Speed
- 6 Setting Status (green)

When driving at about 30 km/h (18 mph) or above: Take your foot off the pedal and press the **SET/-** button when you reach the desired speed. The moment you release the button, the set speed is fixed, and ACC with Low Speed Follow begins.

When driving slower than about 30 km/h (18 mph):

If the vehicle is moving and the brake pedal is not depressed, pressing the button fixes the set speed to 30 km/h (18 mph) regardless of current vehicle speed. If your vehicle is stationary, you can set the vehicle speed even with the brake pedal depressed.

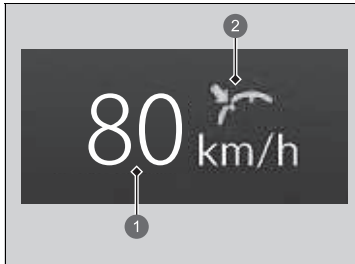

- ❶ Set Vehicle Speed (white)
- ❷ Setting Status (green)

When ACC with Low Speed Follow starts operating, set speed appear (green) on the gauge.

■ When in Operation

■ There is a vehicle ahead

ACC with Low Speed Follow monitors if a vehicle ahead of you enters the ACC with Low Speed Follow range. If a vehicle is detected doing so, the ACC with Low Speed Follow system maintains or decelerates your vehicle's set speed in order to keep the vehicle's set following interval from the vehicle ahead.

➔ **To Set or Change Following-interval** P. 457

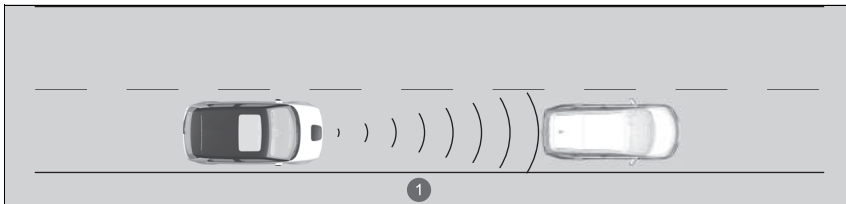

① ACC with Low Speed Follow Range: 120 m (394 ft.)

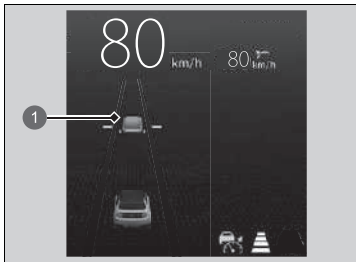

① A vehicle icon appears on the gauge

When a vehicle whose speed is slower than your set speed comes in or cuts in front of you and is detected by the radar and the camera, your vehicle starts to slow down.

⌘ When in Operation

If the vehicle ahead of you slows down abruptly, or if another vehicle cuts in front of you, the beeper sounds, a message appears on the driver information interface.

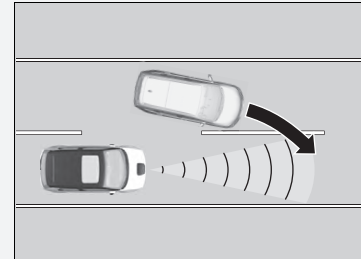

Depress the brake pedal, and keep an appropriate interval from the vehicle ahead.

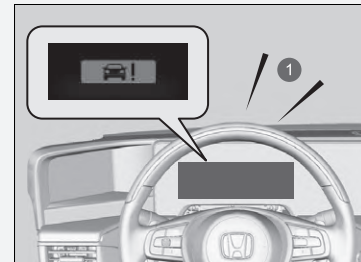

① Audible Alert

■ **There is no vehicle ahead**

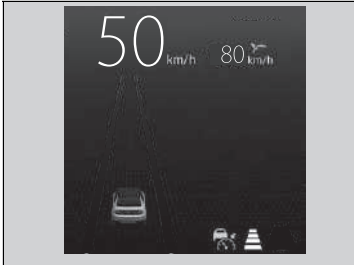

Your vehicle maintains the set speed without having to keep your foot on the brake or accelerator pedal.

If there previously was a vehicle detected ahead that kept your vehicle from travelling at the set speed, ACC with Low Speed Follow accelerates your vehicle to the set speed, and then maintains it.

■ **When you depress the accelerator pedal**

You can temporarily increase the vehicle speed. In this case, there is no audible or visual alert even if a vehicle is in the ACC with Low Speed Follow range. ACC with Low Speed Follow stays on unless you cancel it. Once you release the accelerator pedal, the system resumes an appropriate speed for keeping the following interval while a vehicle ahead is within the ACC with Low Speed Follow range.

⌘ **When in Operation**

Even if the interval between your vehicle and the vehicle detected ahead is short, ACC with Low Speed Follow may start accelerating your vehicle under the following circumstances:

- The vehicle ahead of you is going at almost the same speed as, or faster than, your vehicle.
- A vehicle that cuts in front of you is going faster than your vehicle, gradually increasing the interval between the vehicles.

You can also set the system to beep when a vehicle detected in front of you comes in and goes out of the ACC with Low Speed Follow detecting range.

Change the **ACC Vehicle Ahead Detected Beep** setting.

➤ **Customized Features** P. 323

Limitations

You may need to use the brake to maintain a safe interval when using ACC with Low Speed Follow. Additionally, ACC with Low Speed Follow may not work properly under certain conditions.

➤ **ACC with Low Speed Follow Conditions and Limitations** P. 453

■ A vehicle detected ahead is within ACC with Low Speed Follow range and slows to a stop

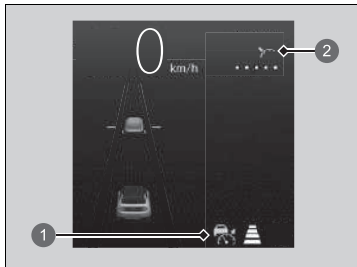

- 1 Adaptive Cruise Control (ACC) with Low Speed Follow Indicator (green)
- 2 Setting Status (green)

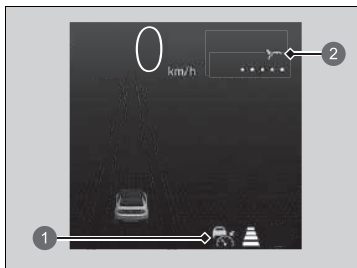

- 1 Adaptive Cruise Control (ACC) with Low Speed Follow Indicator (green)
- 2 Setting Status (green)

Your vehicle also stops automatically. The  message appears on the gauge. When the vehicle ahead of you starts again, if you press the **RES/+** or **SET/-** button, or depress the accelerator pedal, ACC with Low Speed Follow operates again within the previously set speed.

If no vehicle is ahead of you before you resume driving, depress the accelerator pedal and ACC with Low Speed Follow will operate again within the prior set speed.

When in Operation

⚠ WARNING

Exiting a vehicle that has been stopped while the ACC with Low Speed Follow system is operating can result in the vehicle moving without operator control.

A vehicle that moves without operator control can cause a crash, resulting in serious injury or death.

Never exit a vehicle when the vehicle is stopped by ACC with Low Speed Follow.

■ ACC with Low Speed Follow Conditions and Limitations

The system may automatically shut off and the Adaptive Cruise Control (ACC) with Low Speed Follow Indicator (amber) will come on under certain conditions. Some examples of these conditions are listed below. Other conditions may reduce some of the ACC functions.

📷 **Front Sensor Camera** P. 492

📷 **Radar Sensor** P. 494

■ Environmental conditions

- Driving in bad weather (rain, fog, snow, etc.).

■ Roadway conditions

- Driving on a snowy or wet roadway (obscured lane marking, vehicle tracks, reflected lights, road spray, high contrast).

■ Vehicle conditions

- The outside of the windscreen is blocked by dirt, mud, leaves, wet snow, etc.
- An abnormal tyre or wheel condition (Wrong sized, varied size or construction, improperly inflated, etc.).
- The camera temperature gets too high.
- The electric parking brake is applied.
- When the front grille is dirty.
- The vehicle is tilted due to a heavy load or suspension modifications.
- When tyre chains are installed.

📷 ACC with Low Speed Follow Conditions and Limitations

The radar sensor for ACC with Low Speed Follow is shared with the collision mitigation braking system (CMBS).

📷 Collision Mitigation Braking System (CMBS) P. 428

Always keep the radar sensor cover clean.

Never use chemical solvents or polishing powder for cleaning the sensor cover. Clean it with water or a mild detergent.

Do not put a sticker on the radar sensor cover or replace the radar sensor cover.

If you need the radar sensor to be repaired, or removed, or the radar sensor cover is strongly impacted, turn off the system by pressing the  button and take your vehicle to a dealer.

Have your vehicle checked by a dealer if you find any unusual behaviour of the system (e.g., the warning message appears too frequently).

■ Detection limitations

- A vehicle suddenly crosses in front of you.
- The interval between your vehicle and the vehicle ahead of you is too short.
- A vehicle cuts in front of you at a slow speed, and it brakes suddenly.
- When you accelerate rapidly and approach the vehicle ahead of you at high speed.
- The vehicle ahead of you is a motorcycle, bicycle, mobility scooter, or other small vehicle.
- When there are animals in front of your vehicle.
- When you drive on a curved or winding or undulating road that makes it difficult for the sensor to properly detect a vehicle in front of you.

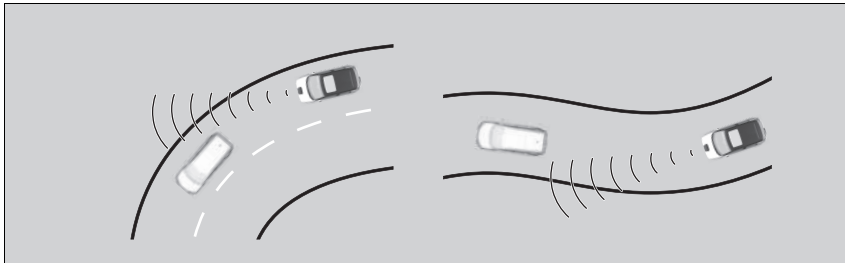

- The speed difference between your vehicle and a vehicle in front of you is significantly large.
- An oncoming vehicle suddenly comes in front of you.
- Your vehicle abruptly crosses over in front of an oncoming vehicle.

⚠ ACC with Low Speed Follow Conditions and Limitations

If the front of the vehicle is impacted in any of the following situations, the radar sensor may not work properly. Have your vehicle checked by a dealer:

- The vehicle impacted a bump, curb, chock, embankment, etc.
- You drive the vehicle where the water is deep.
- Your vehicle has a frontal collision.

- When driving through a narrow iron bridge.



- When the vehicle ahead of you brakes suddenly.
- When the vehicle ahead of you has a unique shape.

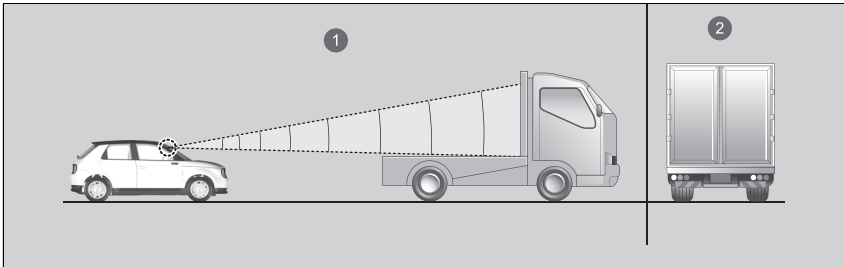

- ❶ Radar detects upper section of an empty carrier lorry.
- ❷ Panel lorry, tanker lorry, etc.
- When your vehicle or the vehicle ahead of you is driving on one edge of the lane.

■ To Adjust the Vehicle Speed

Increase or decrease the vehicle speed using the **RES/+** or **SET/-** button on the steering wheel.

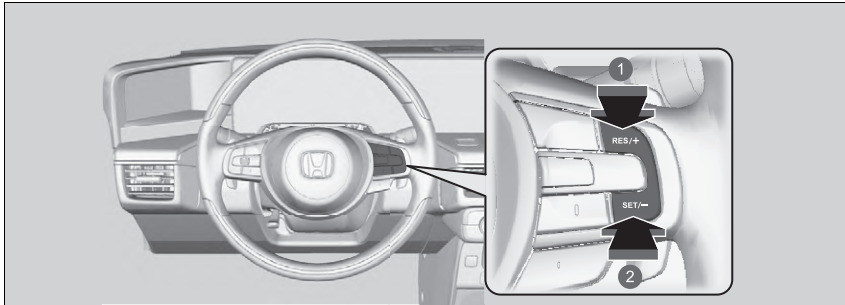

- ① To increase speed
 - ② To decrease speed
- Each time you press the **RES/+** or **SET/-** button, the vehicle speed is increased or decreased by about 1 km/h or 1 mph accordingly.
 - If you keep pressing the **RES/+** or **SET/-** button, the vehicle speed increases or decreases by about 10 km/h or 10 mph accordingly.

▶▶ To Adjust the Vehicle Speed

If a vehicle detected ahead is going at a speed slower than your increased set speed, ACC with Low Speed Follow may not accelerate your vehicle. This is to maintain the set interval between your vehicle and the vehicle ahead.

When you depress the accelerator pedal and then push and release the **SET/-** button, the current speed of the vehicle is set.

■ To Set or Change Following-interval

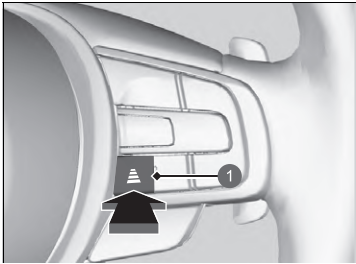



1 Interval Button

Press the interval button to change the ACC with Low Speed Follow following interval. Each time you press the button, the following-interval (the interval behind a vehicle detected ahead of you) setting cycles through extra long, long, middle, and short following-intervals.

Determine the most appropriate following-interval setting based on your specific driving conditions. Be sure to adhere to any following-interval requirements set by local regulation.

The higher your vehicle's following-speed is, the longer the short, middle, long or extra long following-interval becomes. See the following examples for your reference.

Following-interval		When the Set Speed is:	
		80 km/h (50 mph)	104 km/h (65 mph)
Short		24.2 metres 79.4 feet 1.1 sec	33.0 metres 108.2 feet 1.1 sec
Middle		33.0 metres 108.2 feet 1.5 sec	43.0 metres 141.0 feet 1.5 sec
Long		44.0 metres 144.3 feet 2.0 sec	57.5 metres 188.5 feet 2.0 sec
Extra Long		63.5 metres 208.3 feet 2.9 sec	83.4 metres 273.6 feet 2.9 sec

When your vehicle stops automatically because a vehicle detected ahead of you has stopped, the interval between the two vehicles will vary based on the ACC with Low Speed Follow interval setting.

⚠ To Set or Change Following-interval





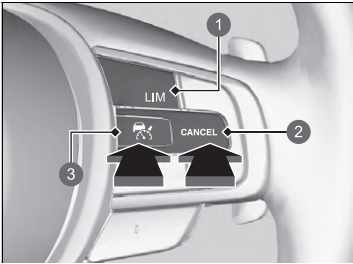

The driver must in all circumstances preserve a sufficient braking interval from the vehicle which precedes it and be aware that minimum intervals or times of spacing can be provided by the provisions of the Motorway Code locally applicable and that it is the driver's responsibility to respect those laws.

■ To Cancel





- ❶ LIM Button
- ❷ CANCEL Button
- ❸  Button

To cancel ACC with Low Speed Follow, do any of the following:

- Press the **CANCEL** button.
 - ▶ The  indicator (green) on the gauge change to the  indicator (white.)
- Press the  button.
 - ▶  indicator (green) goes off.
- Press the **LIM** button.
- Depress the brake pedal while the vehicle is moving forward.
 - ▶ The  indicator (green) on the gauge change to the  indicator (white.)

☒ To Cancel

The set speed cannot be set or resumed when ACC with Low Speed Follow has been turned off using the  button. Press the  button to activate the system, then set the desired speed.

Resuming the prior set speed: After you have cancelled ACC with Low Speed Follow, you can activate the ACC with Low Speed Follow with the prior set speed displayed on the meter (in gray) by pressing the **RES/+** button even if the vehicle is stopped.

When you turn the ACC with Low Speed Follow off by pressing the **CANCEL** button or depressing the brake pedal, the prior set speed is displayed on the meter in gray.

When pressing the **RES/+** button, the ACC with Low Speed Follow is activated with displayed speed.

Then, when the  white indicator is displayed and you press the **RES/+** button during the prior set speed (in gray) is not displayed, the current vehicle speed is set as same as the condition of operating the **SET/-** button.

■ Automatic cancellation

The beeper sounds and a message appears on the gauge when ACC with Low Speed Follow is automatically cancelled. Any of these conditions may cause the ACC with Low Speed Follow to automatically cancel:

- Bad weather (rain, fog, snow, etc.)
- When the radar sensor in the front grille gets dirty.
- The vehicle ahead of you cannot be detected.
- An abnormal tyre condition is detected, or the tyres are skidding.
- Driving on a mountainous road for extended periods, or driving off road.
- Abrupt steering wheel movement.
- When the ABS, VSA or CMBS is activated.
- When the ABS or VSA system indicator comes on.
- When the vehicle is stopped on a very steep slope.
- When you manually apply the electric parking brake.
- When the detected vehicle within the ACC with Low Speed Follow range is too close to your vehicle.
- The camera behind the rearview mirror, or the area around the camera, including the windscreen, gets dirty.
- When the Maximum Load Limit is exceeded.
- When passing through an enclosed space, such as tunnel.

The ACC with Low Speed Follow automatic cancellation can be also triggered by the following causes. In these cases, the electric parking brake will be automatically applied.

- The driver's seat belt is unfastened when the vehicle is stationary.
- The vehicle stops for more than 10 minutes.
- The power system is turned off.

▶▶ To Cancel

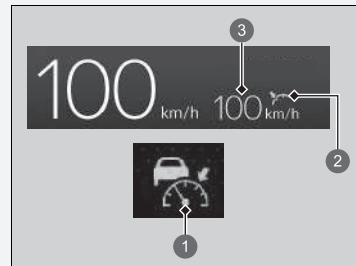

- ① (white)
- ② Setting Status (gray)
- ③ Prior Set Speed (gray)

▶▶ Automatic cancellation

Even though ACC with Low Speed Follow has been automatically cancelled, you can still resume the prior set speed. Wait until the condition that caused ACC with Low Speed Follow to cancel improves, then press the **RES/+** or **SET/-** button.

In the following cases, a buzzer sounds, ACC is deactivated, and the  message appears in the driver information interface.

- The vehicle has repeatedly applied the brakes to maintain the set speed (for example, you are descending a long slope).

■ Intelligent Adaptive Cruise Control Function

Provides an early prediction for a cut-in situation. The system detects that a vehicle running in the adjacent slower lane has an intention to cut in front of you and adjusts the speed of your vehicle in advance while ACC with Low Speed Follow is activated.

■ How the system works

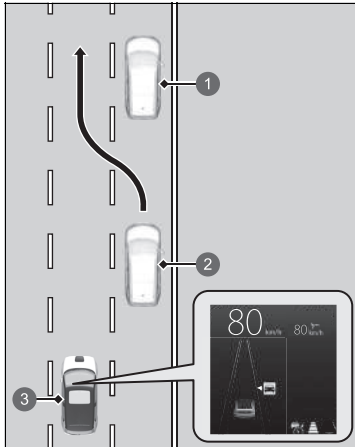

Left-hand drive type is shown.

- ❶ Slow Vehicle
- ❷ Cut-in Vehicle
- ❸ Your Vehicle

The radar sensor in the front grille detects vehicles ahead of you including those in the adjacent lane, and the camera behind the rearview mirror detects the lane markings.

This system improves ACC with Low Speed Follow's following/tracking property; it adjusts your vehicle speed in advance predicting a situation that a vehicle running in the adjacent slower lane catches up with a slower vehicle ahead of it and changes the lane to cut in front of you early.

When such a cut-in situation is predicted, your vehicle speed decreases a little. When detected, your vehicle speed decreases according to the vehicle cutting in front of you.

As the speed is adjusted by the system, the cut in vehicle icon appears on the gauge to indicate that the system is activated.

■ How the system activates

When a vehicle cuts in front of you is going faster than the vehicle ahead of it, and your vehicle is going faster than the cut-in vehicle (i.e., when you need to slow down), ACC with Low Speed Follow predicts the cutting-in and adjust your vehicle speed.

The system activates when all the following conditions are met:

- When ACC with Low Speed Follow is activated.
- When you are driving on a multi-lane road.
- When your vehicle speed is between about 80 km/h (50 mph) and about 145 km/h (90 mph).
- The vehicle is on a straight or slightly curved road.
- The turn signals are off.
- The brake pedal is not depressed.
- When a vehicle cuts in from a slower lane.

■ Intelligent adaptive cruise control on and off

You can turn the system on and off using the gauge or the audio/information screen.

▶ **Customized Features** P. 323

▶ Intelligent Adaptive Cruise Control Function

When traffic changes from right hand side to left hand side, driving on a road where there is oncoming traffic for some distance automatically switches the lane to be detected from right to left.

Intelligent adaptive cruise control may not activate under the following conditions:

- When the speed difference between the cut-in vehicle and the vehicle ahead of it in the adjacent lane*1 is small
- When the speed difference between the cut-in vehicle and your vehicle is small (i.e., when speed adjustment is not required)
- When a vehicle simply cuts in front of your vehicle with no vehicle ahead in the adjacent lane*1
- When a vehicle cuts in from a faster lane*1

*1: Refers to a right hand lane for right hand traffic, left hand lane for left hand traffic.

Lane Keeping Assist System (LKAS)

Provides steering input to help keep the vehicle in the middle of a detected lane and provides tactile, audible and visual alerts if the vehicle is detected drifting out of its lane.

■ Steering input assist

The system applies torque to the steering to keep the vehicle between the left and right lane lines. The applied torque becomes stronger as the vehicle gets closer to either of the lane lines.

☒ Lane Keeping Assist System (LKAS)

Important Safety Reminders

The LKAS is for your convenience only. It is not a substitute for your vehicle control. The system does not work if you take your hands off the steering wheel or fail to steer the vehicle.

☒ Driver Information Interface Warning and Information Messages P. 130

Do not place objects on the instrument panel. Objects may reflect on the windscreen and prevent correct detection of the traffic lanes.

The LKAS only alerts you when lane drift is detected without a turn signal in use. The LKAS may not detect all lane markings or lane departures; accuracy will vary based on weather, speed, and lane marker condition.

It is always your responsibility to safely operate the vehicle and avoid collisions.

The LKAS is convenient when it is used on motorways or a dual carriage way.

The LKAS may not work properly or may work improperly under the certain conditions:

☒ LKAS Conditions and Limitations P. 472

You can read about handling information for the camera equipped with this system.

☒ Front Sensor Camera P. 492

■ **Tactile, audible and visual alerts**

Rapid vibrations on the steering wheel, audible and a warning display alert you that the vehicle is drifting out of a detected lane.

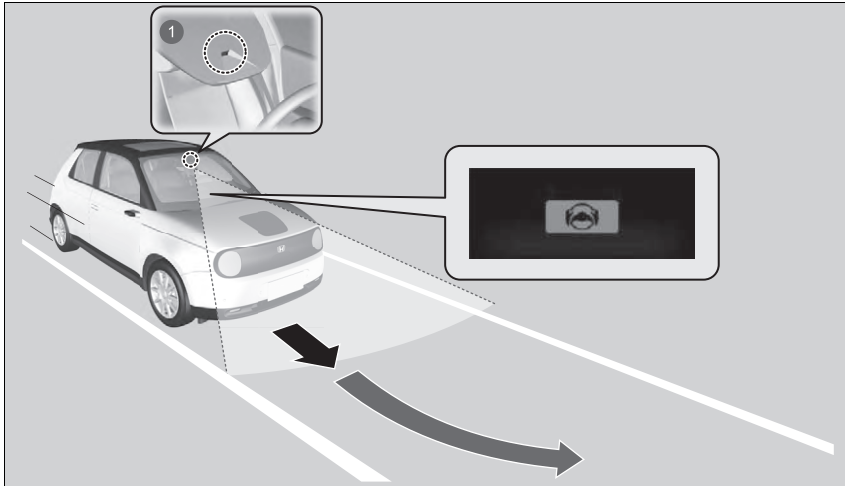

① Front sensor camera: Monitors the lane lines

When you operate the turn signals to change lanes, the system is suspended, and resumes after the signals are off.

If you make a lane change without operating the turn signals, the LKAS alerts activate.

■ Lane Keep Support Function

Provides assistance to keep the vehicle in the centre of the lane. When the vehicle nears a white or yellow line, steering force of the electric power steering will become stronger.

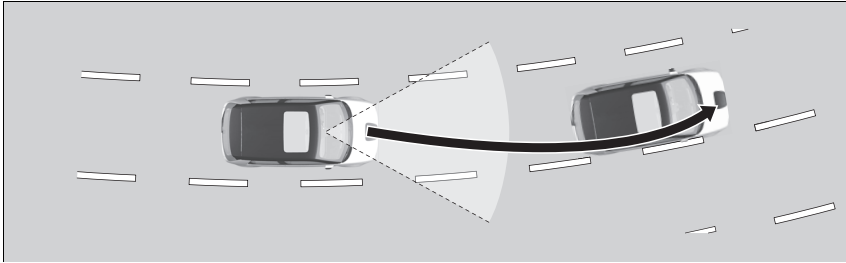

■ Lane Departure Warning Function

When the vehicle enters the warning area, the LKAS alerts you with slight steering wheel vibration, and audible and visual warnings.

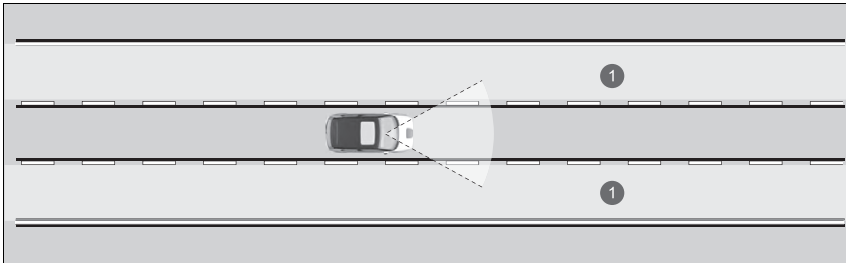

① Warning Area

☒ Lane Keeping Assist System (LKAS)

The LKAS may not function as designed while driving in frequent stop and go traffic, or on roads with sharp curves.

When it fails to detect lanes, the system will temporarily be cancelled. When a lane is detected, the system will recover automatically.

■ When the System can be Used

The system can be used when the following conditions are met.

- The lane in which you are driving has detectable lane markers on both sides, and your vehicle is in the centre of the lane.
- The vehicle is travelling at about 72 km/h (45 mph) or above.
- You are driving on a straight or slightly curved road.
- The turn signals are off.
- The brake pedal is not depressed.
- The wipers are not in high speed operation.

ⓘ When the System can be Used

If the vehicle drifts toward either left or right lane line due to the system applying torque, turn off the LKAS and have your vehicle checked by a dealer.

■ How to activate the system

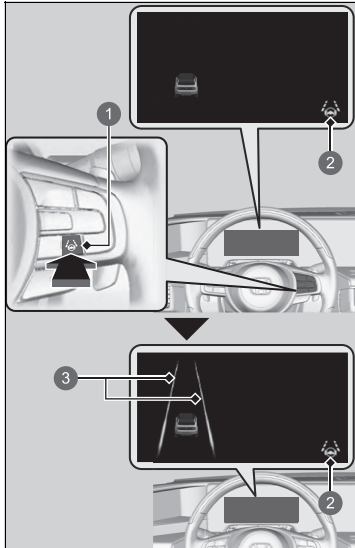

1. Press the LKAS button.
 - ▶ The icon is on in the gauge.
The system is ready to use.

2. Keep your vehicle near the centre of the lane while driving.
 - ▶ Lane appear on the gauge.
The system is activated.

- ① LKAS Button
- ② Lane Keeping Assist System (LKAS) Indicator (green)
- ③ Lane

■ To Cancel

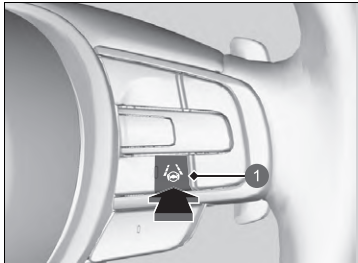

① LKAS Button

To cancel the LKAS:
Press the LKAS button.

The LKAS is turned off every time you turn the power system off, even if you turned it on the last time you drove the vehicle.



When the LKAS is suspended, the lane lines on the gauge change to frame lines, and the beeper sounds (if activated).

■ The system operation is suspended if you:

- Set the wipers to high speed.
 - ▶ Turning the wipers off or setting it to **LO** resumes the LKAS.
- Decrease the vehicle speed to about 64 km/h (40 mph) or less.
 - ▶ Increasing the vehicle speed to about 72 km/h (45 mph) or more resumes the LKAS.
- Your vehicle is driving to the right or the left of the lane.

■ **The LKAS may automatically be suspended when:**

- The system fails to detect lane lines.
 - The steering wheel is quickly turned.
 - You fail to steer the vehicle.
 - Driving through a sharp curve.
 - The Road Departure Mitigation System is activated.
- Once these conditions no longer exist, the LKAS automatically resumes.

■ **The LKAS may automatically be cancelled when:**

- The camera temperature gets extremely high or low.
- The camera behind the rearview mirror, or the area around the camera, including the windscreen, gets dirty.
- The ABS or VSA system engages.

The beeper sounds if the LKAS is automatically cancelled.

■ LKAS Conditions and Limitations

The system may not detect lane markings and therefore may not keep the vehicle in the middle of a lane under certain conditions, including the following:

■ Environmental conditions

- Driving in bad weather (rain, fog, snow, etc.).
- Sudden changes between light and dark, such as an entrance or exit of a tunnel.
- There is little contrast between lane lines and the roadway surface.
- Driving into low sunlight (e.g., at dawn or dusk).
- Strong light is reflected onto the roadway.
- Driving in the shadows of trees, buildings, etc.
- Shadows of adjacent objects are parallel to lane markings.
- Roadway objects or structures are misinterpreted as lane markers.
- Reflections on the interior of the windscreen.
- Driving at night or in a dark condition such as a tunnel.

■ Roadway conditions

- Driving on a snowy or wet roadway (obscured lane marking, vehicle tracks, reflected lights, road spray, high contrast).
- Driving on a road with temporary lane markings.
- Faint, multiple, or varied lane markings are visible on the roadway due to road repairs or old lane markings.

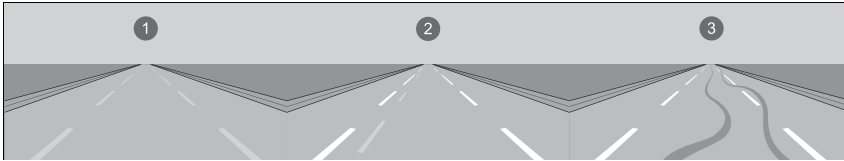

- ① Faded lines
- ② Duplicate lines
- ③ Tyre tracks

- The roadway has merging, split, or crossing lines (e.g., such as at an intersection or crosswalk).
- The lane markings are extremely narrow, wide, or changing.

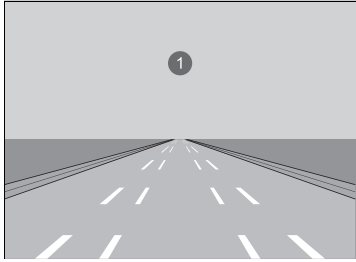

① Very wide or narrow traffic lane

- The vehicle in front of you is driving near the lane lines.
- The road is hilly or the vehicle is approaching the crest of a hill.
- Driving on rough or unpaved roads, or over bumpy surfaces.
- When objects on the road (curb, guard rail, pylons, etc.) are recognised as white lines (or yellow lines).
- Driving on roads with double lines.

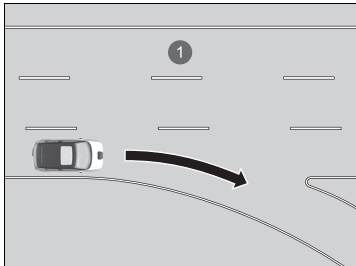

① Lane void of lines at junction

■ **Vehicle conditions**

- Headlight lenses are dirty or the headlights are not properly adjusted.
- The outside of the windscreen is streaked or blocked by dirt, mud, leaves, wet snow, etc.
- The inside of the windscreen is fogged.
- The camera temperature gets too high.
- An abnormal tyre or wheel condition (wrong sized, varied size or construction, improperly inflated, etc.).
- The vehicle is tilted due to a heavy load or suspension modifications.

Road Departure Mitigation System

Alerts and helps to assist you when the system detects a possibility of your vehicle unintentionally crossing over detected lane markings or the edge of the pavement, or leaving the roadway altogether.

How the System Works

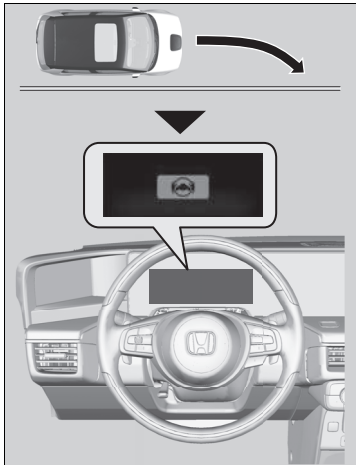

The front camera behind the rearview mirror monitors left and right lane markings (in white or yellow) and the outer edge of the pavement (bordered by grass or gravel). If your vehicle is getting too close to detected lane markings or the outer edge of the pavement (bordered by grass or gravel) without a turn signal activated, the system, in addition to a visual alert, applies steering torque and alerts you with rapid vibrations on the steering wheel, to help you remain within the detected lane.

If the system determines that the vehicle is about to veer off the edge of the pavement, it will alert the driver with an audible warning instead of steering wheel vibrations.

▶ **Customized Features** P. 323

As a visual alert,  message appears on the driver information interface.

▶▶ Road Departure Mitigation System

Important Safety Reminder

Like all assistance systems, the Road Departure Mitigation system has limitations.

Over-reliance on the Road Departure Mitigation system may result in a collision. It is always your responsibility to keep the vehicle within your driving lane.

The Road Departure Mitigation system only alerts you when lane drift is detected without a turn signal in use. The Road Departure Mitigation system may not detect all lane markings or lane or roadway departures; accuracy will vary based on weather, speed and lane marker condition. It is always your responsibility to safely operate the vehicle and avoid collisions.

You can read about handling information for the camera equipped with this system.

▶ **Front Sensor Camera** P. 492

The Road Departure Mitigation system may not work properly or may work improperly under the certain conditions:

▶ **Road Departure Mitigation Conditions and Limitations** P. 480

There are times when you may not notice Road Departure Mitigation system functions due to your operation of the vehicle, or road surface conditions.

If the system determines that its steering input is insufficient to keep your vehicle on the roadway, it may apply braking.

▶ Braking is applied only when the lane markings are solid continuous lines. The system cancels assisting operations when you turn the steering wheel to avoid crossing over detected lane markings.

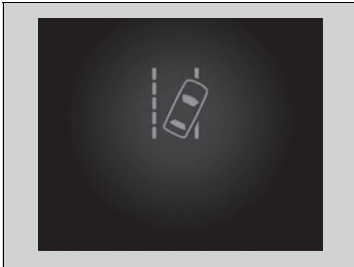

If the system operates several times without detecting driver response, the system beeps to alert you. After that, the Road Departure Mitigation steering assist is temporarily stopped, and the system will only alert you with the warning sound.

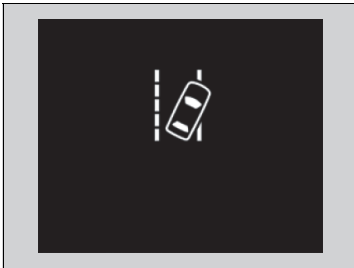

After a few minutes, the message to the left is displayed and the Road Departure Mitigation system is fully restored.

⌘ Road Departure Mitigation System

If LKAS is off and you have selected **Normal** or **Early** from the customised options using the driver information interface or audio/information screen, the message below will appear if the system has determined that there is a possibility of your vehicle crossing over detected lane markings or the outer edge of the pavement (into grass or gravel border). If you have selected **Delayed**, however, the message will only appear if the vehicle is about to cross over the outer edge of the pavement.

➤ **Customized Features** P. 323

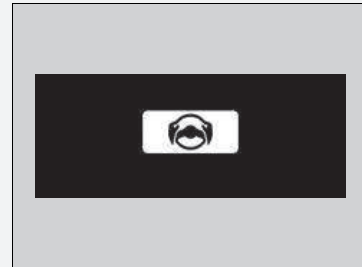

■ How the System Activates

The system becomes ready to start searching for lane markings when all the following conditions are met:

- The vehicle is travelling at about 65 km/h (40 mph) or above.
- The vehicle is on a straight or slightly curved road.
- The turn signals are off.
- The brake pedal is not depressed.
- The wipers are not in high speed operation.
- The vehicle is not accelerating or braking, and the steering wheel is not being turned.
- The system makes a determination that the driver is not actively accelerating, braking or steering.

▶▶ How the System Activates

The Road Departure Mitigation system may automatically shut off and the  indicator comes and stays on.

 **Indicators** P. 106

Road Departure Mitigation system function can be impacted when the vehicle is:

- Not driven within a traffic lane.
- Driven on the inside edge of a curve, or outside of a lane.
- Driven in a narrow lane.

■ Road Departure Mitigation On and Off

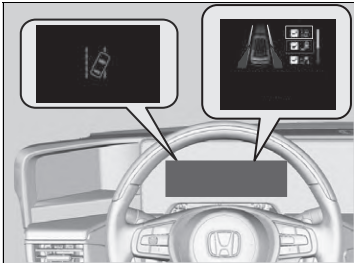

You can switch the system on and off from the audio/information screen.

📄 **Driver Assist System On and Off** P. 322



You can also turn the system on and off by the following procedure:

1. Press the  button on the steering wheel.
2. Roll the left selector wheel and select **Safety Support**, then press the left selector wheel.
3. Roll the left selector wheel and select **Road Departure Mitigation**, then press the left selector wheel.

- ▶ The message appears on the driver information interface when the system becomes on or off.
- ▶ A tick appears in the box and the colour of the  symbol changes green when the system is on. The tick disappear and the colour of the  symbol changes gray when the system is off.

The Road Departure Mitigation system is turned on every time you turn the power system on, even if you turned it off the last time you drove the vehicle.

■ Road Departure Mitigation Conditions and Limitations

The system may not properly detect lane markings and the position of your vehicle under certain conditions. Some examples of these conditions are listed below.

■ Environmental conditions

- Driving in bad weather (rain, fog, snow, etc.).
- Sudden changes between light and dark, such as an entrance or exit of a tunnel.
- There is little contrast between lane lines and the roadway surface.
- Driving into low sunlight (e.g., at dawn or dusk).
- Strong light is reflected onto the roadway.
- Driving in the shadows of trees, buildings, etc.
- Shadows of adjacent objects are parallel to lane markings.
- Roadway objects or structures are misinterpreted as lane markers.
- Reflections on the interior of the windscreen.
- Driving at night or in a dark condition such as a tunnel.
- The outer edge of the pavement is bordered by objects, material etc. other than grass or gravel.

■ Roadway conditions

- Driving on a snowy or wet roadway (obscured lane marking, vehicle tracks, reflected lights, road spray, high contrast).
- Driving on a road with temporary lane markings.
- Faint, multiple, or varied lane markings are visible on the roadway due to road repairs or old lane markings.
- The roadway has merging, split, or crossing lines (e.g., such as at an intersection or crosswalk).
- The lane markings are extremely narrow, wide, or changing.
- The vehicle in front of you is driving near the lane lines.
- The road is hilly or the vehicle is approaching the crest of a hill.
- Driving on rough or unpaved roads, or over bumpy surfaces.
- When objects on the road (curb, guard rail, pylons, etc.) are recognised as white lines (or yellow lines).
- Driving on roads with double lines.

■ Vehicle conditions

- Headlight lenses are dirty or the headlights are not properly adjusted.
- The outside of the windscreen is streaked or blocked by dirt, mud, leaves, wet snow, etc.
- The inside of the windscreen is fogged.
- The camera temperature gets too high.
- An abnormal tyre or wheel condition (wrong sized, varied size or construction, improperly inflated, etc.).
- The vehicle is tilted due to a heavy load or suspension modifications.
- When tyre chains are installed.

Lead Car Departure Notification System

Informs you with visual and audible alerts when your vehicle is stopped even though the vehicle ahead of you has started moving.

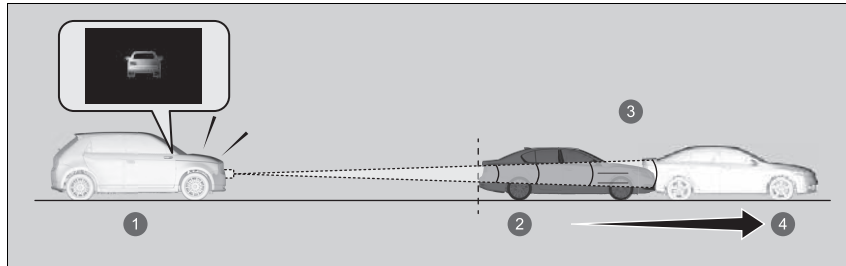

- 1 When stopped
- 2 Stopped
- 3 When start driving
- 4 Vehicle Ahead

How the system works

The system detects a stopped vehicle in front of you, on the condition that the vehicles are within 10 m (32 ft.) of each other and both vehicles have been stopped for a period of time. When the detected vehicle moves but yours does not, the system will activate.

When the shift position is in **D**

The system will work when the brake pedal is depressed, the brake hold function of the automatic brake hold system is in operation, or ACC with Low Speed Follow is in operation.

Lead Car Departure Notification System

WARNING

Lead Car Departure Notification System is an supplemental system that provides driving assistance. It is not a system that informs you if it is safe to start driving.

Improper use of this system may lead to a collision.

Always visually confirm the safety of your surroundings before driving the vehicle and maintain a safe following-interval when driving.

For directions on the proper handling of the radar sensor, refer to the following page.

▶ Radar Sensor P. 494

You can read about handling information for the camera located behind the rearview mirror.

▶ Front Sensor Camera P. 492

Like other assistance systems, this system may not function properly depending on weather, environmental conditions, and so on.

■ When the shift position is in N

The system will work when the vehicle is stopped, the brake pedal is depressed, the parking brake is in operation, or the brake hold function of the automatic brake hold system is in operation.

■ When the vehicle is stopped by Single Pedal Control

The hold function of the single pedal control is in operation.

You can choose from two system operation timing modes, **Normal** and **Early**.

➤ **Customized Features** P. 323

In Normal mode, the system operates when the vehicle ahead of you has moved approximately 3 m (9.8 ft.) from where it stopped.

In Early mode, the system operates as soon as movement has been detected.

☒ Lead Car Departure Notification System

You can turn off the Lead Car Departure Notification System.

➤ **Customized Features** P. 323

The Lead Car Departure Notification System will not activate while the Adaptive Cruise Control (ACC) with Low Speed Follow Indicator is on.

➤ **Adaptive Cruise Control (ACC) with Low Speed Follow** P. 445

■ When the System Activates

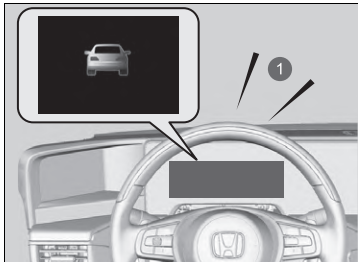

The beeper sounds and a message appears on the driver information interface when the system is activated.

① Audible Alert

■ Lead Car Departure Notification System Conditions and Limitations

In the following conditions, the system may or may not activate regardless of whether the vehicle ahead of you starts to move.

■ Examples of cases when the radar sensor cannot properly detect another vehicle due to vehicle condition

- The vehicle is tilted due to a heavy load or suspension modifications.
- The front grill is dirty.
- When the vehicle was only stopped for a short time.

■ Examples of cases when the radar sensor cannot properly detect another vehicle due to environmental conditions

- Weather conditions are poor (rain, fog, snow, etc.).
- Water or snow has been stirred up or sprayed by the vehicle ahead of you.

■ Examples of cases when the radar sensor cannot properly detect the vehicle ahead of you due to road conditions

- The road is curvy, winding, or sloping.
- There are objects around your vehicle that reflect radio waves strongly, such as when driving through a narrow iron bridge.

■ Examples of cases when the radar sensor cannot properly detect the vehicle ahead of you due to the conditions of the vehicle itself

- The vehicle ahead of you was only stopped for a short time.
- The space between your vehicle and the vehicle ahead of you is too short.
- The vehicle ahead of you is moving too slowly.
- The vehicle ahead of you turns right, left, or around suddenly.

■ Examples of cases when the radar sensor cannot properly detect the vehicle ahead of you due to other conditions

- There is a pedestrian, bicycle, or mobility scooter in front of your vehicle, or the vehicle ahead of you has a unique shape.
- Another vehicle, pedestrian or bicycle suddenly moves between your vehicle and the vehicle ahead of you.
- The vehicle ahead of you is not directly in front of you.

Traffic Sign Recognition System

Reminds you of road sign information, such as the current speed limit and that overtaking is prohibited, your vehicle has just passed through, showing it on the gauge.

How the System Works

When the camera located behind the rearview mirror captures traffic signs while driving, the system displays the ones that are recognised as designated for your vehicle. The sign icon will be displayed until the vehicle reaches a predetermined time and distance.

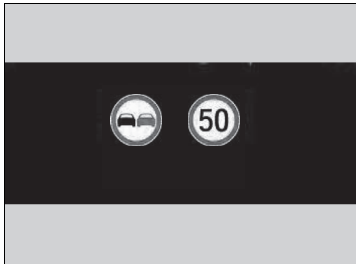

The sign icon also may switch to another one, or disappear when:

- The end of speed limit or other designated limit is detected.
- Your vehicle enters/exits motorway or highway.
- You make a turn with a turn signal at an intersection.

Traffic Sign Recognition System

The system is designed to detect signs that follow the Vienna Convention standards. Not all signs may be displayed, but any signs posted on roadsides should not be ignored. The system does not work on the designated traffic signs of all the countries you travel, nor in all situations.

Do not rely too much on the system. Always drive at speeds appropriate for the road conditions.

Never apply a film or attach any objects to the windscreen that could obstruct the camera's field of vision and cause the system to operate abnormally. Scratches, nicks, and other damage to the windscreen within the camera's field of vision can cause the system to operate abnormally. If this occurs, we recommend that you replace the windscreen with a genuine Honda replacement windscreen. Making even minor repairs within the camera's field of vision or installing an aftermarket replacement windscreen may also cause the system to operate abnormally. After replacing the windscreen, have a dealer recalibrate the camera. Proper calibration of the camera is necessary for the system to operate properly.

If the system does not detect any traffic signs while you are driving, the image below may appear.

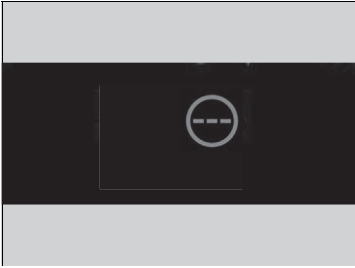

☒ Traffic Sign Recognition System

To help reduce the likelihood that high interior temperatures will cause the camera's sensing system to shut off, when parking, find a shady area or face the front of the vehicle away from the sun. If you use a reflective sun shade, do not allow it to cover the camera housing.

Covering the camera can concentrate heat on it.

You can read about handling information for the camera equipped with this system.

☒ **Front Sensor Camera** P. 492

The unit for speed limits (mph or km/h) varies from country to country. Just after entering a country whose unit differs to the one of the country from which you came, Traffic Sign Recognition System may not work correctly.

☒ **Unit Change** P. 168

☒ **Customized Features** P. 323

If your vehicle exceeds the detected speed limit, an icon representing the speed limit sign for the current area will blink in the display.

The system's ability to accurately notify the driver of the speed limit is dependent on certain conditions such as the units displayed on the traffic sign as well as the speed and direction of travel of the vehicle. In some cases, the system may display false warnings or other inaccurate information.

☒ **Traffic Sign Recognition System Conditions and Limitations** P. 488

Continued

■ Traffic Sign Recognition System Conditions and Limitations

The Traffic Sign Recognition system may incorrectly recognise, be slow to identify, or fail to recognise the traffic sign in the following cases.

■ Vehicle conditions

- Headlight lenses are dirty or the headlights are not properly adjusted.
- The outside of the windscreen is blocked by dirt, mud, leaves, wet snow, etc.
- The inside of the windscreen is fogged.
- There are portions remaining to be wiped.
- An abnormal tyre or wheel condition (wrong sized, varied size or construction, improperly inflated, etc.).
- The vehicle is tilted due to a heavy load or suspension modifications.

■ Environmental conditions

- Driving into low sunlight (e.g., at dawn or dusk).
- Strong light is reflected onto the roadway.
- Sudden changes between light and dark, such as an entrance or exit of a tunnel.
- When you drive in the shadows of trees, buildings, etc.
- Driving at night, in dark areas such as long tunnels.
- Driving in bad weather (rain, fog, snow, etc.).
- A vehicle in front of you is travelling flying up spray or snow.

▶ Traffic Sign Recognition System Conditions and Limitations

When the Traffic Sign Recognition System malfunctions,  appears on the gauge. If this message does not disappear, have your vehicle checked by a dealer.



■ The position or the condition of the traffic sign

- A sign is hard to be found since it is in a complicated area.
- A sign is located far away from your vehicle.
- A sign is located where the beam of the headlight is hard to reach.
- A sign is on a corner or bend in the road.
- Faded or bent signs.
- Rotated or damaged signs.
- A sign is covered with mud, snow, or frost.
- A part of the sign is hidden by the trees, or the sign itself is hidden by a vehicle and others.
- Light (a streetlight) or a shadow is reflected on the surface of the sign.
- A sign is too bright or too dark (an electric sign).
- A sign of a small size.

■ Other conditions

- When you are driving at a high speed.

The Traffic Sign Recognition System may not operate correctly, such as displaying a sign that does not follow the actual regulation for the roadway or does not exist at all in the following cases.

- ▶ A speed limit sign may display at a higher or lower speed than the actual speed limit.
- There is a supplementary sign with further information such as weather, time, vehicle type, etc.
- Figures on the sign are hard to read (electric signs, numbers on the sign are blurred etc.).
- A sign is in the vicinity of the lane you are driving even though it is not for the lane (speed limit sign situated at the junction between the side road and the main road, etc.).
- There are things that look similar to the colour or shape of the recognition object (similar sign, electric sign, signboard, structure, etc.).
- A lorry or another large vehicle with a sticker of the speed limit sign on the back are travelling in front of you.

■ Signs Displayed on the Gauge

Two traffic signs can be simultaneously displayed next to each other when detected. The speed limit sign icon is displayed on the right half of the screen. The overtaking prohibition sign icon appears on the left. Any additional sign that indicates speed limit based on weather (snow, etc.) or specific period of time can appear on either side.

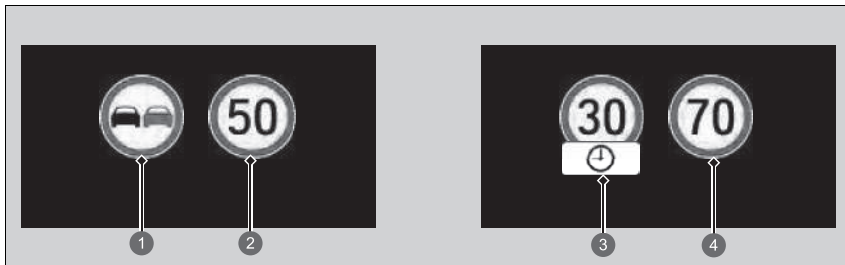

- ① Overtaking Prohibition Sign*1
- ② Speed Limit Sign
- ③ Additional Speed Limit Sign Based on Conditions*2
- ④ Speed Limit Sign

Depending on situation, *1 can be replaced with *2, or *2 can appear on the right side.

Front Sensor Camera

The camera, used in systems such as Lane Keeping Assist System (LKAS), Road Departure Mitigation System, Adaptive Cruise Control (ACC) with Low Speed Follow, Traffic Sign Recognition System, Lead Car Departure Notification System, and Collision Mitigation Braking System (CMBS), is designed to detect an object that triggers any of the systems to operate its functions.

■ Camera Location and Handling Tips

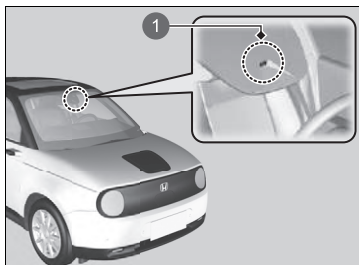

1 Front Sensor Camera

This camera is located behind the rearview mirror.

To help to reduce the likelihood that high interior temperatures will cause the camera's sensing system to shut off, when parking, find a shady area or face the front of the vehicle away from the sun. If you use a reflective sun shade, do not allow it to cover the camera housing. Covering the camera can concentrate heat on it.

⚠ Front Sensor Camera

Never apply a film or attach any objects to the windshield, the bonnet, or the front grille that could obstruct the camera's field of vision and cause the system to operate abnormally.

Scratches, nicks, and other damage to the windshield within the camera's field of vision can cause the system to operate abnormally. If this occurs, we recommend that you replace the windshield with a genuine Honda replacement windshield. Making even minor repairs within the camera's field of vision or installing an aftermarket replacement windshield may also cause the system to operate abnormally.

After replacing the windshield, have a dealer recalibrate the camera. Proper calibration of the camera is necessary for the system to operate properly.

Do not place an object on the top of the instrument panel. It may reflect onto the windshield and prevent the system from detecting lane lines properly.

⌘ Front Sensor Camera

If the  message appears:

- Use the climate control system to cool down the interior and, if necessary, also use demister mode with the air flow directed towards the camera.
- Start driving the vehicle to lower the windscreen temperature, which cools down the area around the camera.

If the  message appears:

- Park your vehicle in a safe place, and clean the windscreen. If the message does not disappear after you have cleaned the windscreen and driven for a while, have your vehicle checked by a dealer.

Radar Sensor

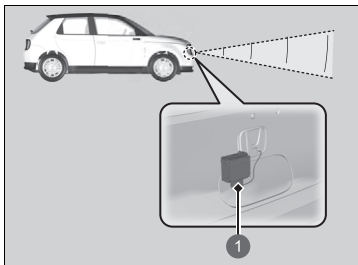

① Radar Sensor

The radar sensor is in the front grille.

⚠ Radar Sensor

For the system to work properly, observe the following precautions.

- Always keep the front grille clean.
- Never use chemical solvents or polishing powder for cleaning the front grille. Clean it with water or a mild detergent.
- Do not put any stickers or paint on the front grille.
- Do not scratch or damage the front grille.
- Do not replace the front grille, or bumper.
- Do not remove or disassemble the radar sensor.

Consult a dealer if:

- The radar sensor cover is strongly impacted.
- The front grille or bumper needs to be repaired.

If the vehicle is involved in any of the following situations, the radar sensor may not work properly. Have your vehicle checked by a dealer:

- Your vehicle is involved in a frontal collision.
- Your vehicle drives through deep water or is submerged in deep water.
- Your vehicle strongly strikes a bump, curb, chock, slope, or embankment that could jar the radar sensor.

Sonar Sensors

■ Location and range of sensors

The sonar sensors are situated in the front and rear bumpers.

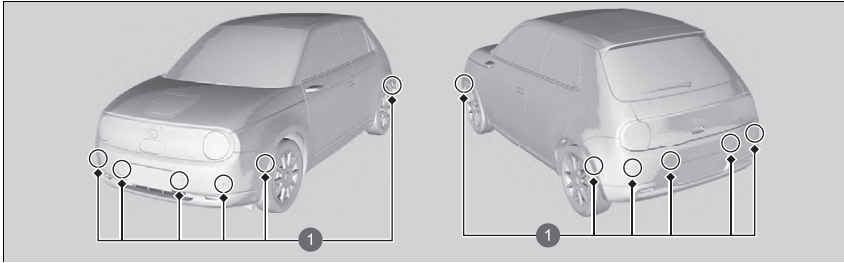

① Sonar Sensors

▣ Sonar Sensors

For the sonar sensors to work properly, do not:

- Place stickers or other objects on or around the sensors.
- Hit the area around the sensors.
- Attempt to take apart any sensor.
- Put any accessories on or around the sensors.

Consult with a dealer if:

- A sensor has been subjected to shock.
- Work needs to be done to the area around a sensor.

In the following cases, the sonar sensors may not work properly. Have your vehicle checked by a dealer.

- The front or rear bumper has made contact with a hill, parking block, curb, embankment, etc.
- The vehicle has been involved in frontal or rear collision.
- The vehicle has been driven through a deep puddle.

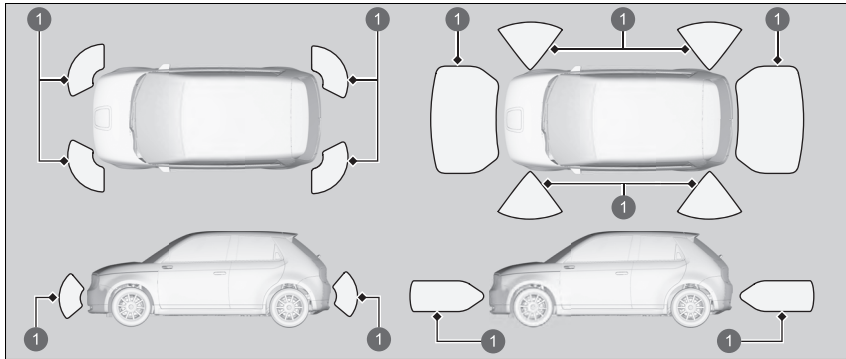

① Sensor Range

While Honda Parking Pilot is in operation, the sensors located on the sides of the front and rear bumpers can also operate.

Brake System

■ Parking Brake

Use the electric parking brake to keep the vehicle stationary when parked. When the parking brake is applied, you can manually or automatically release it.



1 Electric Parking Brake Switch



1 Electric Parking Brake Switch

■ To apply

The electric parking brake can be applied any time the vehicle has 12-volt battery, no matter which position the power mode is in.

Pull the electric parking brake switch up gently and securely.

- ▶ The indicator in the switch comes on.
- ▶ The parking brake and brake system indicator (red) comes on.

■ To release

The power mode must be in ON in order to release the electric parking brake.

1. Depress the brake pedal.
2. Press the electric parking brake switch.
 - ▶ The indicator in the switch goes off.
 - ▶ The parking brake and brake system indicator (red) goes off.

Manually releasing the parking brake using the switch helps your vehicle start slowly and smoothly when facing down hill on steep hills.

⌘ Brake System

When you depress the brake pedal, you may hear a whirring sound from the power system compartment. This is because the brake system is in operation, and it is normal.

⌘ Parking Brake

You may hear the electric parking brake system motor operating from the rear wheel area when you apply or release the electric parking brake. This is normal.

The brake pedal may slightly move due to the electric parking brake system operation when you apply or release the electric parking brake. This is normal.

You cannot apply or release the electric parking brake if the 12-volt battery goes dead.

➤ **If the 12-Volt Battery Is Dead** P. 647

If you pull up and hold the electric parking brake switch while driving, the brakes on all four wheels are applied by the electric servo brake system until the vehicle comes to a stop. The electric parking brake then applies, and the switch should be released.

■ Automatic parking brake feature operation

If the automatic parking brake feature has been activated:

- The parking brake is applied automatically when you set the power mode to VEHICLE OFF (LOCK).
- To confirm that the parking brake is applied, check if the parking brake and brake system indicator is on.
 - ▶ **Activating and deactivating the automatic parking brake feature** P. 499

■ To release automatically

Depressing the accelerator pedal releases the electric parking brake. Use the accelerator pedal to release the electric parking brake when you are starting the vehicle facing uphill, or in a traffic jam.

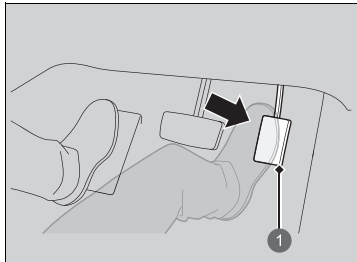

① Accelerator Pedal

The electric parking brake automatically releases as you depress the accelerator pedal when:

- You are wearing the driver's seat belt.
- The power system is on.
- The transmission is not in **P** or **N**.

Gently depress the accelerator pedal. When on a hill, it may require more accelerator input to release.

- ▶ The parking brake and brake system indicator goes off.

⊠ Parking Brake

In the following situations, the electric parking brake automatically operates.

- When the vehicle stops with the automatic brake hold system activated for more than 10 minutes.
- When the driver's seat belt is unfastened while your vehicle is stopped and brake hold is applied.
- When the power system is turned off, while brake hold is applied.
- When there is a problem with the brake hold system while brake hold is applied.
- When the vehicle stops more than 10 minutes while ACC with Low Speed Follow is activated.
- When the driver's seat belt is unfastened while your vehicle is stopped automatically by ACC with Low Speed Follow.
- When the power system is turned off, while ACC with Low Speed Follow is activated.

If the electric parking brake cannot be released automatically, release it manually.

When the vehicle is travelling uphill, the accelerator pedal may need to be pressed farther to automatically release the electric parking brake.

The electric parking brake cannot be released automatically while the following indicator is on:

- Transmission system indicator

■ Activating and deactivating the automatic parking brake feature

With the power mode set to ON, carry out the following steps to either activate or deactivate the automatic parking brake feature.

1. Change the shift position to **P**.
2. Without depressing the brake pedal, pull up the electric parking brake switch.
 - ▶ Check that the parking brake and brake system indicator has come on.
3. Pull up and hold the parking brake switch. When you hear a beeping sound, release the switch and within 3 seconds pull up and hold the switch again.
4. When you hear a sound indicating that the procedure is completed, release the switch.
 - ▶ Two beeps indicates that the feature has been activated.
 - ▶ One beep indicates that the feature has been deactivated.
 - ▶ When you have completed activating the feature, the parking brake will remain applied after you turn off the power system.
 - ▶ To confirm that the parking brake is applied, check if the parking brake and brake system indicator is on.

If you need to temporarily deactivate the feature for when having your vehicle towed. You can follow the procedure explained below.

1. Depress the brake pedal and bring the vehicle to a stop.
2. Set the power mode to VEHICLE OFF (LOCK) and then within 2 seconds push down the electric parking brake switch.
 - ▶ Activation and deactivation settings for the feature will not be affected.
 - ▶ Before temporarily deactivating the feature, make sure to first turn off the automatic brake hold system.
 - ▶ To confirm that the parking brake is applied, check if the parking brake and brake system indicator is on.

⌘ Parking Brake

The electric parking brake may not be released automatically while the following indicators are on:

- Parking brake and brake system indicator (amber)
- VSA system indicator
- **ABS** indicator
- Supplemental restraint system indicator

⌘ Activating and deactivating the automatic parking brake feature

In cold climates, the parking brake may freeze in place if applied.

When parking the vehicle, chock the wheels and make sure the automatic parking brake feature is deactivated.

Also, when putting your vehicle through a conveyortype car wash or when having your vehicle towed, deactivate the automatic parking brake feature and leave the parking brake released.

■ Foot Brake

Your vehicle is equipped with disc brakes at all four wheels. The brake assist system increases the stopping force when you depress the brake pedal hard in an emergency situation. The anti-lock brake system (ABS) helps you retain steering control when braking very hard.

➤ **Brake Assist System** P. 505

➤ **Anti-lock Brake System (ABS)** P. 504

☒ Foot Brake

Check the brakes after driving through deep water, or if there is a buildup of road surface water. If necessary, dry the brakes by lightly depressing the pedal several times.

If you hear a continuous metallic friction sound when applying the brakes, the brake pads need to be replaced. Have your vehicle checked by a dealer.

Applying constant pressure to the brakes while going down a long hill can cause the brakes to heat up, resulting in a loss of stopping power. Therefore, when descending a long hill, release the accelerator pedal and allow regenerative braking to slow the vehicle down. To adjust the rate of deceleration, use the deceleration paddle selector.

When the high voltage battery has fully recharged regenerative braking may not be possible.

➤ **POWER/CHARGE Gauge** P. 154

➤ **High Voltage Battery Charge Level Gauge**
P. 154

➤ **Deceleration Paddle Selector** P. 393

Do not rest your foot on the brake pedal while driving, as it will lightly apply the brakes and cause them to lose effectiveness over time and reduce pad life. It will also confuse drivers behind you.

■ Automatic Brake Hold

Keeps the brake applied after releasing the brake pedal until the accelerator pedal is pressed. You can use this system while the vehicle is temporarily stopped, like at traffic lights and in heavy traffic.

■ Turning on the system

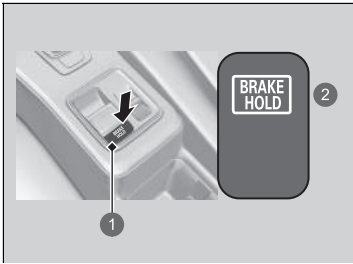

- ① Automatic Brake Hold Button
- ② Comes On

Fasten your seat belt properly, then start the power system. Press the automatic brake hold button.

- The automatic brake hold system indicator comes on. The system is turned on.

ⓘ Automatic Brake Hold

⚠ WARNING

Activating the automatic brake hold system on steep hills or slippery roads may still allow the vehicle to move if you remove your foot from the brake pedal.

If a vehicle unexpectedly moves, it may cause a crash resulting in serious injury or death.

Never activate the automatic brake hold system or rely on it to keep a vehicle from moving when stopped on a steep hill or slippery roads.

⚠ WARNING

Using the automatic brake hold system to park the vehicle may result in the vehicle unexpectedly moving.

If a vehicle moves unexpectedly, it may cause a crash, resulting in serious injury or death.

Never leave the vehicle when braking is temporarily kept by automatic brake hold and always park the vehicle by putting the transmission in **P** and applying the parking brake.

■ Activating the system

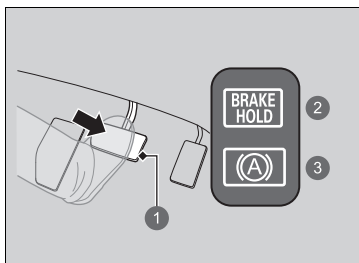

- ① Brake Pedal
- ② On
- ③ Comes On

■ Cancelling the system

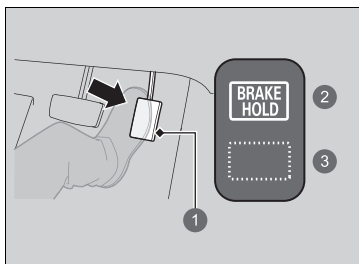

- ① Accelerator Pedal
- ② On
- ③ Goes Off

Depress the brake pedal to come to a complete stop. The transmission must not be in **P** or **R**.

- The automatic brake hold indicator comes on. Braking is kept for up to 10 minutes.
- Release the brake pedal after the automatic brake hold indicator comes on.

⌘ Automatic Brake Hold

While the system is activated, you can turn off the power system or park the vehicle through the same procedure as you normally do.

➤ **When Stopped** P. 507

Whether the system is on, or the system is activated, the automatic brake hold turns off once the power system is off.

■ **The system automatically cancels when:**

- You engage the electric parking brake.
- You depress the brake pedal and put the transmission into **P** or **R**.

■ **The system automatically cancels and the parking brake is applied when:**

- Braking is kept for more than 10 minutes.
- The driver's seat belt is unfastened.
- The power system is turned off.
- There is a problem with automatic brake hold system.

■ **Turning off the automatic brake hold system**

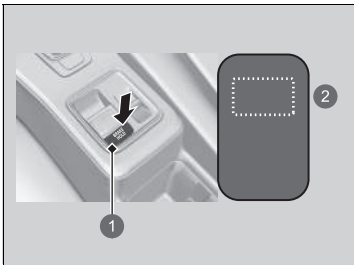

- ① Automatic Brake Hold Button
- ② Goes Off

While the system is on, press the automatic brake hold button again.

- ▶ The automatic brake hold system indicator goes off.

If you want to turn off automatic brake hold while the system is in operation, press the automatic brake hold button with the brake pedal depressed.

☒ **Turning off the automatic brake hold system**

Make sure to turn off the automatic brake hold system before using an automated car wash.

You may hear an operating noise if the vehicle moves while the automatic brake hold system is in operation.

Anti-lock Brake System (ABS)

■ ABS

Helps to prevent the wheels from locking up, and helps you to retain steering control by pumping the brakes rapidly, much faster than you.

The electronic brake distribution (EBD) system, which is part of the ABS, also balances the front-to-rear braking distribution according to vehicle loading.

You should never pump the brake pedal. Let the ABS work for you by always keeping firm, steady pressure on the brake pedal. This is sometimes referred to as “stomp and steer.”

■ ABS operation

The brake pedal may pulsate slightly when the ABS is working. Depress the brake pedal and keep holding the pedal firmly down. On dry pavement, you will need to press on the brake pedal very hard before the ABS activates. However, you may feel the ABS activate immediately if you are trying to stop on snow or ice.

ABS may activate when you depress the brake pedal when driving on:

- Wet or snow covered roads.
- Roads paved with stone.
- Roads with uneven surfaces, such as potholes, cracks, manholes, etc.

When the vehicle speed goes under 10 km/h (6 mph), the ABS stops.

ⓘ Anti-lock Brake System (ABS)

NOTICE

The ABS may not function correctly if you use a tyre of the wrong size or type.

If the **ABS** indicator comes on while driving, there may be a problem with the system. While normal braking will not be affected, there is a possibility that the ABS will not be operating. Have your vehicle checked by a dealer immediately.

The ABS is not designed for the purpose of reducing the time or distance it takes for a vehicle to stop: It is designed to limit brake lockup which can lead to skidding and loss of steering control.

In the following cases, your vehicle may need more distance to stop than a vehicle without the ABS:

- You are driving on rough or uneven road surfaces, such as gravel or snow.
- The tyres are equipped with tyre chains.

The following may be observed with the ABS system:

- Motor sounds coming from the motor compartment when the brakes are applied, or when system checks are being performed after the power system has been turned on and while the vehicle is accelerates.

- Brake pedal and/or the vehicle body vibration when ABS activates.

These vibrations and sounds are normal to ABS systems and are no cause for concern.

Brake Assist System

Is designed to assist the driver by generating greater braking force when you depress the brake pedal hard during emergency braking.

■ Brake assist system operation

Press the brake pedal firmly for more powerful braking.

Emergency Stop Signal

Activates when you brake hard while driving at 60 km/h (37 mph) or above to alert drivers behind you about sudden braking by rapidly flashing hazard warning lights. This may help to alert drivers behind you to take appropriate means to avoid a possible collision with your vehicle.

■ When the system activates:

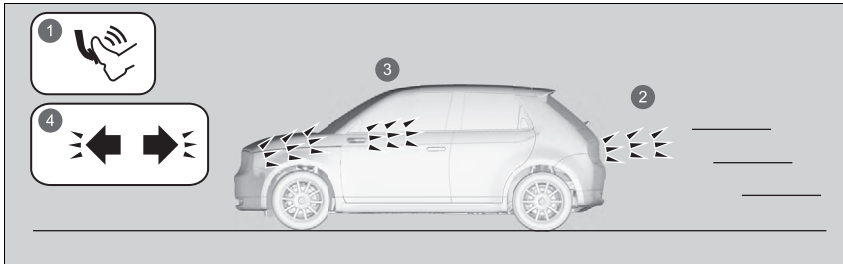

- ① Hard Braking
- ② Brake Lights Come On
- ③ Hazard Warning Lights Flash
- ④ Hazard Warning Indicators Blink

The hazard warning lights stop flashing when:

- You release the brake pedal.
- The ABS is deactivated.
- Your vehicle's decelerating speed becomes moderate.
- You press the hazard warning button.

ⓘ Emergency Stop Signal

The emergency stop signal is not a system that can prevent a possible rear-end collision caused by your hard braking. It flashes the hazard warning lights at the time you are braking hard. It is always recommended to avoid hard braking unless it is absolutely necessary.

The emergency stop signal does not activate with the hazard warning button pressed in.

If the ABS stops working for a certain period during braking, the emergency stop signal may not activate at all.

When Stopped

1. Depress the brake pedal firmly.
2. With the brake pedal depressed, pull up the electric parking brake switch slowly, but fully.
3. Put the transmission into **P**.
 - ▶ Do not release the brake pedal until you have confirmed that **P** is shown on the shift position indicator.
4. Turn off the power system.
 - ▶ The parking brake and brake system indicator goes off in about 30 seconds.

Always set the electric parking brake firmly, in particular if you are parked on an incline.

» Parking Your Vehicle

⚠ WARNING

The vehicle can roll away if left unattended without confirming that Park is engaged. A vehicle that rolls away could cause a crash resulting in serious injury or death. Always keep your foot on the brake pedal until you have confirmed that **P** is shown on the shift position indicator.

» When Stopped

NOTICE

The following can damage the driveline:

- Depressing the accelerator and brake pedals simultaneously.
- Changing to **P** before the vehicle stops completely.

When facing uphill, do not hold the vehicle by depressing the accelerator pedal. Doing so may cause the power system to overheat and fail.

⌘ When Stopped

In extremely cold temperatures, the electric parking brake may freeze up if applied. If such temperatures are expected, do not apply the electric parking brake but, if parking on a slope, either turn the front wheels so they will contact the curb if the vehicle rolls down the slope or block the wheels to keep the vehicle from moving. If you do not take either precaution, the vehicle may roll unexpectedly, leading to a crash.

Parking Sensor System

The corner, side and centre sensors monitor obstacles around your vehicle, and the beeper, audio/information screen let you know the approximate distance between your vehicle and the obstacle.

■ The sensor location and range

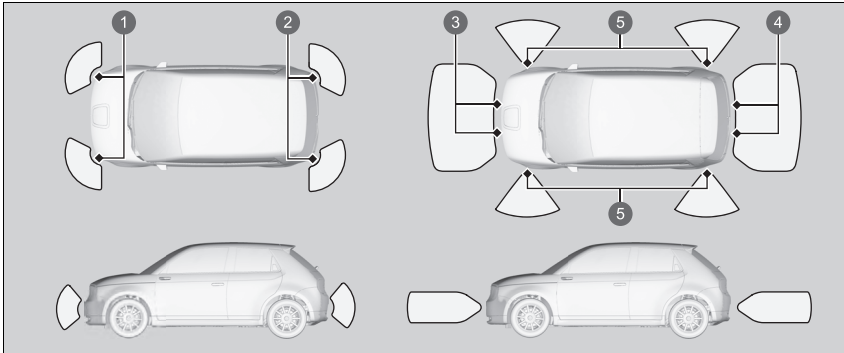

- ① Front Corner Sensors
- ② Rear Corner Sensors
- ③ Front Centre Sensors
- ④ Rear Centre Sensors
- ⑤ Side Sensors

▣ Parking Sensor System

Even when the system is on, always confirm if there is no obstacle near your vehicle before parking.

The system may not work properly when:

- The sensors are covered with snow, ice, mud, or dirt.
- The vehicle has been out in hot or cold weather.
- There is something nearby that emits ultrasonic waves or high frequency sounds.
- Driving in bad weather (rain, fog, snow, etc.).
- Any accessories have been put on or around the sensors.

The system may not detect these obstacles:

- Thin or low objects.
- Sonic-absorptive materials, such as snow, cotton, or sponge.
- Objects directly under the bumper.

The system may falsely detect obstacles in the following situations:

- The vehicle is on uneven surface, such as grass, bumps, or a hill.
- When close to other vehicles with sonar sensors or other objects that emit ultrasonic waves.
- There is splashing water near the sensors due to heavy rains, etc.

Do not put any accessories on or around the sensors.

Continued

■ Parking sensor system on and off

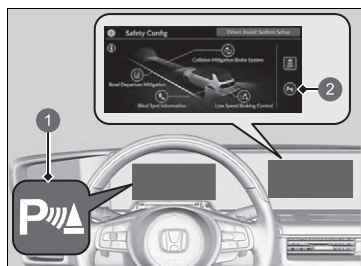

- 1 Parking Sensor Indicator (green)
- 2 Parking Sensor Icon

The  icon is in the safety config of the audio/information screen.

To disable parking sensor, press the  icon.

➤ **Driver Assist System On and Off** P. 322

The front corner, rear centre and rear corner sensors start to detect an obstacle when the transmission is in **[R]**, and the vehicle speed is less than 8 km/h (5 mph).

The front corner and front centre sensors start to detect an obstacle when the transmission is in any position other than **[P]** or **[R]**, and the vehicle speed is less than 8 km/h (5 mph).

When Honda Parking Pilot is in operation, the Parking Sensor System will turn on, and all parking sensors will start to monitor obstacles while the vehicle speed is less than 8 km/h (5 mph).

▶▶ Parking Sensor System

When the vehicle is moving forward at 8 km/h (5 mph) or less, the system detects any obstacles in front of the vehicle and the forward camera image will display as the distance between them decreases.



➤ **Multi-View Camera** P. 517

When the obstacle is no longer detected or it is located between a detection range and a non-detection range, the display will return to the previous screen.

You can customize whether or not to display the forward camera image when an obstacle is detected.

➤ **Customized Features** P. 323

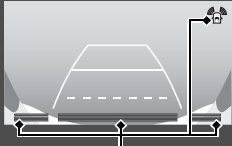
■ When the distance between your vehicle and obstacles becomes shorter

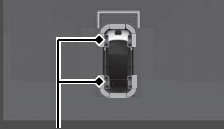
Length of the intermittent beep	Distance between the Bumper and Obstacle		Indicator	Audio/information screen
	Corner Sensors/ Side Sensors*2	Centre Sensors		
Moderate	—	Front: About 100-60 cm (39-23 inches) Rear: About 110-60 cm (43-23 inches)	Blinks in Yellow*1	 <p>Indicators light where the sensor detects an obstacle</p>  <p>Indicators light where the sensor detects an obstacle.</p>  <p>Indicators light where the sensor detects an obstacle*2.</p>
Short	About 60-45 cm (23-17 inches)	About 60-45 cm (23-17 inches)	Blinks in Amber	
Very short*3	About 45-35 cm (17-13 inches)	About 45-35 cm (17-13 inches)	Blinks in Amber*3	
Continuous*3	About 35 cm (13 inches) or less	About 35 cm (13 inches) or less	Blinks in Red*3	

*1: At this stage, only the centre sensors detect obstacles.

*2: While Honda Parking Pilot is in operation, the sensors located on the sides of the front and rear bumpers can also operate.

*3: While Honda Parking Pilot is in operation, the intermittent beep sounds continuously or very short, and the indicator blinks in red or amber.

■ Screen Operation

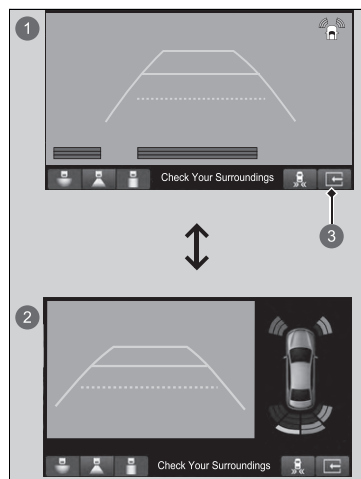

You can switch the display to normal display or split display by touching the  icon.

- ① Normal Display
- ② Split Display
- ③  Icon

Cross Traffic Monitor

Monitors the rear corner areas using the radar sensors when reversing, and alerts you if a vehicle approaching from a rear corner is detected.

The system is convenient especially when you are getting out of a parking space backwards.

How the System Works

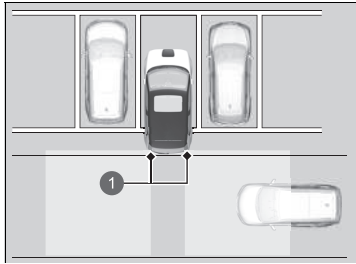

① Radar sensors: Underneath the rear bumper corners

When a vehicle is detected approaching from a rear corner, Cross Traffic Monitor alerts you with a buzzer and a displayed warning.

The system will not detect a vehicle that approaches from directly behind your vehicle, nor will it provide alerts about a detected vehicle when it moves directly behind your vehicle.

The system does not provide alerts for a vehicle that is moving away from your vehicle, and it may alert for pedestrians, bicycles, or stationary objects.

The system activates when:

- The power mode is in ON.
- The Cross Traffic Monitor is turned on.
 - ▶ **Cross Traffic Monitor On and Off** P. 516
- The transmission is in **R**.
- Your vehicle is moving at 5 km/h (3 mph) or lower.

⚠ Cross Traffic Monitor

CAUTION

Cross Traffic Monitor cannot detect all approaching vehicles and may not detect an approaching vehicle at all.

Failure to visually confirm that it is safe to back up the vehicle before doing so may result in a collision.

Do not solely rely on the system when reversing; always also use your mirrors, and look behind and to the sides of your vehicle before reversing.

Cross traffic monitor may not detect or may delay detecting an approaching vehicle, or may alert detection without an approaching vehicle under the following conditions:

- An obstacle, such as another vehicle and a wall, near your vehicle's rear bumper, is blocking the radar sensor's scope.
- Your vehicle is moving at the speed of about 5 km/h (3 mph) or higher.
- A vehicle is approaching at the speed other than between about 10 km/h and 25 km/h (6 mph and 16 mph).
- The system picks up external interference such as other radar sensors from another vehicle or strong radio wave transmitted from a facility nearby.

Continued

⌘ Cross Traffic Monitor

- Either corner of the rear bumper is covered with snow, ice, mud or dirt.
- When there is bad weather.
- Your vehicle is on an incline.
- Your vehicle is tilted due to a heavy load in the rear.
- Your vehicle is reversing towards a wall, a pole, a vehicle, and so on.

The rear bumper or the sensors have been improperly repaired or the rear bumper has been deformed. Have your vehicle checked by a dealer.

For proper operation, always keep the rear bumper corner area clean. Do not cover the rear bumper corner area with labels or stickers of any kind.

The parking sensor system's alerting buzzer overrides the Cross Traffic Monitor buzzer when the sensors are detecting obstacles at the closest range.



■ When the System Detects a Vehicle



- ① Arrow Icon
- ② Normal View
- ③ Wide View

An arrow icon appears on the side a vehicle is approaching on the audio/information screen.

⊞ When the System Detects a Vehicle

If the  on the lower right changes to  in amber when the transmission is in **[R]**, mud, snow, ice and other debris may have accumulated in the vicinity of the sensor. The system is temporarily cancelled. Check the bumper corners for any obstructions, and thoroughly clean the area if necessary.

If the  comes on when the transmission is in **[R]**, there may be a problem with the Cross Traffic Monitor system. Do not use the system and have your vehicle checked by a dealer.

If the display remains the same with the transmission in **[R]**, there may be a problem with the rear camera system and the Cross Traffic Monitor system. Do not use the system and have your vehicle checked by a dealer.

Continued

■ Cross Traffic Monitor On and Off

Tap to turn the system on and off. The indicator comes on with the system on. You can also switch the system on and off from the customized feature on the audio/information screen.

➤ **Customized Features** P. 323

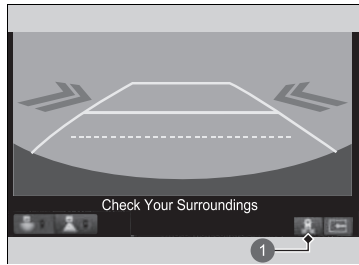

1 Icon

Multi-View Camera

Is a four camera system that views areas commonly known as “blind spots” from different angles, then displays the images on the audio/information screen. This system can be used to:

- Check for obstacles when you are moving in **R**.
 - **Checking for Obstacles at the Back of Your Vehicle** P. 524
- Check the right and left sides of the vehicle while crossing at intersections with poor visibility (obstructed view, etc.).
 - **Checking from the front blind view at intersections** P. 528
- Check for obstacles in front of the vehicle when parking or maneuvering in confined areas.

Multi-View Camera

WARNING

Failure to visually assess the area around the vehicle (directly or by use of the mirrors) may result in a crash causing serious injury or death.

The areas shown in the multi-view camera system display are limited. The display may not show all pedestrians or other objects around your vehicle.

Do not solely rely only on the multi-view camera system display to assess whether it is safe to move your vehicle.

WARNING

Failure to pay proper attention to your surroundings while driving may result in a crash causing serious injury or death.

To help mitigate the chances of a collision, only look at the multi-view camera system display when it is safe to do so.

The multi-view camera system does not eliminate all blind spots. The system is for your convenience only.

Continued

■ Displaying an Image From the Multi-View Cameras



1 **CAMERA** button

■ For frontal views:

Press the **CAMERA** button when the vehicle is stationary or moving at 20 km/h (12 mph) or slower. Press the button again to switch camera views.

■ For rear reviews:

Change the shift position to **R** when the vehicle is stationary. Press the **CAMERA** button again to switch rear view mode. You can customize the display setting.

➤ **Customized Features** P. 323

▶ Multi-View Camera

Always keep the camera lenses clean and free from debris.

When the parking sensor system detects any obstacles, the indicator will display.

➤ **Parking Sensor System** P. 509

When a vehicle is detected approaching from a rear corner, Cross Traffic Monitor alerts you.

➤ **Cross Traffic Monitor** P. 513

■ Camera Locations and Images

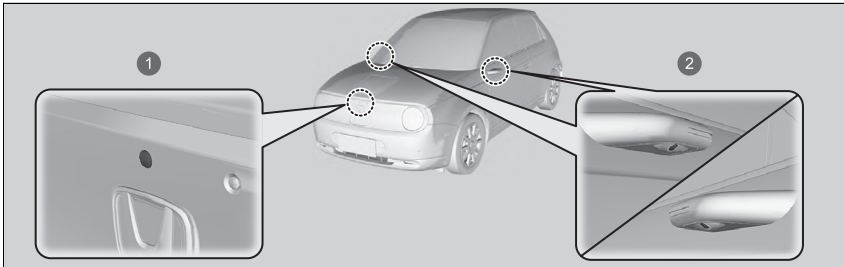

- ❶ Front view Camera
- ❷ Side view Cameras

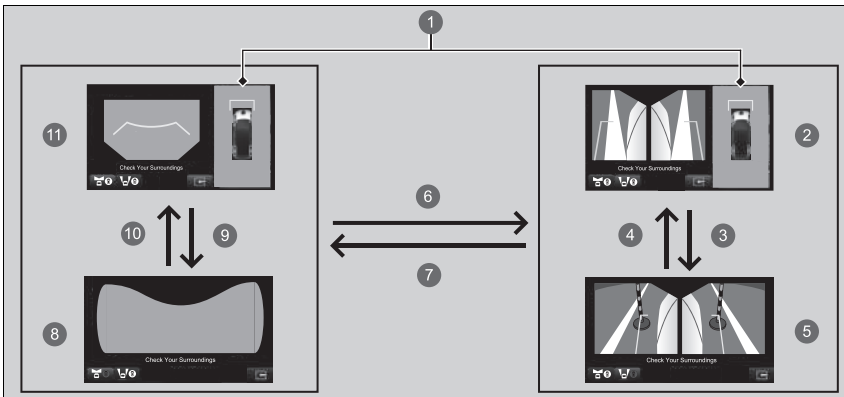

☒ Camera Locations and Images



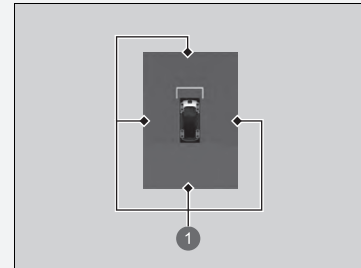









While Honda Parking Pilot is in operation, indicators light where the camera detects an obstacle on the Honda Parking Pilot Display.



- ❶ indicators light where the camera detects an obstacle

☒ **Honda Parking Pilot**
P. 531

Continued

- 1 Ground View: An overhead view created by the combination of images captured by four cameras.
- 2 Left and Right Side View + Ground View
- 3  or 
- 4  or 
- 5 Left and Right Side View
- 6  or  or **CAMERA** button
- 7  or  or **CAMERA** button
- 8 Front Blind View
- 9  or 
- 10  or 
- 11 Front View + Ground View

The unique multi-view camera lenses make distances appear differently than they actually are - objects seen on the audio/information screen may appear closer or further away, and may be distorted. This becomes more apparent the further away an object is from your vehicle.

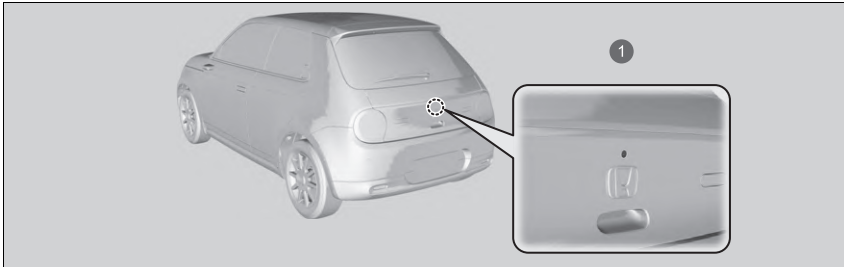

1 Rear view Camera

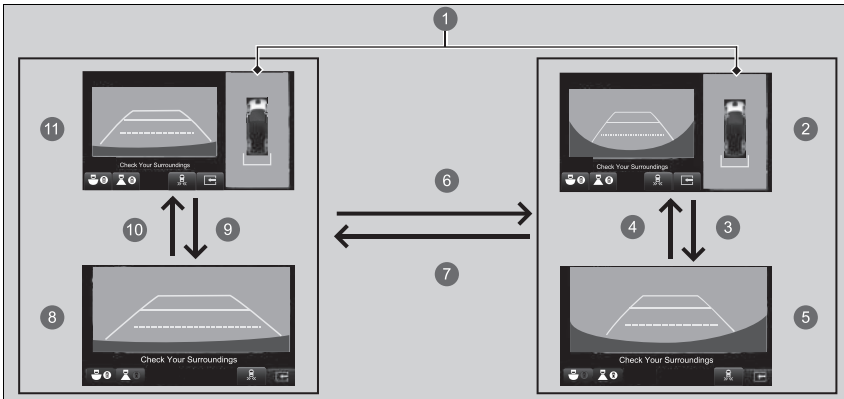











1 Ground View: An overhead view created by the combination of images captured by four cameras.

2 Rear Wide View + Ground View

3 or

Continued

- 4  or 
- 5 Rear Wide View
- 6  or  or **CAMERA** button
- 7  or  or **CAMERA** button
- 8 Rear Normal View
- 9  or 
- 10  or 
- 11 Rear Normal View + Ground View

The unique multi-view camera lenses make distances appear differently than they actually are - objects seen on the audio/information screen may appear closer or further away, and may be distorted. This becomes more apparent the further away an object is from your vehicle.

Reference Lines and Guide Lines

Following can be displayed when the multi-view camera system is on.

Fixed Guideline: Helps you to get a sense of a distance between your vehicle and the surroundings. The distance may appear differently than the actual distance.

Dynamic Guideline: Indicates vehicle direction while the steering wheel is in the current position.

▶▶ Displaying an Image From the Multi-View Cameras

The navigation system is disabled when the shift position is in **[R]**.

If you press the **CAMERA** button while the vehicle speed is more than 20 km/h (12 mph), the standby screen appears.

When the vehicle speed is reduced below 20 km/h (12 mph), the screen switches to a multi-view camera system image.

The positions/distances indicated by the guide lines and camera views on the display may differ from the actual positions/distances due to the changes in the vehicle height, road conditions, and other factors. The guide lines should be used as a reference only.

The guide lines can be turned on and off using the audio/information screen.

▶▶ **Customized Features** P. 323

If you turn the guide lines off, they remain off until you turn them back on.

■ Using the Multi-View Camera

■ Checking for Obstacles at the Back of Your Vehicle

The display automatically changes to the rear view when the shift position is changed to **R**.

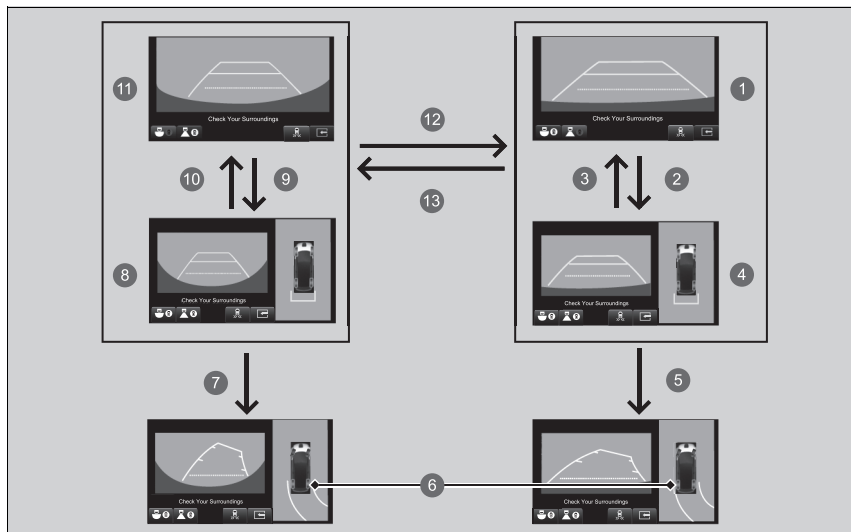





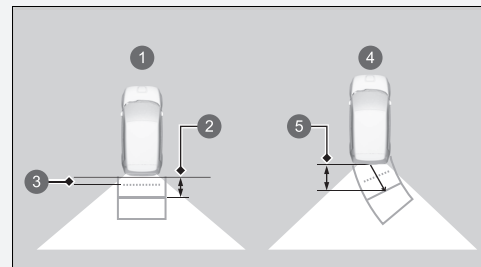







☒ Checking for Obstacles at the Back of Your Vehicle

When changing the shift position from/to **R**, you may experience a delay in switching between the audio/information screen and a rear view image.



Approximate distances:

- ① The guide lines indicate
- ② 1m (39.3 inches)
- ③ 50cm (20 inches)
- ④ The projection lines indicate
- ⑤ 1m (39 inches)

- 1 Rear Normal View
- 2  or 
- 3  or 
- 4 Rear Normal View + Ground View
- 5 When the steering wheel is turned more than 90 degrees.
- 6 The projection lines appear 25 cm (9.8 inches) outside the vehicle body.
- 7 When the steering wheel is turned more than 90 degrees.
- 8 Rear Wide View + Ground View
- 9  or 
- 10  or 
- 11 Rear Wide View
- 12  or  or **CAMERA** button
- 13  or  or **CAMERA** button

■ Checking for the Sides of Your Vehicle

You can display the front ground view screen using all the four cameras for the system. Pressing the **CAMERA** button when the vehicle speed is at below 20 km/h (12 mph) changes the image as follows.

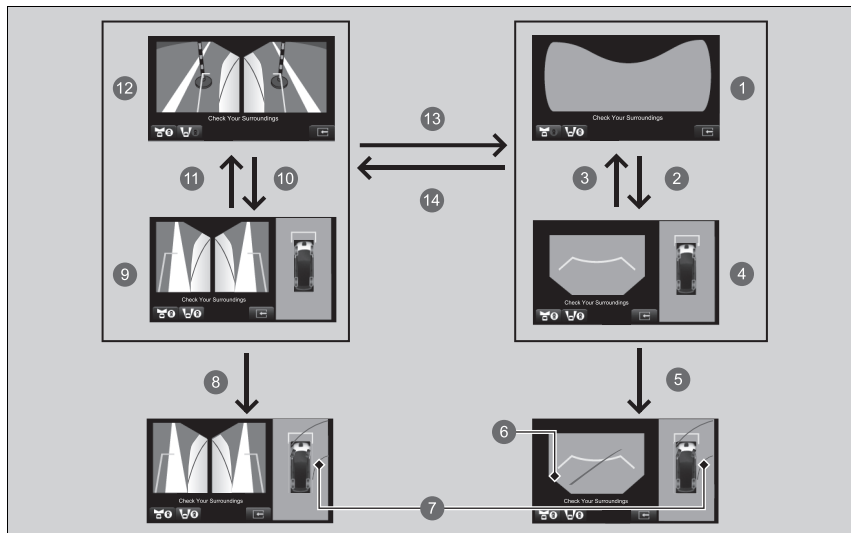





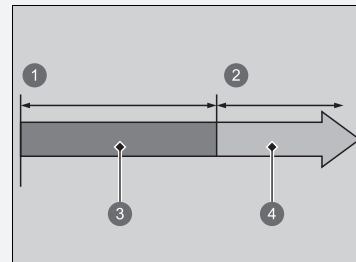







☒ Checking for the Sides of Your Vehicle

While the image from the multi-view cameras is being displayed if the vehicle speed exceeds 25 km/h (16 mph), the front or side view on the screen automatically switches to the audio/information screen.



- ① 0 km/h (0 mph)
- ② 25 km/h (16 mph)
- ③ Camera Screen
- ④ Audio/Information Screen

- ① Front Blind View
- ②  or 
- ③  or 
- ④ Front View + Ground View
- ⑤ When the steering wheel is turned more than 90 degrees.
- ⑥ Blind spots appear in black.
- ⑦ The projection lines appear 25 cm (9.8 inches) outside the vehicle body.
- ⑧ When the steering wheel is turned more than 90 degrees.
- ⑨ Left and Right Side View + Ground View
- ⑩  or 
- ⑪  or 
- ⑫ Left and Right Side View
- ⑬  or  or **CAMERA** button
- ⑭  or  or **CAMERA** button

▶▶ Checking for the Sides of Your Vehicle

Approximate distance the reference line indicates

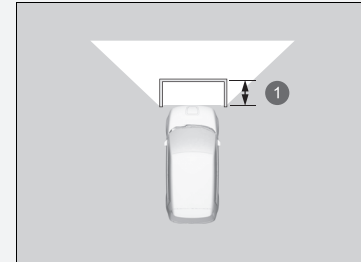

① 1 m (39.3 inches)

■ Checking from the front blind view at intersections

The front blind view screen is useful when you need to check for vehicles crossing from either direction at an intersection with poor visibility.

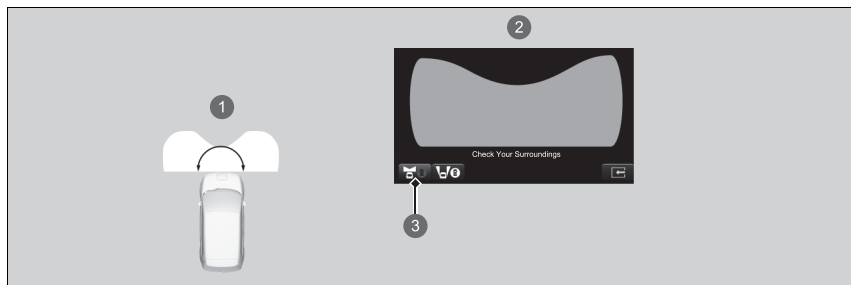

- 1 The angle provided by the front blind view screen is 180 degrees.
- 2 Front Blind View Screen
- 3 When pressing the **CAMERA** button and Front blind view icon.





☒ Checking from the front blind view at intersections

The front blind view is a wide-angled view. The image will be largely distorted, and objects may appear closer or more distant than they actually are.

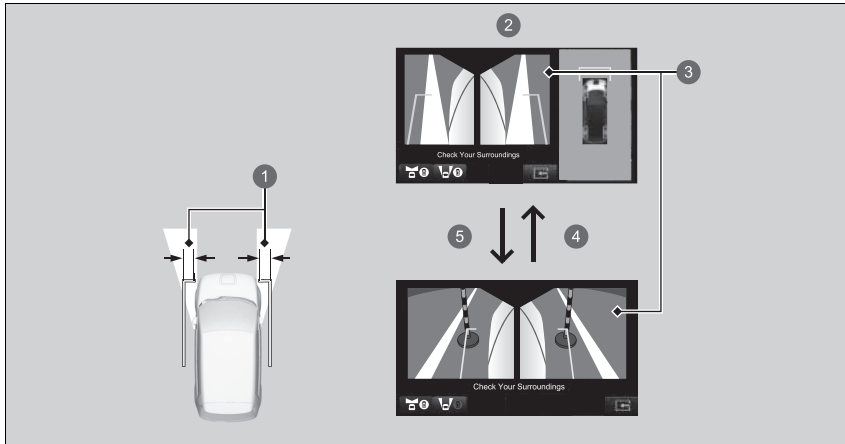
■ Checking the sides of your vehicle

The side view screens are convenient when you pull over at a curb or tollbooth, or slowly pass by oncoming vehicles on a narrow road.



- ① 30 cm (11.8 inches)
- ② Side View Screen
- ③ Side Views: The images from the side cameras
- ④  or 
- ⑤  or 

Approximate distance the projection lines indicate is 30 cm (11.8 inches) from the vehicle.

Multi-View Camera System Limitations

The system may not work properly under the following conditions.

Conditions		Solutions
The projection line is not accurate.		Have your vehicle checked by a dealer.
The images may not appear clearly when:	<ul style="list-style-type: none"> You activate the system in bad weather (heavy rain, snow, fog, etc.) or in the dark. Camera temperatures are high. A sudden change between light and dark such as an entrance or exit of a tunnel. You drive into the sunlight (e.g., at dawn or dusk.) A camera lens is scratched. 	Do not use the multi-view camera system but rely only on visual confirmation until the conditions allow the system to work properly.
	<ul style="list-style-type: none"> A camera lens is covered with dirt, moisture, or debris. When water drops or insects get on the camera lens. 	Clean camera lenses with a soft cloth moisturised with water, mild detergent or glass cleaner.
	<ul style="list-style-type: none"> The audio/information screen is dirty. 	Wipe off the screen using a soft dry cloth.
A camera angle is altered.	A camera or the area around the camera has been severely impacted.	Do not use the multi-view camera system and contact a dealer.
An error message is displayed while the multi-view camera system is in use.		
The image does not come on the screen when you press the CAMERA button on the audio/information screen and the vehicle is moving at 20 km/h (12 mph) or slower.		

■ Honda Parking Pilot

Assists with parking and exit.

Cameras and sonar sensors will detect any parking spaces and set a route for parking in or pulling out of a space. The system will then help you park in or exit the space by adjusting your speed, moving the steering wheel, and changing the shift position.

▣ Honda Parking Pilot

WARNING

Honda Parking Pilot is not an automatic parking system.

Like all assistance systems, Honda Parking Pilot has limitations.

Over reliance on this system may result in a collision.

If you encounter the following situations while using the system, stop the car or cancel system operation, then manually avoid the situation.

- When you are about to collide with an obstacle, pedestrian, or another vehicle.
- When you encounter curbs, bumps, or wheel stoppers that should not be driven over.
- When you are about to enter a “No Entry” area.

Just like when parking manually, always visually and directly check your surroundings.

The system can be used in the following situations:

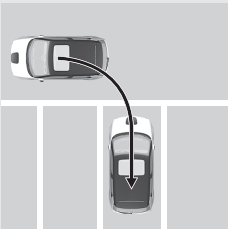
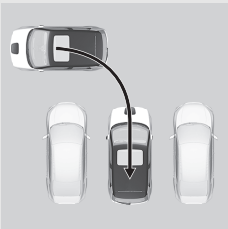
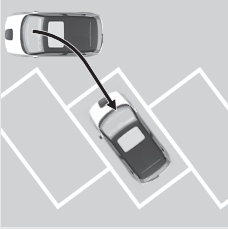
Parking patterns	Parking spaces with boundary lines	Parking spaces without boundary lines
Reverse parking		
Reverse angle parking*1		—

*1: The parking space can be detected if there are three or more boundary lines and enough spaces to park two or more vehicles.

⚠ WARNING

Do not use this system in unsuitable locations

Do not use Honda Parking Pilot on slopes, irregularly shaped parking spaces, and other locations where it is not suited for use.



➤ **Unsuitable Locations for System Use**
P. 534

For the front/side/rear cameras, refer to the following page.

➤ **Camera Locations and Images** P. 519

For directions on the proper handling of the sonar sensors, refer to the following page.

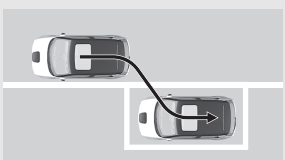
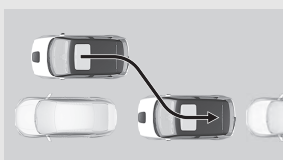
➤ **Sonar Sensors** P. 495

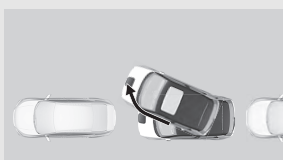
Parking patterns	Parking spaces with boundary lines	Parking spaces without boundary lines
Parallel parking		
Pulling out of parallel parking*1		

*1: Limited to where there is a vehicles in front.

■ Unsuitable Locations for System Use

Honda Parking Pilot is not suitable for use in locations where the vehicle may become unable to move forward or backwards or slip easily or the parking space like the following.

- There is a slope.
- The area is hilly or uneven.
- The area is unpaved and made of sand, gravel, grass, etc.
- The area is snow-covered.
- The area is slippery due to snow, ice, etc.
- The lane is narrow.
- There is an obstacle in front of the vehicle.
- The parking space is curved.
- Nearby vehicles are parked outside of the lines.

Reverse parking

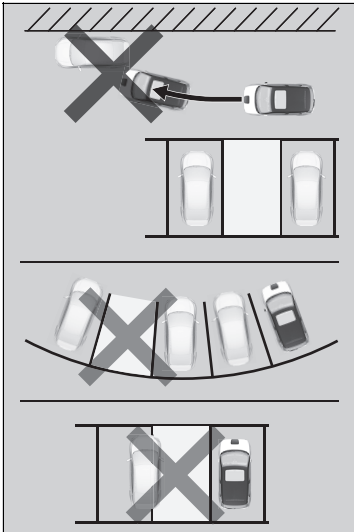

Parallel parking

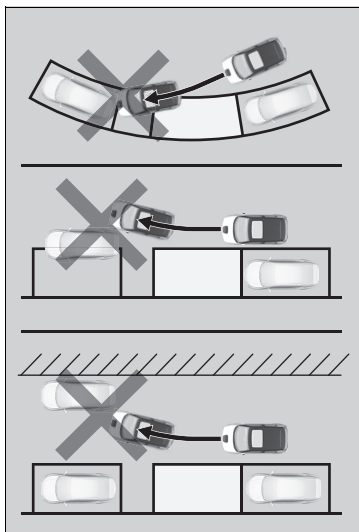

■ How to use Honda Parking Pilot

■ How to enter a parking space

You can use Honda Parking Pilot with parking spaces with boundary lines or similar guidelines, such as in the illustrations below.

You may not park properly if the parking spaces are too narrow or wide against the guidelines.

Reverse parking*1

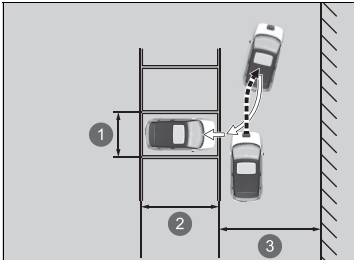

- ① About 2.5 m (8.2 ft.)
- ② Vehicle length + about 0.5 m (1.6 ft.) or more
- ③ Lane width 5.5 m (18.0 ft.) or more

*1: If there are no boundary lines, the distance between the two other vehicles is about 3.2 m (10.5 ft.).

▶▶ How to use Honda Parking Pilot

⚠ WARNING

Be careful not to get your hands caught in the steering wheel.

The steering wheel will turn automatically.
Be careful not to get your hands caught in the steering wheel.

Audio volume cannot be adjusted while Honda Parking Pilot is in use.

Reverse angle parking

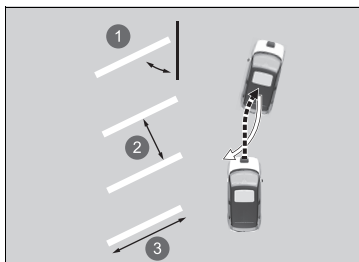

- ❶ About 60 degrees or 45 degrees
- ❷ About 2.5 m (8.2 ft.)
- ❸ Vehicle length + about 0.5 m (1.6 ft.) or more

Parallel Parking*1

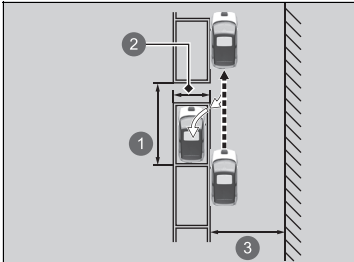

- ❶ About 5.5 m (18.0 ft.) or more
- ❷ White lines about 2.5 m (8.2 ft.)
- ❸ About 4.5 m (14.8 ft.) or more

*1: If there are no boundary lines, the distance between the other vehicles should be vehicle length + 1.5 m (4.9 ft.) or more

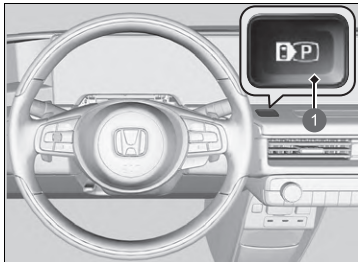

1 Honda Parking Pilot Switch

1. Press the Honda Parking Pilot switch and the Honda Parking Pilot mode will be displayed.

- ▶  (gray) will be displayed in the upper left of the screen.
- ▶ If the system is in pull out mode, you can choose parking mode by touching the **IN/OUT** icon.

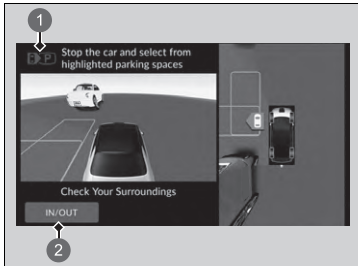

- 1  (gray)
- 2 **IN/OUT** Icon

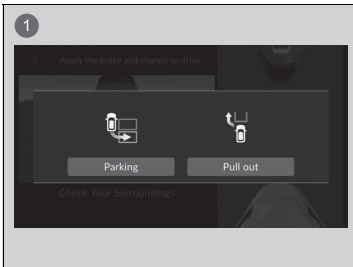

1 Mode Change Display

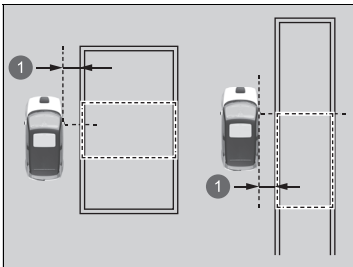

1 About 1 m (3.3 ft.)

2. Move the vehicle close to the space where you want to park, and slowly advance to within 1 m (3.3 ft.) of the parking space until you are parallel to the parking space. Stop when the candidate parking space is outlined in green on the display.

- ▶ The system will beep when it detects a parking space.
- ▶ The detected parking space boundary (green) may be adjusted depending on the vehicle position or other condition.

How to enter a parking space

Honda Parking Pilot cannot be used if the detected parking space is not shown.

Tips for detecting the target position

The parking space with boundary:

Stop so that the driver's seat is just beside the parking space.

The parking space without boundary:

Stop so that the driver's seat is behind the parking space.

When you select the parking space directly confirm the space of the area.

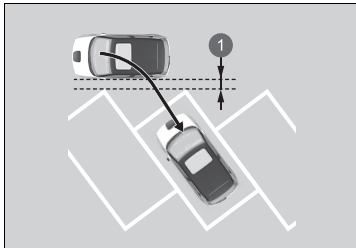

1 About 1 m (3.3 ft.)

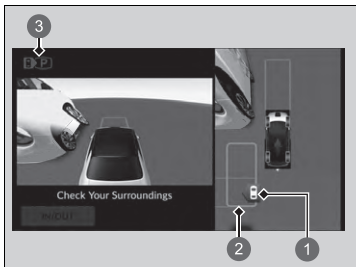

- 1 Parking Space (green)
- 2 Target Position (blue)
- 3  (gray)

- 3. While the vehicle is stopped, select the lines of any parking space (green) by touching the screen.
 - ▶ When the selection screen for reverse parking or parallel parking displays, select the applicable mode.
 - ▶ The selected lines of any parking space (green) will be the target position (blue).

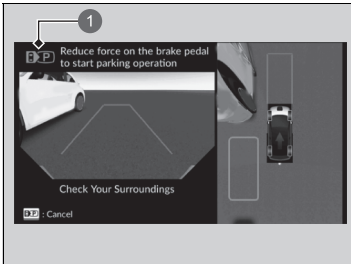
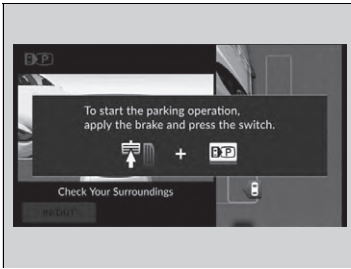



1  (blue)

4. Press the Honda Parking Pilot switch while depressing the brake pedal.

- ▶ When in operation, the system will beep and  will blink in blue in the upper left of the display.
- ▶ The shift position will change depending on the direction in which the vehicle is moving.

5. Check your surroundings, the route on the screen, and stopping position, then release the brake pedal.

- ▶ The vehicle will start to move. Adjust your speed with the brake pedal if necessary.
- ▶ When you have finished parking, the shift position will change to  and the parking brake will automatically engage.
- ▶ **Parking operation is complete** message will display, then it will return to the previous screen.
- ▶ Adjust the parking location or position if needed.
- ▶ After parking, confirm the shift position is in .

▶▶ How to enter a parking space

After the system begins to operate, if there is an obstacle in your path, stop the vehicle with the brake pedal, press the Honda Parking Pilot switch and stop operation.

After the vehicle moved close to the target position, it may be possible that the vehicle move again to adjust the vehicle position. Pay attention to the surroundings and stop the vehicle if needed.

You can stop the parking brake from automatically engaging after parking has finished.

▶ **Customized Features** P. 323

■ When pulling out from a parallel parking space

Honda Parking Pilot can be used if there is a vehicle in front of you at the following parking space.

Pull out

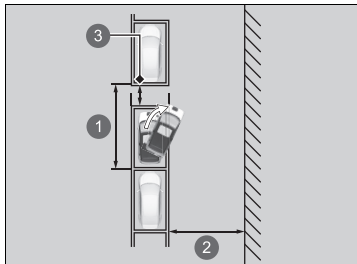

- ① About 5.5 m (18.0 ft.) or more
- ② About 4.5 m (14.8 ft.) or more
- ③ Distance of about 50 cm (20 inches) or more from other vehicles

▶▶ When pulling out from a parallel parking space

⚠ WARNING

Be careful not to get your hands caught in the steering wheel.

The steering wheel will turn automatically.
Be careful not to get your hands caught in the steering wheel.

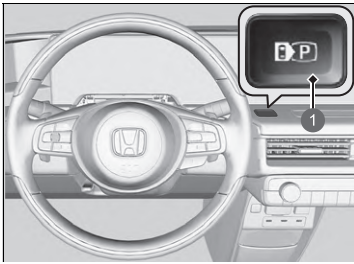

1 Honda Parking Pilot Switch

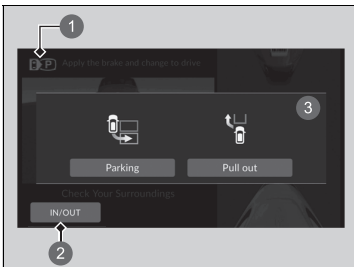

- 1 (gray)
- 2 **IN/OUT** Icon
- 3 Mode Change Display

1. Press the Honda Parking Pilot switch and the Honda Parking Pilot mode will be displayed.

- ▶ (gray) will be displayed in the upper left of the screen.
- ▶ If the system is in parking mode, you can choose pull out mode by touching the mode selector icon.
- ▶ Depress the brake pedal following the directions on the screen and change the shift position to **R**.

▶▶ When pulling out from a parallel parking space

The pull out function cannot be used if someone has double parked in front of the vehicle.

The pull out function cannot be used if the space between your vehicle and the vehicles in front of or behind you is extremely small or if there is a person or obstacle in between them.

Even if the parking sensor detects a person or obstacle while the pull out function is in use, it will continue to operate.

If a moving vehicle approaches from the rear, depress the brake pedal and stop the vehicle.

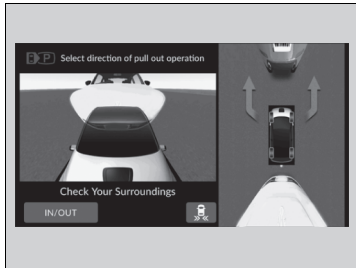

2. Tap and select the direction in which you will pull out on the screen with depressing the brake pedal.
3. Press the Honda Parking Pilot switch while depressing the brake pedal.
 - ▶ When in operation, the system will beep and  will blink in blue in the upper left of the display.
 - ▶ The shift position will change depending on the direction in which the vehicle is moving.
4. With the brake pedal depressed, release the parking brake by pressing the parking brake switch then release the brake pedal.
 - ▶ The vehicle will begin to move. Check your surroundings and adjust your speed using the brake pedal.
 - ▶ Pay attention to the situation in the direction in which you will pull out.
 - ▶ Once you have arrived at the point where pull out assistance will end, **Apply the brake to complete pull out operation** will display on the screen.

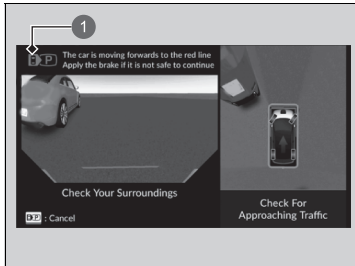

1  (blue)

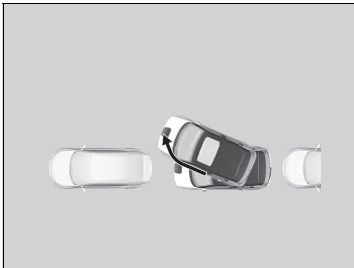

5. Follow the instructions and depress the brake pedal.
 - ▶ **Pull out operation is complete** will display in the upper left of the screen and assistance will end.
 - ▶ If the brake pedal is released, the vehicle will creep forward.
Make sure the shift position and manually control the vehicle.

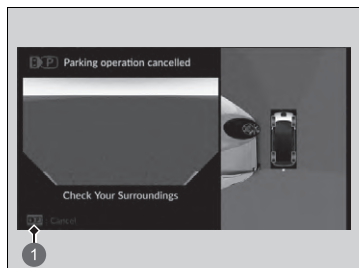

1 Cancel Icon

■ Honda Parking Pilot shut off

In order to turn off Honda Parking Pilot after parking assistance has begun, depress the brake pedal to stop the vehicle, then press the Honda Parking Pilot switch.

Even if you touch the cancel icon, Honda Parking Pilot will not turn off.

When operation is cancelled, a warning will sound and a message saying **Parking operation cancelled/Pull out operation cancelled** will be shown on the screen.

Depress the brake pedal.

- ▶ The system will return to the previous screen. Since the vehicle is no longer being controlled by the system, it will begin to creep if the brake pedal is released. Make sure the shift position and manually control the vehicle.

If Honda Parking Pilot is shut off, it is not possible to resume operation. You must start again from the beginning or park the vehicle manually.

■ Examples of shut off conditions

- The driver changed the shift position to **P**.
- The parking brake was engaged.
- About five minutes has passed since operation began.
- Vehicle Stability Assist (VSA) was activated.
- VSA was set to OFF.
- Something unusual was detected.
- Low Speed Braking Control was activated.
- The Collision Mitigation Braking System (CMBS) was activated.
- The vehicle speed is too high.
- The system cannot operate due to a slope.
- The vehicle cannot get over uneven ground.
- There is an obstacle in the parking space and the system has determined there is not enough space after starting.
- When switched more than a certain amount of times.
- When you deviate from the route or a route cannot be generated.

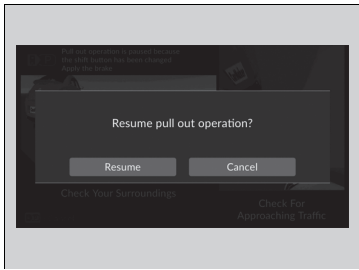
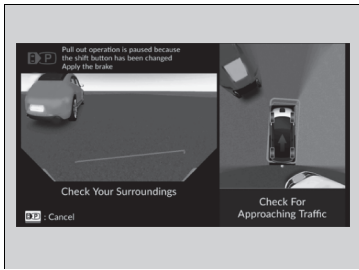

■ Pausing and restarting Honda Parking Pilot

If the system is paused, a beeper will sound, and a message will appear in the upper left of the screen.

Stop the vehicle by depressing the brake.

When assistance is able to be resumed,

Resume parking operation?/Resume pull out operation? will be displayed on the screen. While the brake pedal is depressed, touch the **Resume** icon on the screen and assistance will continue. Release the brake pedal.

- ▶ The vehicle will begin to move. Check your surroundings and adjust your speed using the brake pedal.
- ▶ If you touch the cancel button while the brake pedal is depressed, assistance will end and **Parking operation cancelled/ Pull out operation cancelled.** will be displayed.

Make sure the shift position and manually control the vehicle.

- ▶ If it is not possible to resume, **Resume** cannot be selected.



■ Examples of pause conditions

- The driver unfastened their seatbelt.
- A pedestrian or obstacle is detected.
- The driver depressed the accelerator.
- The driver turned the steering wheel.
- The driver changed the shift position to **D**, **R**, or **N**.
- A door on the vehicle was opened (including the tailgate).

■ Error Messages

If the following condition occurred while using the system, there may be a problem with the system.

Stop the vehicle by depressing the brake pedal, change the shift position to **P** once and manually operate the vehicle after making sure the shift position.

- The screen is not displayed.
-  does not blink.
- The system does not beep.
-  is amber and an error message is displayed on the screen.

■ Honda Parking Pilot Conditions and Limitations

In the following situations, the target position may be misaligned or not detected at all, or the vehicle may not be able to park.

In addition, in the following situations that the route and turn-back position may not be generated properly, the system may detect obstacles or other things excessively and cancel the operation, or the vehicle may not be possible to stop before hitting an obstacle.

■ Environmental conditions

- The parking space boundary lines are faded or dirty
- The parking space is outlined by rope, blocks, tile, etc.
- There is not much contrast between the pavement and parking space boundary lines.
- The parking space boundary lines are extremely thick, thin or short.
- Only one parking space boundary line can be seen.
- When the parking space is too wide or narrow.
- The parking area is too close or far from where you have stopped.

- The pavement of the parking area is not all one colour, or is uneven.
- There are shadows, paint, redrawn lines, etc. that look like parking space boundaries.
- The parking space boundaries are difficult to see, such as when parking at night or in dark indoor parking.
- Sunshine or lighting is reflected off of part or all of the pavement due to coating, etc.
- Sunlight, such as during sunrise or sunset, directly or indirectly enters the camera.
- It is difficult to see the boundary lines due to piled up snow, snow melting agents, etc.
- Shadows of adjacent objects (trees, buildings, guard rails vehicles, etc.) are parallel to the parking vehicle or parking space.
- There are holes, grooves, cliffs or protrusions.
- There are other vehicles with sonar sensors or other ultrasound-emitting objects close by.
- Driving in bad weather (rain, fog, snow, etc.).
- When similar shapes such as multiple window sashes are lined up in the building.
- Flaps, wheel stoppers, or other structures used in coin-operated parking lots.

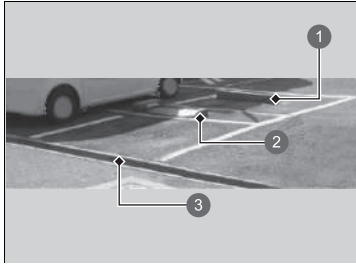

- ① Wheel Stopper
- ② Coin Park Flap
- ③ Different Level

■ Vehicle conditions

- The vehicle is stopped at an angle to the parking space.
- The front of the camera is covered by dirt, fog, rain, mud, wet snow, seals, accessories, stickers, or film of the camera lens.
- The sonar sensors are dirty (covered with snow, ice, mud, etc.)
- The sonar sensors or damaged to facing the wrong direction.
- The vehicle is too hot or cold.
- The vehicle is tilted due to a heavy load in the cargo space or rear seat.
- An abnormal tyre or wheel condition (wrong sized, varied size or construction, improperly inflated, etc.).

■ Obstacle conditions

- Obstacles that do not reflect sound waves well, such as people, snow, cloth, sponges, etc.
- Thin obstacles such as fences, chains, bicycles, sign posts, etc.
- Short or small obstacles.
- Curbs, parking curbs, level differences and other obstacles attached to the pavement.
- Obstacles immediately in front of the bumper.
- Obstacles such as walls that are not perpendicular to the ground.
- Moving objects or obstacles that suddenly enter the road.
- A sloped pillar or wall protruding from a high position.
- Specially-shaped obstacles, including other vehicles.
- The other vehicle is narrow.
- Ground clearance is high because the other vehicle is extremely low.
- Obstacles to the side of the vehicle.
- Obstacles, including other vehicles, too close or far from the vehicle.

Before Charging

Check the following items before you start charging your vehicle.

■ Safety Checklist

- Make sure you plug the charging cable directly into the wall outlet dedicated to vehicle charging.
 - ▶ Do not use extension cords, adaptors, or multi-outlet plugs between the charging cable and the outlet.
- Make sure the charging cable is fully uncoiled before use.
- Make sure the control box, charging connector, and charging cable are free from any damage, including cracks or frays.
 - ▶ If you find any damage to the devices, contact a dealer.
- Make sure the charging connector and inlet are clean.
 - ▶ If you find any contamination or foreign object in the connector or inlet, contact a dealer.
- Make sure the charging cable is dry.
 - ▶ Check that there is no water in the immediate area, and that your hands are dry.

Note: Outlet needs to be in good shape. Worn or damaged outlet will not make good contact with the plug. Ensure that the plug is fully inserted and does not come out of the outlet after installation. A loose connection will cause excessive heat build up within the plug and damage it.

Charge the High Voltage battery using a AC or CCS2 DC charger

There are two ways to charge the High Voltage battery; by using a professionally installed AC 230 volt or CCS2 DC charger.

Charging with	Suggested charging time
CCS2 DC	30 minutes (80% charge)* ¹
AC 230V (32amp)	5-10.5 hours (full charge)* ¹

* 1: Charging time varies depending on conditions, such as the remaining battery level and the ambient temperature.

The suggested full charging time in this table indicates the hours it may likely take for the High Voltage battery to be fully charged from the moment the low charge indicator comes on with the ambient temperature at 77°F (25°C).

⚡ Charging

When the battery warming system is activated, the battery may take longer to charge.

When the 12-volt battery is disconnected, vehicle charging is not possible. After reconnecting the 12-volt battery, turn the power system on, then turn it off.

Confirm that charging is possible.

➤ **Turning on the Power** P. 379

⚠ WARNING

Charging the High Voltage battery under the following conditions is a potential source of electric shock and fire, which can result in serious injury or death:

- Charging the battery during an electric storm.
- Using the charging cable near water or handling with wet hands.
- Using a charger, whose case is broken or cracked or whose cable is frayed or damaged.

Never charge the vehicle in any of the above situations.

⌘ Charging

Before using a vehicle charging cable, inspect the cable for damage such as scratches, cracks, or tears. If you find any damage, do not use the charging cable; instead, take it to a dealer for inspection.

If a blackout or other electrical interruption occurs during vehicle charging, the vehicle will automatically resume charging once power is restored.



To avoid damage to the charger, take these precautions:

- Do not hit the charging connector components with a hard object or drop them on the ground.
- Do not pull, twist, tangle, drag or step on the charging cable.
- Do not use or store near any sources of heat.
- Do not expose to liquids or use harsh chemicals to clean.

You can use the climate control system or audio in the vehicle while charging it. If the power system is activated while charging, you can power functions such as the climate control system, AC power outlet, audio, seat heater.

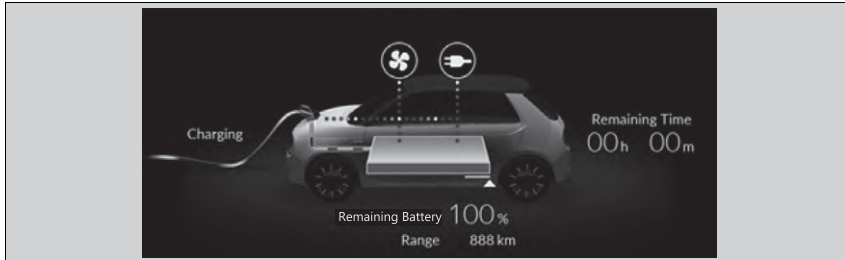
🔌 **Power Flow** P. 313



When using the climate control system or the indoor outlet,  or  is displayed. Using them may cause your vehicle to charge more slowly.

⚡ Charging

⚠ WARNING

Using a charger that is damaged or modified can cause electrical shock and fire, which can result in serious injury or death.

Never disassemble or modify the charger. If the charger becomes damaged, stop using it and consult a dealer.

NOTICE

Do not charge the vehicle with a vehicle cover on. It can cause a malfunction and damage the vehicle or charging components.

Inspect the charging cable plug and charging connector, as well as the vehicle's charge inlet, before use. If the plug or connector are dirty or otherwise contaminated, carefully clean them with a dry clean cloth before use. Do not wipe the metal part of the inlet and the charging connector. Also, if you are unable to clean the plug or connector, if the inlet is dirty, or if any are damaged or corroded, take the charging cable and vehicle to a dealer for inspection and possible repair.

■ How to Charge (AC)



- ❶ Charge Lid Release Button
- ❷ Lid Open Button

1. Stop your vehicle at a station specific for electric vehicles. Park with the charge lid closest to the charge plug, just in front of the bonnet.
2. Put the transmission into **P**
3. Turn off the power system.
4. Press and hold the charge lid release button or lid open button.
 - ▶ The lid opens.
 🔑 **Key** P. 172
 - ▶ The charge lamp (white) inside the charge lid comes on for about 100 seconds.

▣ How to Charge (AC)

Charging equipment with the following identifier is compatible with AC charging.

🔑 **Label Locations** P. 103

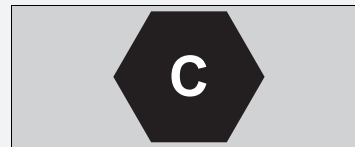

The charge speed slows down towards the completion of the battery charging.

The charge lid can also be opened by audio/information screen.

🔑 **EV Menu** P. 317

The High Voltage battery may not be charged even if the charge connector is properly connected to the vehicle's inlet when the charging timer is set but the timer has not yet started.

Be sure to follow the instructions and safety precautions provided with the AC charging equipment.

If you unplug the charging connector from the inlet, charging cancels automatically.

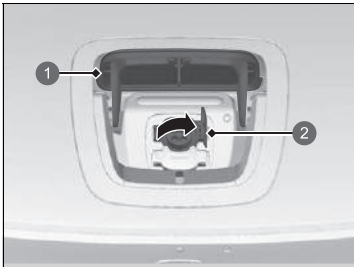

- 1 Charge Lid
- 2 Inlet Cap

- 5. Open the charge lid.
- 6. Open the inlet cap.



- 1 Charge Lamp (blue)

- 7. To connect the cable to the vehicle.
 - ▶ The charge lamp on the charge lid blinks (blue).

▶▶ How to Charge (AC)

Lid open button control

When vehicle is locked

Press lid open button with keyless remote.

When vehicle is unlocked

Press lid open button.

To avoid damage to the charger, take these precautions:

- Do not hit the charge connector components with a hard object or drop them on the ground.
- Do not pull, twist, tangle, drag or step on the charging cable.
- Do not use or store near any sources of heat.
- Do not expose to liquids or use harsh chemicals to clean.

If the charging connector does not disengage, do not engage it forcefully, and follow the procedures mentioned in the following page.

▶▶ **If You Cannot Disengage the Charging Connector** P. 669

Charge connector release control

When vehicle is locked

Press the release button with keyless remote.

When vehicle is unlocked

Press the release button.

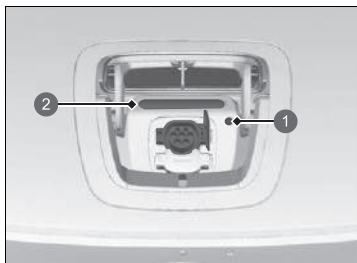

- ① Release Button
- ② Charge Lamp (blue)

■ When charging is completed

Press the release button to disengage the charging connector from the inlet.

- ▶ Make sure to put the cover back on the inlet before you close the lid.

The charge lamp on the charge lid change to blue.

☒ How to Charge (AC)

If the doors are locked, the charging connector cannot be disengaged unless you carry the keyless remote.

To disengage it, unlock the doors.

If you do not disengage it within 30 seconds of unlocking the doors, the charging connector will automatically relock.

Using a Timer

You can set the timer for the High Voltage battery charge using the audio/information screen.

The vehicle begins charging except at the scheduled time when the charging connector is connected to the vehicle.

🔧 **Charging Wait Time Schedule Setting** P. 318

Audio/information screen

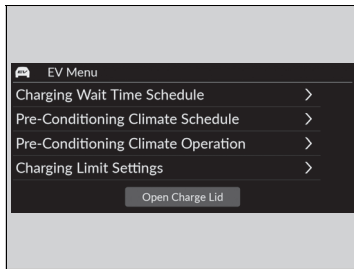

1. Select **EV Menu** icon, then select **Charging Wait Time Schedule**.

▶ The **Charging Wait Time Schedule** can not be set when you do not have the GPS after reconnecting the 12-volt battery. Move to an appropriate communication environment and set the schedule again.

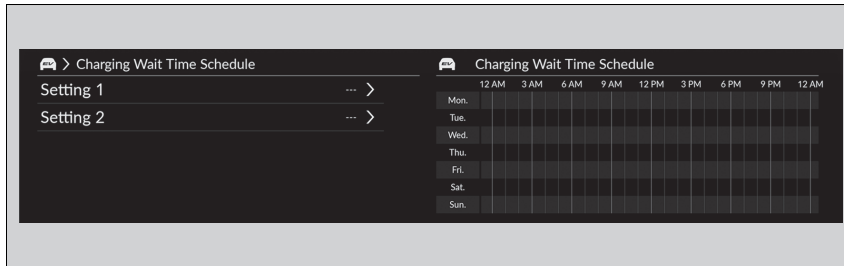

2. Select **Setting 1** or **Setting 2**.

Using a Timer

When the battery warming system is activated, it may not be sufficiently charged.

Audio/information screen

Start/End Time: The battery will be charged except at the time during you have designated not to start.

Start Date: The battery will be charged except at the time during you have designated not to start.

Location: Select **HOME** or **Anywhere**.

▶ **HOME** may be selected when your vehicle is charged at near your home. If so, charge your vehicle using the key fob.

▶ **Anywhere** will be selected when the location of your home is not registered.

ON/OFF: Select **ON** or **OFF**.

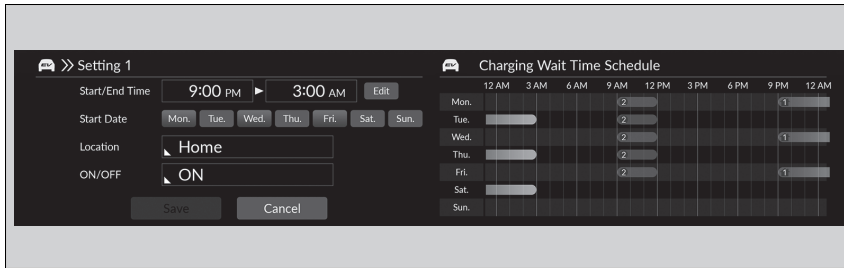

3. Select the item you want to set.

4. Select **Save**.

How to Charge (DC)

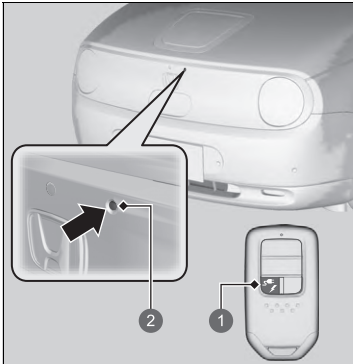

- 1 Charge Lid Release Button
- 2 Lid Open Button

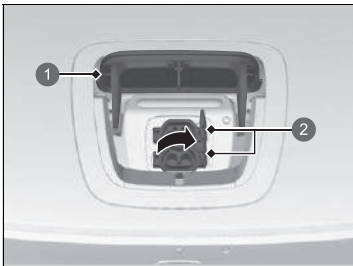

- 1 Charge Lid
- 2 Inlet Cap

1. Stop your vehicle at a station specific for electric vehicles. Park with the charge lid closest to the charge plug, just in front of the bonnet.
2. Put the transmission into **P**.
3. Turn off the power system.
4. Press and hold the charge lid release button or lid open button.
 - ▶ The lid opens.
 - ▣ **Key** P. 172
 - ▶ The charge lamp (white) inside the charge lid comes on for about 100 seconds.
5. Open the charge lid.
6. Open the inlet cap.

How to Charge (DC)

Charging equipment with the following identifier is compatible with DC charging.

▣ **Label Locations** P. 103



Do not use any charging cables longer than 30 m (98.4 ft.).

The charge speed slows down towards the completion of the battery charging.

The charge lid also be opened by audio/information screen.

▣ **EV Menu** P. 317

Be sure to follow the instructions and safety precautions provided with the CCS2 DC charger equipment.

Lid open button control

When vehicle is locked

Press lid open button with keyless remote.

When vehicle is unlocked

Press lid open button.

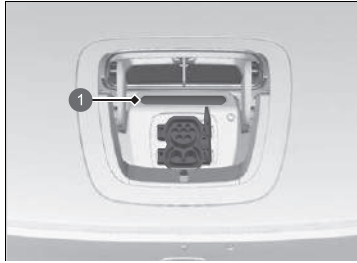

1 Charge Lamp (blue)

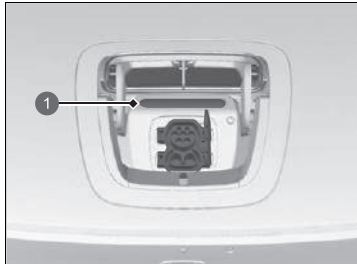

1 Charge Lamp (blue)

7. To connect the cable to the vehicle.

- ▶ The charge lamp on the charge lid blinks (blue).
- ▶ When connecting the charging cable to the vehicle, insert the connector until it hits the back so that it does not tilt.

■ When charging is completed

The charging connector to disengage it from the inlet.

If the charging connector has a release button, press it to release the charging connector from the inlet.

- ▶ Make sure to put the cover back on the inlet before you close the lid.

The charge lamp on the charge lid change to blue.

⌘ How to Charge (DC)

When you want to stop charging, follow the instructions for the use of the charger.

Once the charging is stopped, you can release the charging connector.

If the charging connector does not disengage, do not engage it forcefully, and follow the procedures mentioned in the following page.

⌘ If You Cannot Disengage the Charging Connector P. 669

■ Charge Lamp on the Vehicle Side



① Charge Lamp

Shows the High Voltage battery charging status.

If it blinks for a while, then stays on after the charging connector is plugged in, it indicates that the battery is being charged.

Charge lamp status	Explanation
Blinks slowly (white)	<ul style="list-style-type: none"> • The charger is ready to charge the battery. • Charging is programmed to start using the timer. <ul style="list-style-type: none"> ▶ The charge lamp goes off after about five seconds.
Sweep (blue)	<ul style="list-style-type: none"> • The battery is being charged. • The climate control system is activated with the remote while the charging cable is plugged in.
Stays on (blue)	<ul style="list-style-type: none"> • Charging is complete.
Blinks once after staying on for a few seconds. (blue)	<ul style="list-style-type: none"> • The battery has been fully charged and the battery heating system has been activated.
Blinks rapidly (red)	<ul style="list-style-type: none"> • There is a problem with the charging system. <ul style="list-style-type: none"> ▶ Charging does not start.
Stays on (red)	<ul style="list-style-type: none"> • Charging connector not inserted correctly. <ul style="list-style-type: none"> ▶ When connecting the charging cable to the vehicle, insert the connector until it hits the back so that it does not tilt.
Stays on (white)	<ul style="list-style-type: none"> • When the charging lid is opened. • When the charger's stop button is pressed. • When stopped by the charger timer.

High Voltage Battery

The High Voltage battery gradually discharges even if the vehicle is not in use. As a result, if your vehicle is parked for an extended period of time, the battery level may get low. Keeping your vehicle's battery level low can shorten the battery life, negatively affecting the vehicle's range. To maintain the battery while the vehicle is not in use, recharge the battery at least once every three months.

The High Voltage battery life can also be affected by ambient temperature. In particular, when it is cold outside, the vehicle's driving range can be reduced, and a longer battery charging time is required. In addition, parking in extremely hot or cold environments can accelerate battery drain.

To help extend the lifespan of the battery, it is recommended that you fully charge the battery each time prior to driving.

■ Battery Warming System

Designed to prevent the temperature of the battery from dropping when outside temperatures drop, thereby maintaining starting and running efficiency.

When outside temperatures are low, the battery warming system will use the power from the charging equipment to maintain the temperature of the battery until the next time the vehicle is driven.

⌘ High Voltage Battery

The High Voltage battery drains over time, and under some conditions, drains faster. When the battery life is shortened, this changes the vehicle's driving distance.

⌘ Battery Warming System

If the temperature of the High Voltage battery drops to -30°C or below, the power system will not start. Wait for the High Voltage battery to warm up or move the vehicle to a warmer location. Note using the battery heating system will not help in this case.

Maximum Charge Setting

You can use the audio/information screen to change the maximum charge limit of the high voltage battery when using AC charging equipment.

📖 **Charging Limit Settings** P. 321

If the charge station is located up on a hill, you do not need to fully charge the vehicle at the station. This is because additional electrical energy can be stored in the High Voltage battery as the motor acts an electric generator while going down a hill.

■ Settings on the audio/information screen

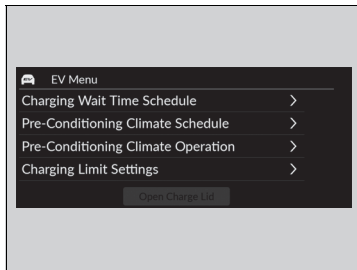

1. Select **EV Menu**.
2. Select **Charging Limit Settings**.

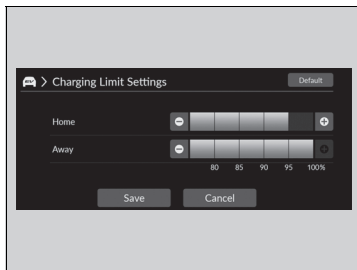

3. Select **Home** or **Away**.
 - ▶ You can set the maximum charge setting based on the location of the vehicle when charging.
- Home:** The location set as home
- Away:** Any other location
4. Choose your preferred charge amount.
5. Select **Save**.

📖 Settings on the audio/information screen

The maximum charge limit is only applicable to AC charging. To charge with the charge amount set in **Home**, you need to register the home position with navigation system.

Improving Energy Economy

Achieving energy economy is dependent on several factors, including driving conditions, load weight, driving habits, and vehicle condition.

Depending on these and other factors, you may not achieve the rated energy economy of this vehicle.

Maintenance and Energy Economy

You can optimize your energy economy with proper maintenance of your vehicle. Always maintain your vehicle in accordance with the messages displayed on the driver information interface.

- Maintain the specified tyre pressure.
- Do not load the vehicle with excess cargo.
- Keep your vehicle clean. A buildup of snow or mud on your vehicle's underside adds weight and increases wind resistance.

Maintenance

This chapter discusses basic maintenance.



Before Performing Maintenance

Inspection and Maintenance	572
Safety When Performing Maintenance	573
Parts and Fluids Used in Maintenance	
Service	574
About Your Maintenance Service	575
Service Reminder System*	576
Maintenance Schedule*	581
Maintenance Under the Bonnet	
Maintenance Items Under the Bonnet	585
Opening the Bonnet	586
Cooling System	588

Transmission Fluid	590
Brake Fluid	591
Refilling Window Washer Fluid	593
Replacing Light Bulbs	594
Checking and Maintaining Wiper	
Blades	598
Checking and Maintaining Tyres	
Checking Tyres	603
Wear Indicators	604
Tyre Service Life	604
Tyre and Wheel Replacement	605
Tyre Rotation	606

Snow Traction Devices	607
12-Volt Battery	608
Remote Transmitter Care	
Replacing the Button Battery	614
Climate Control System Maintenance ..	616
Cleaning	
Interior Care	620
Exterior Care	623
Accessories and Modifications	626

* Not available on all models

Inspection and Maintenance

For your safety, perform all listed inspections and maintenance to keep your vehicle in good condition. If you become aware of any abnormality (noise, smell, insufficient brake fluid, oil residue on the ground, etc.), have your vehicle inspected by a dealer. Refer to the service information available for your vehicle/maintenance schedule in this owner's manual for detailed maintenance and inspection information.

➤ **Maintenance Schedule*** P. 581

Types of Inspection and Maintenance

■ Daily inspections

Perform inspections before long distance trips, when washing the vehicle, or when charging.

■ Periodic inspections

- Check the brake fluid level monthly.
 - **Brake Fluid** P. 591
- Check the tyre pressure monthly. Examine the tread for wear and foreign objects.
 - **Checking and Maintaining Tyres** P. 603
- Check the operation of the exterior lights monthly.
 - **Replacing Light Bulbs** P. 594
- Check the condition of the wiper blades at least every six months.
 - **Checking and Maintaining Wiper Blades** P. 598

➤ Inspection and Maintenance

At this time all maintenance will only be performed at a dealer.

Safety When Performing Maintenance

Some of the most important safety precautions are given here. However, we cannot warn you of every conceivable hazard that can arise in performing maintenance. Only you can decide whether you should perform a given task.

Maintenance Safety

- To reduce the possibility of fire or explosion, keep cigarettes, sparks, and flames away from the 12-volt battery, all High Voltage system related parts.
- Never leave rags, towels, or other flammable objects under the bonnet.
 - ▶ Heat from the surrounding parts can ignite them, causing a fire.
- To clean parts, use a commercially available degreaser or parts cleaner, not petrol.
- Wear eye protection and protective clothing when working with the 12-volt battery or compressed air.

⚠ Safety When Performing Maintenance

⚠ WARNING

Improperly maintaining this vehicle or failing to correct a problem before driving can cause a crash in which you can be seriously hurt or killed.

Always follow the inspection and maintenance recommendations and schedules in this owner's manual/service information available for your vehicle.

⚠ WARNING

Failure to properly follow maintenance instructions and precautions can cause you to be seriously hurt or killed.

Always follow the procedures and precautions in this owner's manual.

■ Vehicle Safety

- The vehicle must be in a stationary condition.
 - ▶ Make sure your vehicle is parked on level ground, the parking brake is set, and the power system is turned off.
- Be aware that hot parts can burn you.
 - ▶ Make sure to let the power system cool thoroughly before touching vehicle parts.
- Be aware that moving parts can injure you.
 - ▶ Do not activate the power system unless instructed to do so.
Keep your hands and limbs away from moving parts.
- Do not touch the high-voltage battery and wiring (orange).

Parts and Fluids Used in Maintenance Service

The use of Honda genuine parts and fluids is recommended when maintaining and servicing your vehicle. Honda genuine parts are manufactured according to the same high quality standards used in Honda vehicles.

About Your Maintenance Service

If the service reminder system is available in your vehicle, you are informed by the driver information interface when your vehicle's maintenance services are due. Refer to the service information available for your vehicle for an explanation of the service item codes that appear on the display.

📖 **Service Reminder System*** P. 576

If the service reminder system is not available, follow the maintenance schedules in the service book* that came with your vehicle.

If your vehicle is without the service book*, follow the maintenance schedule in this owner's manual.

📖 **Maintenance Schedule*** P. 581

📖 About Your Maintenance Service

Models with service reminder system

If you are planning to take your vehicle outside the service reminder system applied countries, consult a dealer for how to record your service reminder information and schedule your maintenance service under the conditions of that country.

* Not available on all models

Service Reminder System*



Provides information of which service items are to be performed. Service items are represented by a code and icon. The system tells you when to take your vehicle to a dealer by days remaining.

When the next maintenance service timing is near, coming or passed, a warning icon will also appear on the driver information interface every time you set the power mode to ON.

Service Reminder System*

You can choose to have a corresponding warning message displayed with the warning icon on the driver information interface.

■ Displaying the Service Reminder Information

1. Set the power mode to ON.
2. Press the  (home) button.
3. Roll the left selector wheel until  is displayed.
4. Press the left selector wheel to go to the service reminder information screen. The maintenance item(s) appears on the driver information interface along with maintenance items due soon.

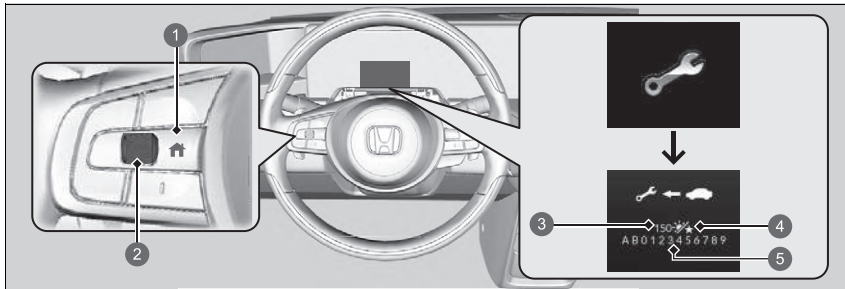

- ①  (home) Button
- ② Left Selector Wheel
- ③ Remaining Days
- ④ Day Icon
- ⑤ Maintenance Item Code(s)







The system message indicator (①) comes on along with the service reminder information.

▣ Displaying the Service Reminder Information

Based on motor operating conditions, the system calculates the remaining days before the next service is to be performed.

If the system calculates that the indicated time for the next maintenance service comes earlier than the indicated distance, the service reminder information display changes to show the remaining days.

Warning Icons and Service Reminder Information on the Driver Information Interface

Warning Icon	Service Reminder Information	Explanation	Information
<p>Service Due Soon</p> 		<p>One or more of the service items are required in less than 30 days. The remaining days are estimated based on your driving conditions.</p>	<p>The remaining days will be counted down per day.</p>
<p>Service Due Now</p> 		<p>One or more of the service items are required in less than 10 days. The remaining days are estimated based on your driving conditions.</p>	<p>Have the indicated service performed as soon as possible.</p>
<p>Service Over Due</p> 		<p>The indicated maintenance service is still not done after the remaining time reaches 0.</p>	<p>Your vehicle has passed the service required point. Immediately have the service performed and make sure to reset the service reminder system.</p>

■ Service Reminder Items

Service items displayed on the driver information interface are in code and icon. For an explanation of the service reminder codes and icons, refer to the service information available for your vehicle.

■ Availability of the Service Reminder System

Even if the service reminder information appears on the driver information interface while pressing the  (home) button, this system is not available in some countries. Refer to the service information available for your vehicle, or ask a dealer if you can use the service reminder system.



☒ Availability of the Service Reminder System

If you are planning to take your vehicle outside the service reminder system applied countries, consult a dealer on how to record your service reminder information and schedule your maintenance service under the conditions of that country.

Continued

■ Resetting the Display

Reset the service reminder information display if you have performed the maintenance service.

1. Set the power mode to ON.
2. Press the  (home) button.
3. Roll the left selector wheel until  is displayed.
4. Press the left selector wheel to go to the service reminder information screen.
5. Press and hold the left selector wheel for about 10 seconds.
6. Roll the left selector wheel select **Reset** (You can also select **Cancel** to end the process).
7. Press the left selector wheel to reset the selected item.
8. Repeat from step 5 for other items you wish to reset.

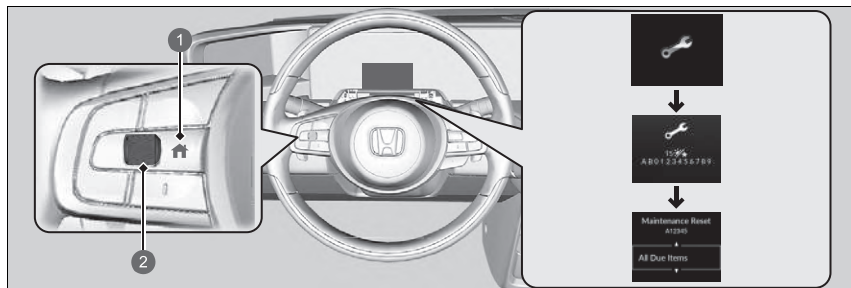

- 1  (home) Button
- 2 Left Selector Wheel

▶▶ Resetting the Display

NOTICE

Failure to reset the service reminder information after a maintenance service results in the system showing incorrect maintenance intervals, which can lead to serious mechanical problems.

You can reset also the service reminder system information display using the audio/information screen.

 **Customized Features** P. 323

The dealer will reset the service reminder information display after completing the required maintenance service. If someone other than a dealer performs maintenance service, reset the service reminder information display yourself.

Maintenance information for your vehicle can be found with the service information for your vehicle (if available). If service information is not available, refer to the following maintenance schedules.

The maintenance schedule outlines the minimum required maintenance that you should perform to ensure the troublefree operation of your vehicle. Due to regional and climatic differences, some additional servicing may be required. Please consult your warranty booklet for a more detailed description.

Maintenance work should be performed by properly trained and equipped technicians. Your authorised dealer meets all of these requirements.

Models without service information for your vehicle

Service at the indicated distance or time - whichever comes first.	km X 1,000	20	40	60	80	100	120	140	160	180	200
	miles X 1,000	12.5	25.0	37.5	50.0	62.5	75.0	87.5	100.0	112.5	125.0
	months	12	24	36	48	60	72	84	96	108	120
Replace transmission fluid	Normal	Every 100,000 km (62,500 miles)									
	Severe	Every 50,000 km (31,000 miles)									
Replace dust and pollen filter		•	•	•	•	•	•	•	•	•	•
Inspect front and rear brakes		Every 10,000 km (6,000 miles) or 1 year									
Replace brake fluid		Every 3 years									
Check expiry date for tyre repair kit bottle		Every year									
Visually inspect the following items:											
Driveshaft boots	Every 10,000 km (6,000 miles) or 1 year										
Tie rod ends, steering gear box, and boots											
Suspension components											
Brake hoses and lines (including ABS/VA)	•	•	•	•	•	•	•	•	•	•	•
All fluid levels and condition of fluid	•	•	•	•	•	•	•	•	•	•	•
Under body battery cover	•	•	•	•	•	•	•	•	•	•	•

Models without service information for your vehicle

If you drive your vehicle under severe conditions, you must have the following items served to the maintenance schedule indicated as Severe.

Items	Condition
Transmission fluid	B and D

⌘ Maintenance Schedule*

The condition is considered as severe when you drive:
 B. In extremely hot temperature above 35°C.
 D. With a loaded roof rack, or in mountains.

* Not available on all models

Maintenance Record (on vehicles without separate service record)

Have your servicing dealer record all required maintenance below. Keep receipts for all work done on your vehicle.

Km or Month	Date	Sign or Stamp
20,000 km 12,500 Mi. (or 12 Mo.)		
40,000 km 25,000 Mi. (or 24 Mo.)		
60,000 km 37,500 Mi. (or 36 Mo.)		
80,000 km 50,000 Mi. (or 48 Mo.)		
100,000 km 62,500 Mi. (or 60 Mo.)		
120,000 km 75,000 Mi. (or 72 Mo.)		
140,000 km 87,500 Mi. (or 84 Mo.)		
160,000 km 100,000 Mi. (or 96 Mo.)		
180,000 km 112,500 Mi. (or 108 Mo.)		
200,000 km 125,000 Mi. (or 120 Mo.)		

Maintenance Items Under the Bonnet

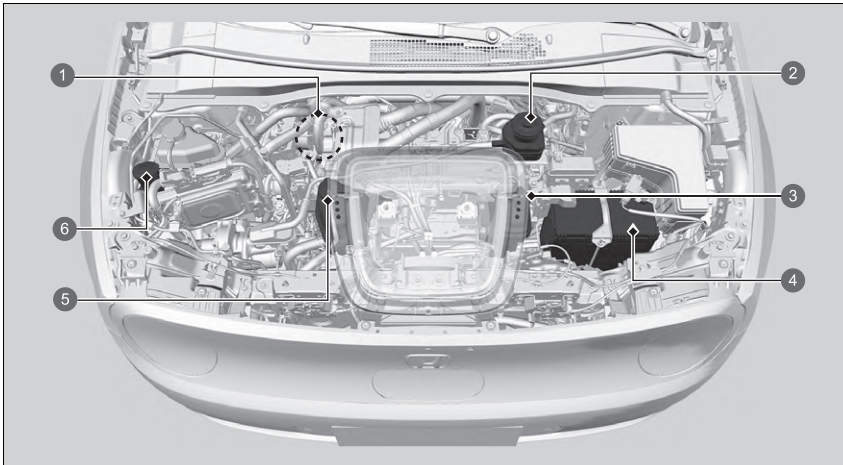

- 1 Brake Fluid (Black Cap) (Right-hand Drive Type)
- 2 Brake Fluid (Black Cap) (Left-hand Drive Type)
- 3 PCU Coolant Reserve Tank
- 4 12-Volt Battery
- 5 IPU Coolant Reserve Tank
- 6 Washer Fluid (Blue Cap)

Opening the Bonnet

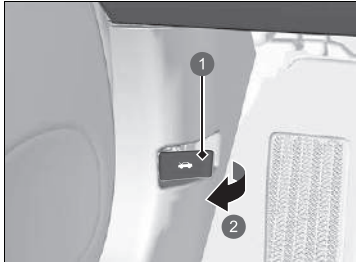

- 1 Bonnet Release Handle
- 2 Pull

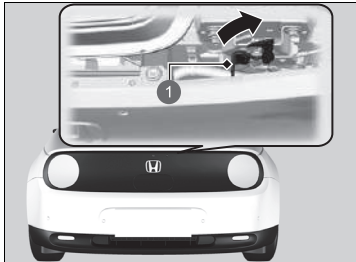

- 1 Lever

1. Park the vehicle on a level surface, and set the parking brake.
2. Pull the bonnet release handle under the driver's side lower outside corner of the dashboard.
 - The bonnet will pop up slightly.

3. Push the bonnet latch lever (located under the front edge of the bonnet) to the side and raise the bonnet. Once you have raised the bonnet slightly, you can release the lever.

► Opening the Bonnet

NOTICE

Do not open the bonnet when the wiper arms are raised. The bonnet will strike the wipers, resulting in possible damage to the bonnet and/or the wipers.

When closing the bonnet, check that the bonnet is securely latched.

If the bonnet latch lever moves stiffly, or if you can open the bonnet without lifting the lever, the latch mechanism should be cleaned and lubricated.

The radiator fans and the climate control system will not operate when the bonnet is open and the climate control system is turned on with the remote transmitter.



4. Lift the bonnet up most of the way.
 - The hydraulic supports will lift it up the rest of the way and hold it up.

When closing, gently lower the bonnet, and remove your hand at a height of approximately 12 inches (30 cm) and let the bonnet close.

✘ Opening the Bonnet

When closing the bonnet, check that both right and left latches are securely latched.

Do not close the bonnet by grabbing the charge lid opening.

Cooling System

Specified coolant: Honda Genuine Coolant

Coolant is used to reduce the temperature of the high voltage battery, power control unit and related parts. When checking the coolant level, make sure to follow the procedures listed below. If the coolant level is below the **MIN** mark, have your vehicle inspected by a dealer.

■ Checking the PCU Coolant Level

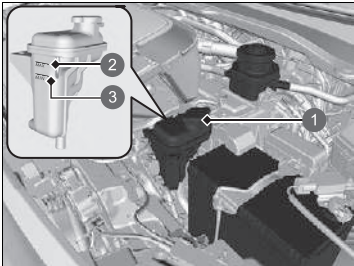

1. Check the fluid level in the tank.
2. If the coolant level has dropped below the **MIN** level, have your vehicle serviced at a dealer.
 - Only a properly trained technician can refill the coolant and check the system for leaks.

- 1 Reserve Tank
- 2 **MAX**
- 3 **MIN**

■ Checking the IPU Coolant Level

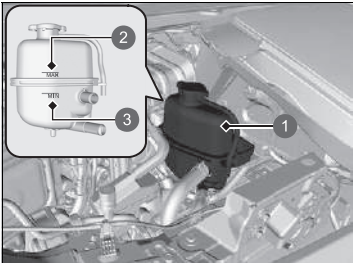

1. Check the fluid level in the tank.
2. If the coolant level has dropped below the **MIN** level, have your vehicle serviced at a dealer.
 - Only a properly trained technician can refill the coolant and check the system for leaks.

- ① Reserve Tank
- ② **MAX**
- ③ **MIN**

■ Radiator Cap



- Never open when hot.
- Hot coolant will scald you.
- Relief pressure valve begins to open at 49 kPa.

Transmission Fluid

Specified fluid: Honda ATF DW-1

Have a dealer check the fluid level and replace if necessary.

Do not attempt to check or change the transmission fluid yourself.

» Transmission Fluid

NOTICE

Do not mix Honda ATF DW-1 with other transmission fluids.

Using a transmission fluid other than Honda ATF DW-1 may adversely affect the operation and durability of your vehicle's transmission, and damage the transmission.

Any damage caused by using a transmission fluid that is not equivalent to Honda ATF DW-1 is not covered by Honda's new vehicle limited warranty.

Brake Fluid

Specified fluid: Brake Fluid with DOT 3 or DOT 4

Checking the Brake Fluid

Left-hand Drive Type

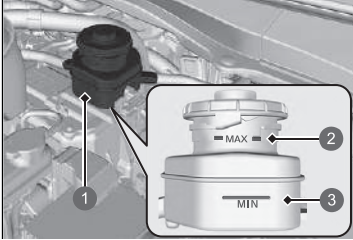

- ① Reserve Tank
- ② **MAX**
- ③ **MIN**

The fluid level should be between the **MIN** and **MAX** marks on the side of the reserve tank.

Brake Fluid

NOTICE

Brake fluid marked DOT 5 is not compatible with your vehicle's braking system and can cause extensive damage.

We recommend using a genuine product.

If the brake fluid level is at or below the **MIN** mark, have a dealer inspect the vehicle for leaks or worn brake pads as soon as possible.

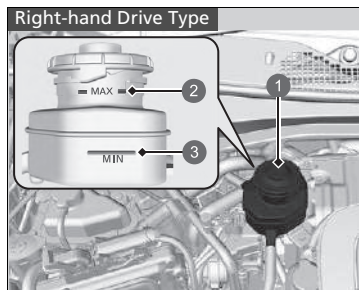

- ① Reserve Tank
- ② **MAX**
- ③ **MIN**

Refilling Window Washer Fluid

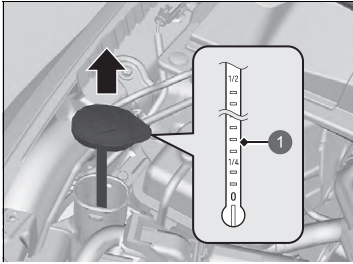

① Level Gauge

Check the amount of window washer fluid using the washer fluid level gauge on the cap.

If the level is low, fill the washer reservoir.

Pour the washer fluid carefully. Do not overflow the reservoir.

ⓘ Refilling Window Washer Fluid

NOTICE

Do not use motor antifreeze or a vinegar/water solution in the windscreen washer reservoir. Antifreeze can damage your vehicle's paint. A vinegar/water solution can damage the windscreen washer pump.

Use only commercially available windscreen washer fluid.

Avoid prolonged use of hard water to prevent lime scale build up.

Headlights

Headlights are LED type. Have a dealer inspect and replace the light assembly.

Front Fog Lights

Front fog lights are LED type. Have a dealer inspect and replace the light assembly.

Position/Daytime Running Lights

Position/daytime running lights are LED type. Have a dealer inspect and replace the light assembly.

Front Turn Signal Lights

Front turn signal lights are LED type. Have a dealer inspect and replace the light assembly.

Side Turn Signal/Emergency Indicator Lights

Side turn signal lights are LED type. Have a dealer inspect and replace the light assembly.

Brake/Taillight and Rear Turn Signal Lights

Brake/taillight and rear turn signal lights are LED type. Have a dealer inspect and replace the light assembly.

Headlights

The headlight aim is set by the factory, and does not need to be adjusted. However, if you regularly carry heavy items in the luggage area, have the aiming readjusted at a dealer or by a qualified technician.

Rear Licence Plate Light

Rear licence plate light is LED type. Have a dealer inspect and replace the light assembly.

High-Mount Brake Light

High-mount brake light is LED type. Have a dealer inspect and replace the light assembly.

Back-Up Lights and Rear Fog Light

Back-up lights and rear fog light are LED type. Have a dealer inspect and replace the light assembly.

Door Outer Handle Ambient Lights

Door outer handle ambient lights are LED type. Have a dealer inspect and replace the light assembly.

Charge Lamp

Charge lamp is LED type. Have a dealer inspect and replace the light assembly.



① Charge Lamp

Other Light Bulbs

■ Vanity Mirror Light Bulbs

When replacing, use the following bulbs.

Vanity Mirror Light: 1.8 W

1. Pry on the edge of the cover using a flat-tip screwdriver to remove the cover.
 - ▶ Wrap the flat-tip screwdriver with a cloth to prevent scratches.

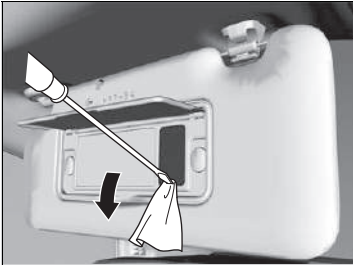

2. Remove the old bulb and insert a new bulb.



- 1 Bulb

Checking Wiper Blades

If the wiper blade rubber has deteriorated, it will leave streaks and the hard surfaces of the blade may scratch the window glass.

Changing the Front Wiper Blade Rubber



1. Set the power mode to VEHICLE OFF.
2. Within 10 seconds of setting the power mode to VEHICLE OFF, hold the wiper switch in the **MIST** position for more than two seconds.
 - ▶ Both wiper arms are set to the maintenance position as shown in the image.
3. Lift both wiper arms.

Changing the Front Wiper Blade Rubber

NOTICE

Avoid dropping the wiper arm onto the windshield, it may damage the wiper arm and/or the windshield.

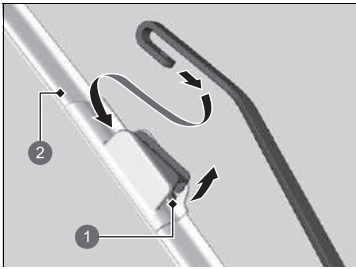

- ① Tab
- ② Holder

4. Press up on and hold the tab, then slide the holder off the wiper arm.

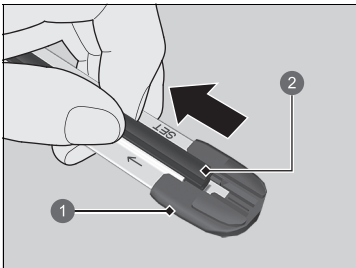

- ① End Cap at the bottom
- ② Blade

5. Pull the end of the wiper blade in the direction of the arrow in the image until it is out of the holder's end cap.

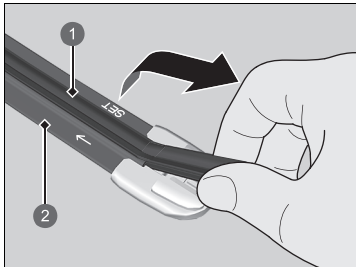

- 1 Blade
- 2 Holder

6. Pull the wiper blade in the opposite direction to slide it out of the holder.

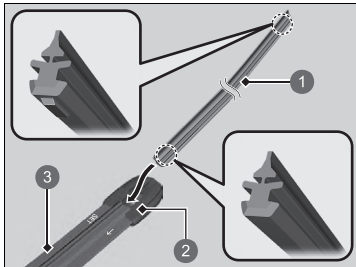

- 1 Blade
- 2 Cap
- 3 Holder

7. Insert the flat side of the new wiper blade onto the bottom part of the holder. Insert the blade all the way.

8. Install the end of the wiper blade into the cap.

9. Slide the holder onto the wiper arm until it locks.

10. Lower both wiper arms.

11. Set the power mode to ON and hold the wiper switch in the **MIST** position until both wiper arms return to the standard position.

Changing the Rear Wiper Blade Rubber

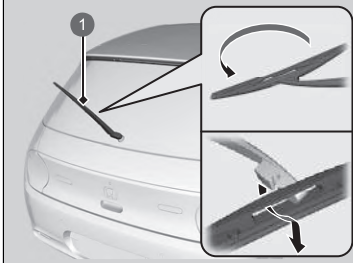

1. Raise the wiper arm off.
2. Pivot the bottom end of the wiper blade up until it comes off from the wiper arm.

1 Wiper Arm

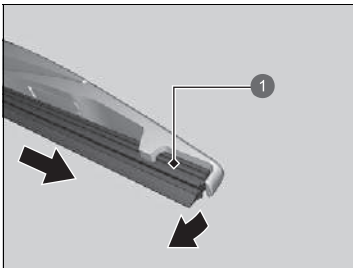

3. Slide the blade out of the wiper.

1 Blade

Changing the Rear Wiper Blade Rubber

NOTICE

Avoid dropping the wiper arm; it may damage the rear window.

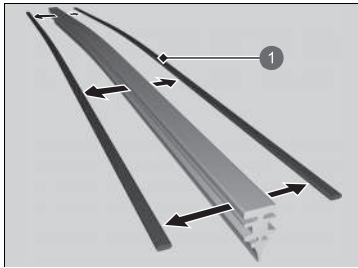

1 Retainer

4. Remove the retainers from wiper blade and mount to a new rubber blade.

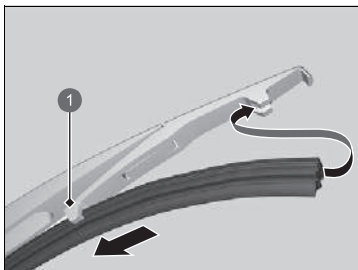

1 Holder

5. Slide the new wiper blade onto the holder.
 - Make sure it is engaged correctly, then install the wiper blade assembly onto the wiper arm.

Checking Tyres

To safely operate your vehicle, your tyres must be of the proper type and size, in good condition with adequate tread, and properly inflated.

■ Inflation guidelines

Properly inflated tyres provide the best combination of handling, tread life, and comfort. Refer to the driver's doorjamb label for the specified pressure.

Underinflated tyres wear unevenly, adversely affect handling and energy economy, and are more likely to fail from overheating.

Overinflated tyres make your vehicle ride harshly, are more prone to road hazards, and wear unevenly.

Every day before you drive, look at each of the tyres. If one looks lower than the others, check the pressure with a tyre gauge.

At least once a month or before long trips, use a gauge to measure the pressure in all tyres. Even tyres in good condition can lose 10–20 kPa (0.1–0.2 bar, 1–2 psi) per month.

■ Inspection guidelines

Every time you check inflation, also examine the tyres and valve stems.

Look for:

- Bumps or bulges on the side or in the tread. Replace the tyre if you find any cuts, splits, or cracks in the side of the tyre. Replace it if you see fabric or cord.
- Remove any foreign objects and inspect for air leaks.
- Uneven tread wear. Have a dealer check the wheel alignment.
- Excessive tread wear.

➤ **Wear Indicators** P. 604

- Cracks or other damage around valve stem.

ⓘ Checking Tyres

⚠ WARNING

Using tyres that are excessively worn or improperly inflated can cause a crash in which you can be seriously hurt or killed.

Follow all instructions in this owner's manual regarding tyre inflation and maintenance.

Measure the air pressure when tyres are cold. This means the vehicle has been parked for at least three hours, or driven less than 1.6 km (1 mile). If necessary, add or release air until the specified pressure is reached.

If checked when hot, tyre pressure can be as much as 30–40 kPa (0.3–0.4 bar, 4–6 psi) higher than if checked when cold.

Whenever tyre pressure is adjusted, you must initialise the deflation warning system.

➤ **Deflation Warning System** P. 418

Have a dealer check the tyres if you feel a consistent vibration while driving. New tyres and any that have been removed and reinstalled should be properly balanced.

Wear Indicators

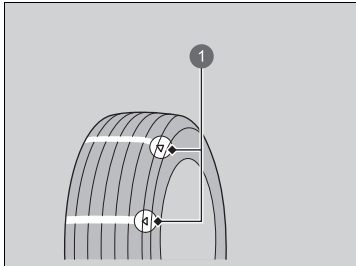

The groove where the wear indicator is located is about 1.6 mm (about 1/16 inch) shallower than elsewhere on the tyre. If the tread has worn so that the indicator is exposed, replace the tyre.

Worn out tyres have poor traction on wet roads.

- 1 Example of a Wear Indicator mark

Tyre Service Life

The life of your tyres is dependent on many factors, including driving habits, road conditions, vehicle loading, inflation pressure, maintenance history, speed, and environmental conditions (even when the tyres are not in use).

In addition to regular inspections and inflation pressure maintenance, it is recommended that you have annual inspections performed once the tyres reach five years old. All tyres should be removed from service after 10 years from the date of manufacture, regardless of their condition or state of wear.

Tyre and Wheel Replacement

Replace your tyres with radials of the same size, load range, speed rating, and maximum cold tyre pressure rating (as shown on the tyre's sidewall). Using tyres of a different size or construction can cause certain vehicle systems such as the ABS and Vehicle Stability Assist (VSA) system to work incorrectly.

It is best to replace all four tyres at the same time. If that isn't possible, replace the front or rear tyres in pairs.

Make sure that the wheel's specifications match those of the original wheels.

ⓘ Tyre and Wheel Replacement

WARNING

Installing improper tyres on your vehicle can affect handling and stability. This can cause a crash in which you can be seriously hurt or killed.

Always use the size and type of tyres recommended in the tyre information label on your vehicle.

Tyre Rotation

The front and rear tyre sizes are different.

Due to this, the front and rear tyres on this vehicle cannot be rotated.

► Tyre Rotation

Directional tyres should be mounted with the rotation indication mark facing forward, as shown below.

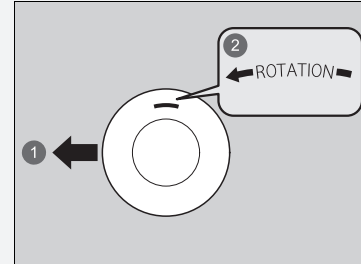

- ① Front
- ② Rotation Mark

Snow Traction Devices

If driving on snowy or frozen roads, mount winter tyres, or tyre chains; reduce speed; and maintain sufficient distance between vehicles when driving.

Be particularly careful when operating the steering wheel or brakes to prevent skidding.

Use tyre chains, winter tyres, or all season tyres when necessary or according to the law.

When mounting, refer to the following points.

For winter tyres:

- Select the size and load ranges that are the same as the original tyres.
- Mount the tyres to all four wheels.

For tyre chains:

- Consult a dealer before purchasing any type of chains for your vehicle.
- Install them on the rear tyres only.
- Because your vehicle has limited tyre clearance, we strongly recommend using the chains listed below:

Original Tyre Size*1	Chain Type
205/55R16 91V	RUD-matic classic 48484
225/45ZR17 (94Y)	RUD-matic classic 48489

*1: Original tyre size is mentioned on the tyre information label on the driver's doorjamb.

- Follow the chain manufacturer's instruction when installing. Mount them as tightly as you can.
- Check that the chains do not touch the brake lines or suspension.
- Drive slowly.

❗ Snow Traction Devices

⚠ WARNING

Using the wrong chains, or not properly installing chains, can damage the brake lines and cause a crash in which you can be seriously injured or killed.

Follow all instructions in this owner's manual regarding the selection and use of tyre chains.

NOTICE

Traction devices that are the wrong size or improperly installed can damage your vehicle's brake lines, suspension, body, and wheels. Stop driving if they are hitting any part of the vehicle.

According to the EU legislation for tyres, when winter tyres are used, it is necessary to affix a sticker with the allowable max. speed of the winter tyres clearly in the field of view of the driver, if the designed max. speed of vehicle is higher than the allowed max. speed of winter tyre. A sticker is obtainable from your tyre dealer. If you have any question, consult a dealer.

When tyre chains are mounted, follow the chain manufacturer's instructions regarding vehicle operational limits.

Use tyre chains only in an emergency or when they are legally required for driving through a certain area.

Use greater caution when driving with tyre chains on snow or ice. They may have less-predictable handling than good winter tyres without chains.

If your vehicle is equipped with summer tyres, be aware that these tyres are not designed for winter driving conditions. For more information, contact a dealer.

Checking the 12-Volt Battery

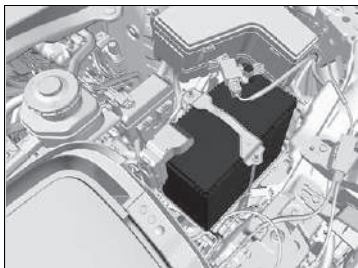

The condition of the battery is monitored by a sensor located on the negative terminal of the battery. If there is a problem with this sensor, the driver information interface will display a warning message. If this happens, have your vehicle inspected by a dealer.

Check the battery terminals for corrosion monthly.

If your vehicle's battery is disconnected or goes dead:

- The audio system is disabled.
 - **Reactivating the audio system** P. 255
- The clock resets.
 - **Clock Setup** P. 273

Right-hand Drive Type

- The immobilizer system needs to be reset.
 - **Immobilizer System Indicator** P. 121

All models

- The vehicle cannot be charged. After reconnecting the battery, turn the power system on, then turn it off. Confirm that charging is possible.
 - **Turning on the Power** P. 379
 - **Charging** P. 556

12-Volt Battery

⚠ WARNING

The battery gives off explosive hydrogen gas during normal operation.

A spark or open flame can cause the battery to explode with enough force to kill or seriously hurt you.

Keep all sparks, open flames, and smoking materials away from the battery.

Wear protective clothing and a face shield, or have a skilled technician do any battery maintenance.

⚠ WARNING

The battery contains sulfuric acid (electrolyte) which is highly corrosive and poisonous.

Getting electrolyte in your eyes or on your skin can cause serious burns. Wear protective clothing and eye protection when working on or near the battery.

Swallowing electrolyte can cause fatal poisoning if immediate action is not taken.

KEEP OUT OF THE REACH OF CHILDREN

⌘ 12-Volt Battery

Emergency Procedures

Eyes: Flush with water from a cup or other container for at least 15 minutes. (Water under pressure can damage the eye.) Call a physician immediately.

Skin: Remove contaminated clothing. Flush the skin with large quantities of water. Call a physician immediately.

Swallowing: Drink water or milk. Call a physician immediately.

When you find corrosion, clean the battery terminals by applying a baking powder and water solution.

Clean the terminals with a damp towel. Cloth/towel dry the battery. Coat the terminals with grease to help prevent future corrosion.

When replacing the battery, the replacement must be of the same specifications.

Consult a dealer for more information.

Charging the 12-Volt Battery

Disconnect both battery cables to prevent damaging your vehicle's electrical system. Always disconnect the negative (-) cable first, and reconnect it last.

Replacing the 12-Volt Battery

When you remove and replace the 12-volt battery, always follow the maintenance safety and the warnings for when checking the battery to prevent potential hazards.

🔧 **Maintenance Safety** P. 573

🔧 **Checking the 12-Volt Battery** P. 608

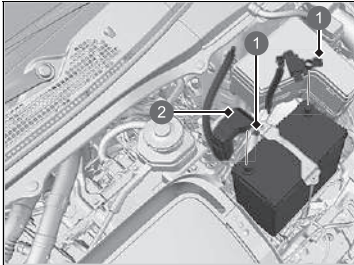

- 1 Nuts
- 2 Cover

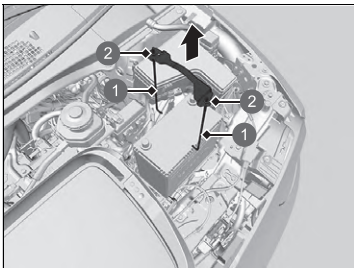

- 1 Stay
- 2 Nut

1. Set the power mode to VEHICLE OFF. Open the bonnet.
2. Loosen the nut on the negative battery cable, then disconnect the cable from the negative (-) terminal.
 - ▶ Do not remove the battery sensor ground cable or connector.
3. Open the positive battery terminal cover. Loosen the nut on the positive battery cable, then disconnect the cable from the positive (+) terminal.
4. Loosen the nut on each side of the battery bracket with a wrench.
5. Pull the bottom end of each battery stay out of the hole on the battery base, and remove the combination of the battery bracket and the stays.

▶▶ Replacing the 12-Volt Battery

NOTICE

An improperly disposed of battery can be harmful to the environment and human health. Always confirm local regulations for battery disposal.

This symbol on the battery means that this product must not be treated as household waste.



To install a new battery, reverse this procedure.

Always disconnect the negative (-) cable first, and reconnect it last.

Continued

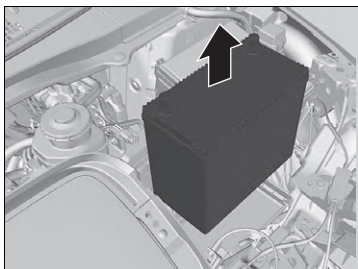

6. Take out the battery carefully.

Battery Label



▶▶ Battery Label

DANGER

- Keep flames and sparks away from the battery. The battery produces explosive gas that can cause an explosion.
- Wear eye protection and rubber gloves when handling the battery to avoid risk of burns or loss of eyesight if exposed to battery electrolyte.
- Do not allow children to handle the battery, under any circumstance. Ensure that anyone handling the battery has a proper understanding of the hazards and correct handling procedures involved.
- Handle battery electrolyte with extreme care, as it contains dilute sulfuric acid. Exposure to eyes or skin can cause burns or loss of eyesight.
- Read this manual carefully, and understand it before handling the battery. Failure to do so can cause personal injury and damage to the vehicle.
- Do not use the battery if the level of electrolyte is at or below the recommended level. Using the battery with low electrolyte can cause it to explode, causing serious injury.

Replacing the Button Battery

If the indicator does not come on when the button is pressed, replace the battery.

▶ Replacing the Button Battery

■ Keyless Remote



Battery type: CR2032

1. Remove the built-in key.

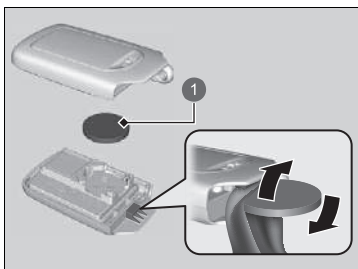

2. Remove the upper half by carefully prying on the edge with a coin.

▶ Wrap a coin with a cloth to prevent scratching the keyless remote.

▶ Remove carefully to avoid losing the buttons.

3. Make sure to replace the battery with the correct polarity.

1 Battery

⚠ ⚠ WARNING

CHEMICAL BURN HAZARD

The battery that powers the remote transmitter can cause severe internal burns and can even lead to death if swallowed. Keep new and used batteries away from children.

If you suspect that a child has swallowed the battery, seek medical attention immediately.

CAUTION: Danger of explosion if battery is incorrectly replaced. Replace only with the same or equivalent type.

CAUTION: Do not exposed to excessive heat such as sunshine, fire or the like, that can result in an explosion or the leakage of flammable liquid or gas during use, storage or transportation.

CAUTION: Do not dispose of a battery into fire or a hot oven, or give mechanically crushing or cutting of a battery, that can result in an explosion.

CAUTION: Do not subjected to extremely low air pressure at high altitude that may result in an explosion or the leakage of flammable liquid or gas.

▶▶ Replacing the Button Battery

A warning mark is located adjacent to the button battery*.

NOTICE

An improperly disposed of battery can damage the environment. Always confirm local regulations for battery disposal.

This symbol on the battery means that this product must not be treated as household waste.



Replacement batteries are commercially available or at a dealer.

* Not available on all models

Air Conditioning

For proper and safe operation of the climate control system, the refrigerant system should only be served by a qualified technician.

Never repair or replace the air conditioning evaporator (cooling coil) with one removed from a used or salvaged vehicle.

Climate Control System Maintenance

NOTICE

Vented refrigerant is harmful to the environment. To avoid refrigerant from venting, never replace the evaporator with one removed from a used or salvaged vehicle.

Refrigerant in your vehicle's air conditioning system is flammable and can be ignited during servicing if proper procedures are not followed.

The air conditioner label is found under the bonnet:

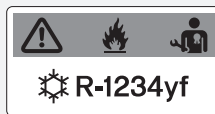

 : Caution

 : Flammable Refrigerant

 : Requires a qualified technician to service

 : Air Conditioning System

 **Safety Labels** P. 103

 **Specifications** P. 672

Dust and Pollen Filter

■ When to Replace the Dust and Pollen Filter

Replace the dust and pollen filter according to your vehicle's recommended maintenance schedule. It is recommended to replace the filter even sooner if the vehicle has been driven in a dusty environment.

📄 **Maintenance Schedule*** P. 581

■ How to Replace the Dust and Pollen Filter

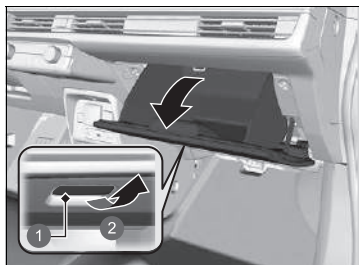

1. Open the glove box.

① Handle

② Pull

☒ Dust and Pollen Filter

If the airflow from the climate control system deteriorates noticeably, and the windows fog up easily, the filter may need to be replaced.

The dust and pollen filter collects pollen, dust, and other debris in the air.

If you are not sure how to replace the dust and pollen filter, have it replaced by a dealer.

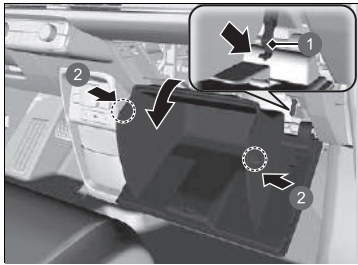

2. Push the stopper on the passenger's side of the glove box to detach it from the glove box.
3. Disengage the two tabs by pushing on each side panel.
4. Pivot the glove box out of the way.

- 1 Stopper
- 2 Tabs

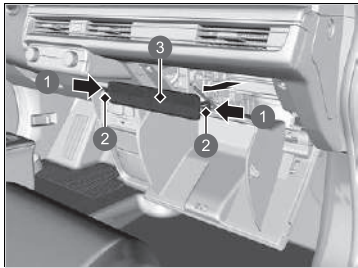

5. Push in the tabs on the corners of the filter case cover, and remove it.

- 1 Push
- 2 Tabs
- 3 Cover

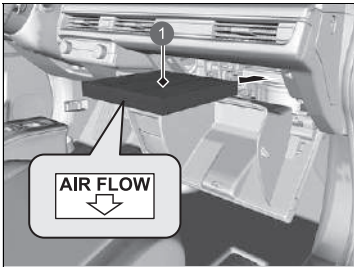

1 Dust and Pollen Filter

6. Remove the filter from the case.
7. Install a new filter in the case.
 - Put the **AIR FLOW** arrow directed side down.

Interior Care

Use a vacuum cleaner to remove dust before using a cloth.

Use a damp cloth with a mixture of mild detergent and warm water to remove dirt.

Use a clean cloth to remove detergent residue.

Cleaning Seat Belts

Use a soft brush with a mixture of mild soap and warm water to clean the seat belts.

Let the belts air dry. Wipe the loops of the seat belt anchors using a clean cloth.



1 Loop

Interior Care

Do not spill liquids inside the vehicle. Electrical devices and systems may malfunction if liquids are splashed on them.

Do not use silicone based sprays on electrical devices such as audio devices and switches. Doing so may cause the items to malfunction or cause a fire inside the vehicle.

If a silicone based spray is inadvertently used on electrical devices, consult a dealer.

Depending on their composition, chemicals and liquid aromatics may cause discolouration, wrinkles, and cracking to resin-based parts and textiles. Do not use alkali solvents or organic solvents such as benzene or petrol.

After using chemicals, make sure to gently wipe them away using a dry cloth.

Do not place used cloths on top of resin based parts or textiles for long periods of time without washing.

Be careful not to spill a liquid type air freshener.

■ Cleaning the Window

Wipe using a glass cleaner.

■ Super UV Cut/IR Cut Glass

The front side windows are laminated with UV-cut and IR-cut film. When cleaning the interior side of the windows, make sure to use a soft damp cloth.

■ Floor Mats*

The front floor mat hooks over the floor anchors, which keep the mat from sliding forward. When reinstalling the mat after cleaning, position it properly.

Do not put additional floor mats on top of the anchored mat.

☒ Cleaning the Window

Wires are mounted to the inside of the rear window. Wipe along the same direction as the wires with a soft cloth so as not to damage them.

Be careful not to spill fluids, such as water or glass cleaner, on or around the cover of both the front sensor camera and the rainfall/light sensor*.

☒ Super UV Cut/IR Cut Glass

To ensure the longevity of the UV-cut and IR-cut film, avoid:

- Opening and closing the windows when they are covered with dirt and other debris.
- Using a glass cleaner containing polishing compounds, wax, or detergents.

☒ Floor Mats*

If you use any floor mats that were not originally provided with your vehicle, make sure they are designed for your specific vehicle, fit correctly, and are securely anchored by the floor anchors. Position the rear seat floor mats properly. If they are not properly positioned, the floor mats can interfere with the front seat functions.

* Not available on all models

■ Maintaining Genuine Leather

To properly clean leather:

1. Use a vacuum or soft dry cloth first to remove any dirt or dust.
2. Clean the leather with a soft cloth dampened with a solution comprised of 90% water and 10% neutral soap.
3. Wipe away any soap residue with a clean damp cloth.
4. Wipe away residual water and allow leather to air dry in the shade.

▣ Maintaining Genuine Leather

It is important to clean or wipe away dirt or dust as soon as possible. Spills can soak into leather resulting in stains. Dirt or dust can cause abrasions in the leather. In addition, please note that some dark coloured clothing can rub onto the leather seats resulting in discolouration or stains.

Exterior Care

Dust off the vehicle body after you drive. Regularly inspect your vehicle for scratches on painted surfaces. A scratch on a painted surface can result in body rust. If you find a scratch, promptly repair it.

■ Washing the Vehicle

Wash the vehicle regularly. Wash more frequently when driving in the following conditions:

- If driving on roads with road salt.
- If driving in coastal areas.
- If tar, soot, bird droppings, insects, or tree sap are stuck to painted surfaces.

■ Using an Automated Car Wash

- Make sure to follow the instructions indicated on the automated car wash.
- Turn off the automatic intermittent wipers.

⌘ Washing the Vehicle

Do not spray water into the air intake vents. It can cause a malfunction.

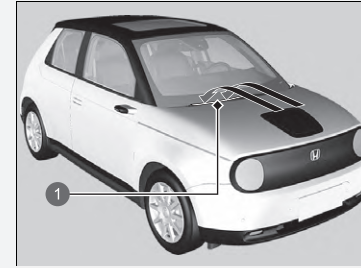

① Air Intake Vents

If you need to lift the wiper arms away from the windscreen, first set the wiper arms to the maintenance position.

➤ **Changing the Front Wiper Blade Rubber**
P. 598

⌘ Using an Automated Car Wash

When using an automated car wash that pulls the vehicle through with a conveyor, make sure vehicle is in car wash mode.

➤ **If you want to keep the transmission in **N** position (car wash mode)** P. 389

■ Using High Pressure Cleaners

- Keep sufficient distance between the cleaning nozzle and the vehicle body.
- Take particular care around the windows. Standing too close may cause water to enter the vehicle interior.
- Do not spray water under the bonnet where the high voltage system components are located. It could cause a malfunction.
- Do not spray water directly at the charging port.

■ Applying Wax

A good coat of automotive body wax helps to protect your vehicle's paint from the elements. Wax will wear off over time and expose your vehicle's paint to the elements, so reapply as necessary.

■ Maintaining the Bumpers and Other Resin Coated Parts

If you get coolant or battery fluid on resin coated parts, they may be stained or the coating may peel. Promptly wipe it away using a soft cloth and clean water.

■ Cleaning the Window

Wipe using a glass cleaner.

✎ Applying Wax

NOTICE

Chemical solvents and strong cleaners can damage the paint, metal, and plastic on your vehicle. Wipe away spills immediately.

✎ Maintaining the Bumpers and Other Resin Coated Parts

Ask a dealer about the correct coating material when you want to repair the painted surface of the parts made of resin.

■ Maintaining Aluminium Wheels

Aluminium is susceptible to deterioration caused by salt and other road contaminants. When necessary, as early as possible use a sponge and mild detergent to wipe away these contaminants. Do not use a stiff brush or harsh chemicals (including some commercial wheel cleaners). These can damage the protective finish on aluminium alloy wheels, resulting in corrosion. Depending on the type of finish, the wheels also may lose their lustre or appear burnished. To avoid water stains, wipe the wheels dry with a cloth while they are still wet.

■ Fogged Exterior Light Lenses

The inside lenses of exterior lights (headlights, brake lights, etc.) may fog temporarily if you have driven in the rain, or after the vehicle has been run through a car wash. Dew condensation also may build up inside the lenses when there is a significant enough difference between the ambient and inside lens temperatures (similar to vehicle windows fogging up in rainy conditions). These conditions are natural processes, not structural design problems in the exterior lights.

Lens design characteristics may result in moisture developing on the light lens frame surfaces. This also is not a malfunction.

However, if you see large amounts of water accumulation, or large water drops building up inside the lenses, have your vehicle inspected by a dealer.

Accessories

When installing accessories, check the following:

- Do not install accessories on the windshield. They can obstruct your view and delay your reaction to driving conditions.
- Do not install any accessories over areas marked SRS Airbag, on the sides or backs of the front seats, on front or side pillars, or near the side windows. Accessories installed in these areas may interfere with proper operation of the vehicle's airbags or may be propelled into you or another occupant if the airbags deploy.
- Be sure electronic accessories do not overload electrical circuits or interfere with proper operation of your vehicle.
 - **Fuses** P. 658
- Before installing any electronic accessory, have the installer contact a dealer for assistance. If possible, have a dealer inspect the final installation.

Accessories and Modifications

WARNING

Improper accessories or modifications can affect your vehicle's handling, stability, and performance, and cause a crash in which you can be seriously hurt or killed.

Follow all instructions in this owner's manual regarding accessories and modifications.

WARNING

Use of improperly designed, engineered or manufactured high-voltage battery assemblies could cause a fire in your vehicle.

A vehicle fire could result in a crash or injury.

Only use a genuine Honda high-voltage battery assembly, or its equivalent, in your vehicle.

Modifications

Do not modify your vehicle in a manner that may affect its handling, stability, or reliability, or install non-genuine Honda parts or accessories that may have a similar effect.

Even minor modifications to vehicle systems can affect overall vehicle performance. Always make sure all equipment is properly installed and maintained, and do not make any modification to your vehicle or its systems that might cause your vehicle to no longer meet your country's and local regulations.

The on-board diagnostic port (OBD-II/SAE J1962 connector) installed on this vehicle is intended to be used with automobile system diagnostic devices or with other devices that Honda has approved. Use of any other type of device may adversely affect the vehicle's electronic systems or allow them to be compromised, possibly resulting in a system malfunction, drained battery, or other unexpected problems.

Do not modify or attempt to repair your vehicle's high-voltage power system or otherwise modify vehicle electrical systems. Disassembling or modifying electrical equipment can result in a crash or a fire.

If you ever need to replace your vehicle's high-voltage battery assembly outside of warranty coverage, we highly recommend that you only use a genuine Honda high-voltage battery assembly. Genuine Honda high-voltage battery assemblies are designed to work with your vehicle's power system and have been designed, engineered and manufactured to avoid overcharging situations. Non-genuine high-voltage battery assemblies may not have been similarly designed, engineered and manufactured, and installation of such assemblies could result in overcharging, fires, loss of power, or other conditions that may increase the likelihood of a crash or injury.

Accessories and Modifications

When properly installed, mobile phones, alarms, two-way radios, radio antennas, and low-powered audio systems should not interfere with your vehicle's computer controlled systems, such as your airbags and anti-lock brakes.

Honda Genuine accessories are recommended to ensure proper operation on your vehicle.

Handling the Unexpected

This chapter explains how to handle unexpected troubles.

If a Tyre Goes Flat

Temporarily Repairing a Flat Tyre..... 630

Handling of the Jack..... 643

Power System Won't Start

Checking the Procedure..... 644

If the Keyless Remote Battery is Weak .. 645

Emergency Power System Off..... 646

If the 12-Volt Battery Is Dead 647

Overheating

How to Handle Overheating..... 650

Indicator, Coming On/Blinking

If the 12-Volt Battery Charging System Indicator Comes On 651

If the Brake System Indicator (Red) Comes On or Blinks 652

If the Electric Power Steering (EPS) System Indicator Comes On 653

If the Brake System Indicator (Red) Comes On or Blinks at the Same Time When the Brake System Indicator (Amber) Comes On .. 654

If the Low Tyre Pressure/Deflation Warning System Indicator Comes On or Blinks ... 655

If the Transmission System Indicator Blinks along with the Warning Message... 656

If the Power System Indicator Comes On... 657

Fuses

Fuse Locations 658

Inspecting and Changing Fuses..... 665

Emergency Towing..... 667

If You Cannot Open the Charge Lid..... 668

If You Cannot Disengage the Charging Connector..... 669

If You Cannot Open the Tailgate 670

Temporarily Repairing a Flat Tyre

If the tyre has a large cut or is otherwise severely damaged, you will need to have the vehicle towed. If the tyre only has a small puncture, from a nail for instance, you can use the temporary tyre repair kit so that you can drive to the nearest service station for a more permanent repair.

If a tyre goes flat while driving, grasp the steering wheel firmly, and brake gradually to reduce speed. Then stop in a safe place.

1. Park the vehicle on firm, level, and non-slippery ground and apply the parking brake.
2. Put the transmission into **P**.
3. Turn on the hazard warning lights and set the power mode to VEHICLE OFF (LOCK).

Temporarily Repairing a Flat Tyre

The kit should not be used in the following situations. Instead, contact a dealer or a roadside assistant to have the vehicle towed.

- The tyre sealant has expired.
- More than one tyre is punctured.
- The puncture or cut is larger than 4 mm (3/16 inch).
- The tyre side wall is damaged or the puncture is outside the contact area.

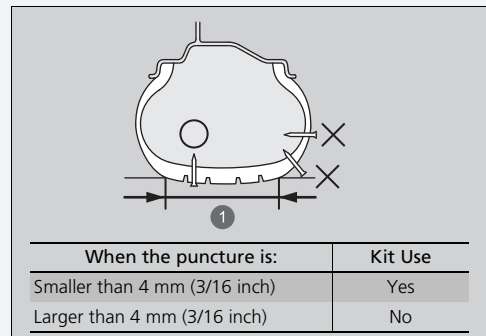

1 Contact Area

- Damage has been caused by driving with the tyres extremely under inflated.
- The tyre bead is no longer seated.
- The rim is damaged.

Do not remove a nail or screw that punctured the tyre. If you remove it from the tyre, you may not be able to repair the puncture using the kit.

■ Getting Ready to Temporarily Repair the Flat Tyre

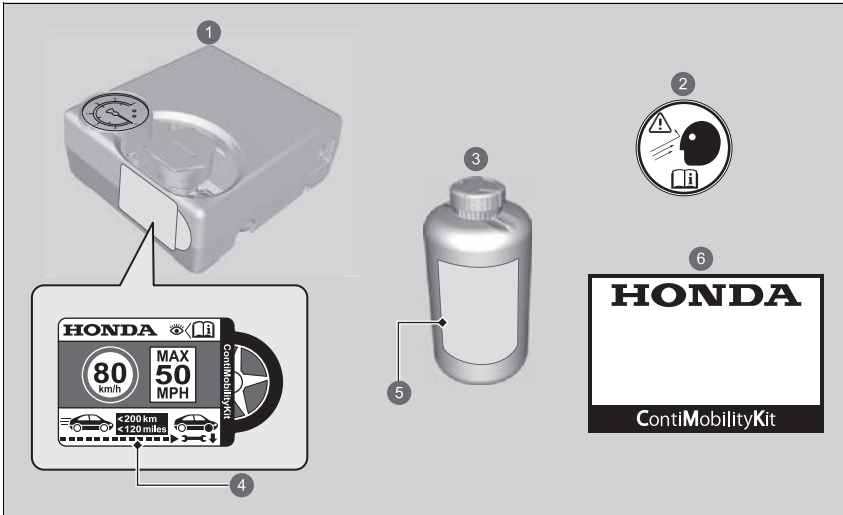

- ① Air Compressor
- ② Wheel Label
- ③ Sealant Bottle
- ④ Speed Restriction Label
- ⑤ Expiration Date
- ⑥ Handling Manual

▣ Getting Ready to Temporarily Repair the Flat Tyre

Speed restriction labels are applied to the side of the temporary tyre repair kit.

When making a temporary repair, carefully read the instruction manual provided with the kit.

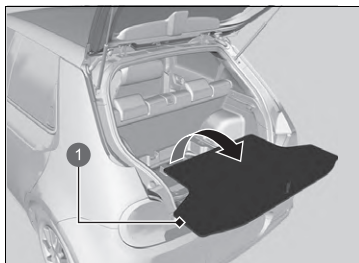

1. Remove the floor lid from the luggage area, then take the kit out of the tool box.
2. Place the kit, face up, on flat ground near the flat tyre, away from traffic. Do not place the kit on its side.

1 Floor Lid

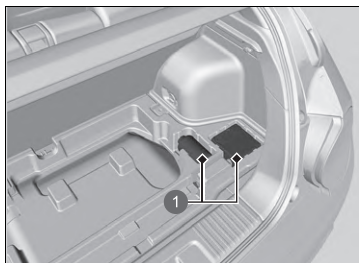

1 Tyre Repair Kit

■ Injecting Sealant and Air

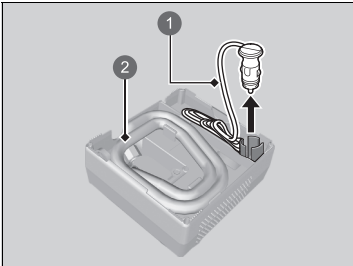

- ① Plug Cord
- ② Air Compressor Hose

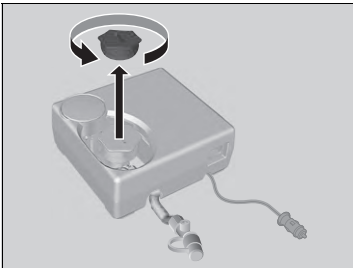

1. Take the air compressor hose and plug cord out of the back of the air compressor.

2. Remove the cap from the air compressor.

▣ Injecting Sealant and Air

⚠ WARNING

Tyre sealant contains substances that are harmful and can be fatal if swallowed.

If accidentally swallowed, do not induce vomiting. Drink plenty of water and get medical attention immediately.

For skin or eye contact, flush with cool water and get medical attention if necessary.

Keep the sealant bottle out of the reach of children.

In cold temperatures, the sealant may not flow easily. In this situation, warm it by keeping the bottle in the passenger compartment before using.

The sealant can permanently stain clothing and other materials. Be careful during handling and wipe away any spills immediately.

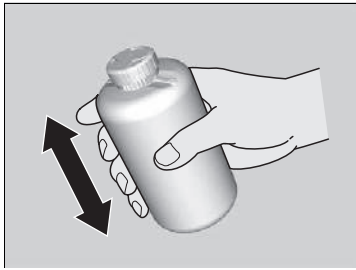

3. Shake the bottle well.

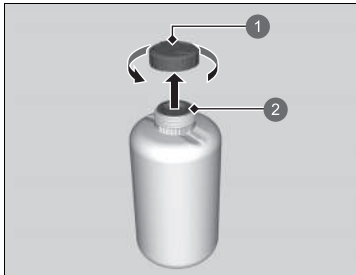

4. Remove the bottle cap.

▶ Do not remove the sealed cover.

- 1 Bottle Cap
- 2 Not Removed

▶▶ Injecting Sealant and Air

Do not remove the empty bottle after injecting the sealant.

See a Honda dealer for a replacement of sealant bottle and proper disposal of the empty bottle.

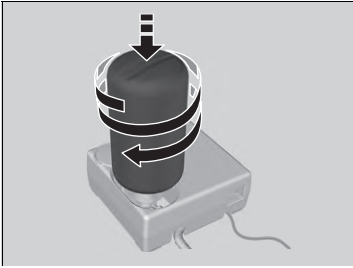

5. Screw the sealed bottle onto the air compressor.
 - ▶ Screw the bottle tightly so that it does not become loose.

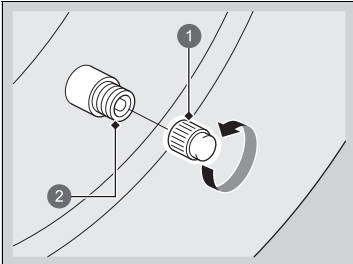

6. Unscrew the valve cap.

- 1 Valve Cap
- 2 Valve

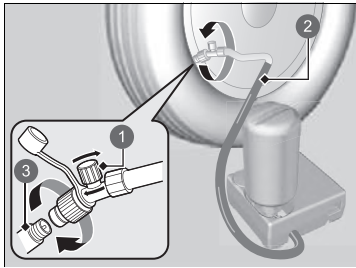

- ① Air Valve
- ② Air Compressor Hose
- ③ Valve

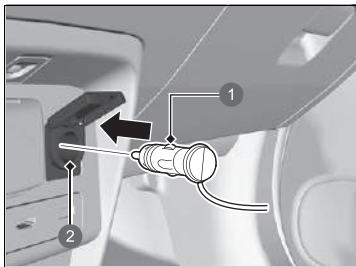

- ① Plug
- ② Accessory Power Socket

7. Screw the air compressor hose onto the tyre valve.
 - Make sure the air valve is closed and the air compressor is turned off.

8. Plug in the compressor to the accessory power socket.
 - ▣ **Accessory Power Socket** P. 242
9. Turn on the vehicle's power system.

▣ Injecting Sealant and Air

Turn the air compressor off when connecting the air compressor hose.

You hear a motor sound coming from the activated air compressor. This is normal.

If the specified air pressure is not reached within 10 minutes, the tyre may be too severely damaged for the kit to provide the necessary seal and your vehicle will need to be towed.

If you want to measure the air pressure using a gauge, turn the air compressor off first.

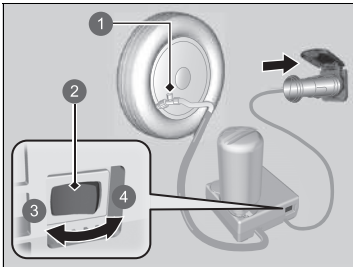

- ① Air Valve
- ② Switch
- ③ OFF
- ④ ON

10. Turn on the air compressor and inflate the tyre to the specified air pressure.
 - ▶ The compressor starts injecting sealant and air into the tyre.
 - ▶ Refer to the driver's doorjamb label for the specified pressure.
11. After the air pressure reaches to specified pressure, turn off the compressor.
 - ▶ Check the air pressure gauge on the air compressor.
 - ▶ If overinflated, release the air by turning the air valve. Be careful not to spill any sealant.
12. Unplug the plug from the accessory power socket.
13. Unscrew the air compressor hose from the tyre valve. Install the hose cap.
 - ▶ Be careful not to spill any sealant when the hose is disconnected. Wipe away any spills.

▶▶ Injecting Sealant and Air

Inform the use of tyre sealant when you ask a Honda dealer or the road assistant service for replacing or repairing the flat tyre.

This air compressor is designed for the automotive tyre. Check the following:

- The power supply of the air compressor is limited to your vehicle's 12-volt DC accessory power socket.
- Do not operate the temporary tyre repair kit compressor for more than 15 minutes. The compressor can overheat and become permanently damaged.
Make it cool down when using the compressor continuously.

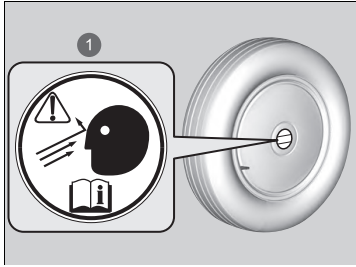

1 Wheel Label

- 14.** Apply the wheel label to the flat surface of the wheel.
 - The wheel surface must be clean to ensure the label adheres properly.
- 15.** Store the tyre repair kit in the luggage area.
 - Do not remove the sealant bottle from the air compressor.

■ Distributing the Sealant in the Tyre

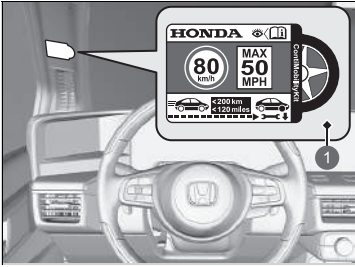

① Speed Restriction Label

1. Apply the speed restriction label to the location as shown.
2. Drive the vehicle for about 10 minutes or three to ten kilometres (two to six miles).
 - ▶ Do not exceed 80 km/h (50 mph).
3. Stop the vehicle in a safe place.

▣ Distributing the Sealant in the Tyre

Refer to the driver's doorjamb label for the specified pressure.

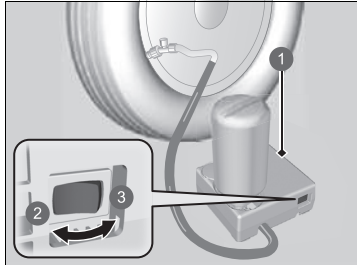

- ① Air Compressor
- ② OFF
- ③ ON

4. Recheck the air pressure using the gauge on the air compressor.
 - ▶ Do not turn the air compressor on to check the pressure.
5. If the air pressure is
 - Less than 130 kPa (1.3 bar, 19 psi): Do not add air and continue driving. The leak is too severe. Call for help and have your vehicle towed.
 - **Emergency Towing** P. 667
 - Specified air pressure (See the label on driver's doorjamb.) or more: Continue driving until you reach the nearest service station. Do not exceed 80 km/h (50 mph).
 - Greater than 130 kPa (1.3 bar, 19 psi);, but less than specified air pressure (See the label on driver's doorjamb.): Inflate the tyre to the specified air pressure.
 - **Inflating an Under-inflated Tyre**
P. 641

And repeat steps 2 to 4 until you reach the nearest service station. Do not exceed 80 km/h (50 mph).

- ▶ The distance to the nearest service station has to be within about 200 kilometres (120 miles).

6. Repackage and properly stow the kit.

■ Inflating an Under-inflated Tyre

You can use the kit to inflate a non-punctured under-inflated tyre.

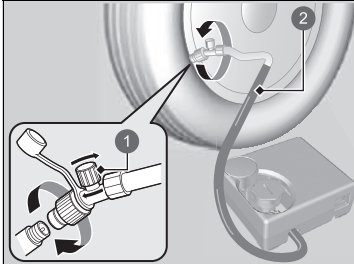

- ① Air Valve
- ② Hose

1. Take the air compressor out of the luggage area.
2. Place the kit, face up, on flat ground near the flat tyre, away from traffic. Do not place the kit on its side.
3. Remove the valve cap.
4. Attach the hose onto the tyre valve. Screw it until it is tight.
 - Make sure the air valve is closed.

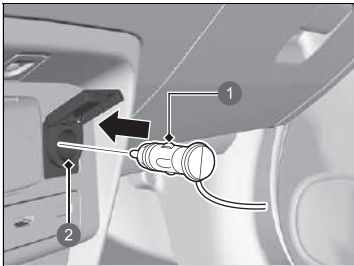

- ① Plug
- ② Accessory Power Socket

5. Plug in the compressor to the accessory power socket.
 - Be careful not to pinch the cord in a door or window.
 - **Accessory Power Socket** P. 242
6. Turn on the vehicle's power system.

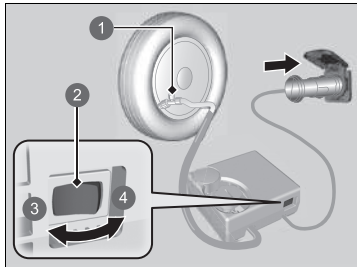

- ① Air Valve
- ② Switch
- ③ OFF
- ④ ON

7. Turn the air compressor switch on to inflate the tyre.
 - ▶ The compressor starts to inject air into the tyre.
 - ▶ If you have started the power system, leave it running while injecting air.
8. Inflate the tyre to the specified air pressure.
9. Turn off the kit.
 - ▶ Check the pressure gauge on the air compressor.
 - ▶ If overinflated, turn the air valve to deflate.
10. Turn on the vehicle's power system off, then unplug the air compressor from the accessory power socket.
11. Unscrew the air compressor hose from the tyre valve. Reinstall the valve cap.
12. Store the air compressor in the luggage area.

▶▶ Inflating an Under-inflated Tyre

NOTICE

Do not operate the temporary tyre repair kit compressor for more than 15 minutes. The compressor can overheat and become permanently damaged.

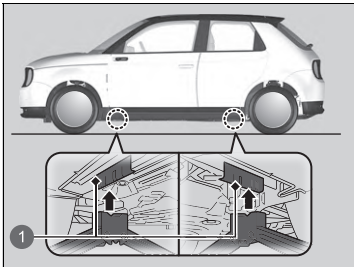

Handling of the Jack

Your vehicle has jacking points as shown.
When replacing your tyres, consult a dealer.



1 Jacking Points

Checking the Procedure







When the  (Ready) indicator does not come on and  does not appear on the driver information interface, check the following items and take appropriate action.

Checking the Procedure



If you must start the vehicle immediately, use an assisting vehicle or booster battery to jump start it.

➤ **If the 12-Volt Battery Is Dead** P. 647

Do not hold the **POWER** button for more than 15 seconds.

Checklist	Condition	What to Do
Check if the related indicator or driver information interface messages come on.	 appears	Removing a charge connector. Set the power mode to ACCESSORY, then to ON.
	 appears	Charge the High Voltage battery. ➤ Charging P. 556
	 appears.	➤ Driver Information Interface Warning and Information Messages P. 130
	 appears. ▶ Make sure the keyless remote is in its operating range.	➤ If the Keyless Remote Battery is Weak P. 645
	The  (Power System) indicator comes on.	Have your vehicle checked by a dealer.
	The transmission system indicator blinks and  appears.	The power system can be activated as a temporary measure. ➤ If the Transmission System Indicator Blinks along with the Warning Message P. 656
Check the brightness of the interior lights.	The interior lights are dim or do not come on at all. The interior lights come on normally.	Have the 12-volt battery checked by a dealer. Check all fuses, or have your vehicle checked by a dealer. ➤ Inspecting and Changing Fuses P. 665
Check the Security System Alarm indicator.	When the Security System Alarm indicator is blinking, the power system cannot be turned on.	➤ Security System Alarm P. 189

If the Keyless Remote Battery is Weak

If the beeper sounds,  appears on the driver information interface, and the **POWER** button flashes, the  (Ready) indicator does not come on.

Turn on the power system as follows:

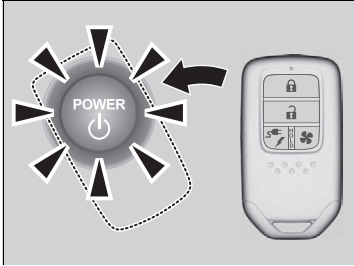

1. Touch the centre of the **POWER** button with the **H** logo on the keyless remote while the **POWER** button is flashing. The buttons on the keyless remote should be facing you.
 - ▶ The **POWER** button flashes for about 30 seconds.

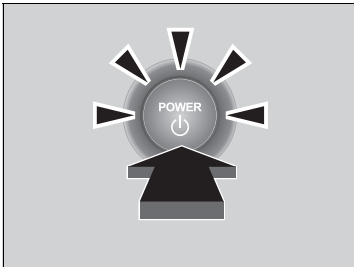

2. Depress the brake pedal and press the **POWER** button within 10 seconds after the beeper sounds and the **POWER** button changes from flashing to on.
 - ▶ The  (Ready) indicator comes on.
 - ▶ If you do not depress the pedal, the mode will change to ACCESSORY.

Emergency Power System Off

The **POWER** button may be used to turn the power system off due to an emergency situation even while driving. If you must turn the power system off, do either of the following operations:

- Press and hold the **POWER** button for about two seconds.
- Firmly press the **POWER** button three times.

The gear position automatically changes to **P** after the vehicle comes to a complete stop. Then, the power mode changes to VEHICLE OFF.

ⓘ Emergency Power System Off

Do not press the **POWER** button while driving unless it is absolutely necessary for the power system to be turned off.
If you press the **POWER** button while driving, the beeper sounds.

If the 12-Volt Battery Is Dead

Jump Starting Procedure

Turn off the power to electric devices, such as audio and lights. Turn off the power system, then open the bonnet.

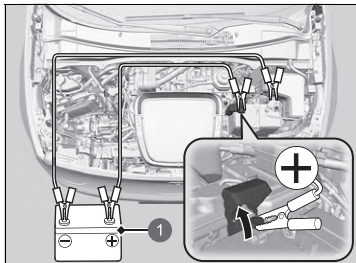

1 Booster Battery

1. Open the terminal cover on your vehicle's 12-volt battery positive \oplus terminal.
2. Connect the first jumper cable to your vehicle's 12-volt battery \oplus terminal.
3. Connect the other end of the first jumper cable to the booster battery \oplus terminal.
 - ▶ Use a 12-volt booster battery only.
 - ▶ When using an automotive battery charger to boost your 12-volt battery, select a lower charging voltage than 15-volt. Check the charger manual for the proper setting.
4. Connect the second jumper cable to the booster battery \ominus terminal.

ⓘ If the 12-Volt Battery Is Dead

⚠ WARNING

A 12-volt battery can explode if you do not follow the correct procedure, seriously injuring anyone nearby.

Keep all sparks, open flames, and smoking materials away from the 12-volt battery.

NOTICE

If a 12-volt battery sits in extreme cold, the electrolyte inside can freeze. Attempting to jump start with a frozen 12-volt battery can cause it to rupture.

Securely attach the jumper cables clips so that they do not come off when the power system vibrates. Also be careful not to tangle the jumper cables or allow the cable ends to touch each other while attaching or detaching the jumper cables.

Continued

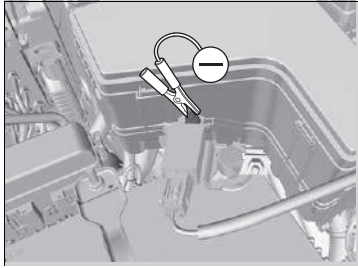

5. Connect the other end of the second jumper cable to the nut of the 12-volt battery sensor \ominus terminal as shown. Do not connect this jumper cable to any other part.
6. If your vehicle is connected to another vehicle, start the assisting vehicle's engine and increase its rpm slightly.
7. Attempt to start your vehicle's power system. If it isn't turn on, check that the jumper cables have good metal-to-metal contact.

⌘ If the 12-Volt Battery Is Dead

12-volt battery performance degrades in cold conditions and may prevent the power system from starting.

Do not force the door to open or close.

There is a mechanism that lowers the window when the door is opened. If the 12-volt battery has died and the window cannot be lowered, it may scrape against the vehicle body when the door is opened or closed. If this happens, slowly open or close the door while pressing down on the upper part of the window.

■ What to Do After the Power System Starts

Once your vehicle's power system has started, remove the jumper cables in the following order.



1. Disconnect the jumper cable from your vehicle's nut of the 12-volt battery sensor \ominus terminal.
2. Disconnect the other end of the jumper cable from the booster battery \ominus terminal.
3. Disconnect the jumper cable from your vehicle's 12-volt battery \oplus terminal.
4. Disconnect the other end of the jumper cable from the booster battery \oplus terminal.

Have your vehicle inspected by a nearby service station or a dealer.

How to Handle Overheating

 appears on the driver information interface when the power system temperature is high.

➤ **Driver Information Interface Warning and Information Messages** P. 130

1. Keep the power mode on, and wait until  goes off.
 - ▶ If  does not go off, have the vehicle inspected at a dealer.

If the 12-Volt Battery Charging System Indicator Comes On



■ Reasons for the indicator to come on

Comes on when the 12-volt battery is not being charged.

■ What to do when the indicator comes on

Stop in a safe place and have your vehicle checked by a dealer immediately.

⚠ If the 12-Volt Battery Charging System Indicator Comes On

If you need to stop temporarily, do not turn off the power system. Restarting the power system may rapidly discharge the battery.

The power system uses the 12-volt battery to activate.

You may not be able to turn the power system on again if you have turned it off with this indicator on.

If the Brake System Indicator (Red) Comes On or Blinks



(Red)

■ Reasons for the indicator to come on

- The brake fluid is low.
- There is a malfunction in the brake system.

■ What to do when the indicator comes on while driving

Depress the brake pedal lightly to check pedal pressure.

- If normal, check the brake fluid level the next time you stop.
- If abnormal, have your vehicle repaired immediately.

■ Reasons for the indicator to blink

- There is a problem with the electric parking brake system.

■ What to do when the indicator lamp blinks

- Avoid using the parking brake and have your vehicle checked by a dealer immediately.

☒ If the Brake System Indicator (Red) Comes On or Blinks

Have your vehicle repaired immediately.

It is dangerous to drive with low brake fluid. If there is no resistance from the brake pedal, stop immediately in a safe place.

If the Brake System Indicator (Red) and **ABS** indicator come on simultaneously, the electronic brake distribution system is not working. This can result in vehicle instability under sudden braking.

Have your vehicle inspected by a dealer immediately.

If the Brake System Indicator (Red) blinks at the same time when the brake system indicator (amber) comes on, the parking brake may not work.

Avoid using the parking brake and have your vehicle checked by a dealer immediately.

☒ If the Brake System Indicator (Red) Comes On or Blinks at the Same Time When the Brake System Indicator (Amber) Comes On

P. 654

If you repeatedly operate the electric parking brake in a short period of time, the brake stops operating to prevent heating of the system and the indicator blinks.

It returns to its original state in approximately 1 minute.

If the Electric Power Steering (EPS) System Indicator Comes On



■ Reasons for the indicator to come on

- Comes on when there is a problem with the EPS system.
- If you depress the accelerator pedal repeatedly to increase the motor speed while the motor is idling, the indicator comes on, and sometimes the steering wheel becomes harder to operate.

■ What to do when the indicator comes on

Stop the vehicle in a safe place, turn off the power system, and turn on the power system again.

If the indicator re-appears and stays on, immediately have your vehicle inspected by a dealer.

If the Brake System Indicator (Red) Comes On or Blinks at the Same Time When the Brake System Indicator (Amber) Comes On



(Red)

■ **If the Brake System Indicator (Red) comes on or blinks at the same time when the Brake System Indicator (Amber) comes on, release the parking brake manually or automatically**

🔧 **Parking Brake** P. 497



(Amber)

- If the Brake System Indicator (Red) continuously comes on or blinks at the same time when the Brake System Indicator (Amber) comes on, stop the vehicle in a safe place and have it inspected by a dealer immediately.
 - ▶ Preventing the vehicle from moving
Put the transmission into **P**.
- If only the Brake System Indicator (Red) is turned off, avoid using the parking brake and have your vehicle checked by a dealer immediately.

🔧 If the Brake System Indicator (Red) Comes On or Blinks at the Same Time When the Brake System Indicator (Amber) Comes On

If you apply the parking brake, you may not be able to release it.

If the brake system indicator (red) and the brake system indicator (amber) come on at the same time, the parking brake is working.

If the brake system indicator (red) blinks at the same time when the brake system indicator (amber) comes on, the parking brake may not work because it is checking the system.

If the Low Tyre Pressure/Deflation Warning System Indicator Comes On or Blinks



■ Reasons for the indicator to come on or blink

A tyre pressure is significantly low, or the deflation warning system has not been calibrated. If there is a problem with the deflation warning system, the indicator blinks for about one minute, and then stays on.

■ What to do when the indicator comes on

Drive carefully and avoid abrupt cornering and hard braking.

Stop your vehicle in a safe place. Check the tyre pressure and adjust the pressure to the specified level. The specified tyre pressure is on a label on the driver side doorjamb.

- ▶ Calibrate the deflation warning system after the tyre pressure is adjusted.

🔧 **Deflation Warning System Calibration** P. 419

■ What to do when the indicator blinks, then remains on

Have the tyre inspected by a dealer as soon as possible.

▶▶ If the Low Tyre Pressure/Deflation Warning System Indicator Comes On or Blinks

NOTICE

Driving on an extremely underinflated tyre can cause it to overheat. An overheated tyre can fail. Always inflate your tyres to the prescribed level.

If the Transmission System Indicator Blinks along with the Warning Message



■ Reasons for the indicator to blink

The transmission is malfunctioning.

■ What to do when the indicator blinks

- Immediately have your vehicle inspected by a dealer.
- Put the transmission into **N** after turning the power system on.
 - ▶ Check if the **N** position in the instrument panel and the indicator on the **N** button light/blink.
 - ▶ The power system cannot be turned on unless the parking brake is set.
 - ▶ **Emergency Towing** P. 379

▶ If the Transmission System Indicator Blinks along with the Warning Message

You may not be able to turn on the power system.

Make sure to set the parking brake when parking your vehicle.

Call a professional towing service if you need to tow your vehicle.

▶ **Emergency Towing** P. 667

If the Power System Indicator Comes On



■ Reasons for the indicator to come on

- Comes on when there is a problem with the electric vehicle system or plug-in charging system.
- Comes on when the High Voltage battery temperature becomes high.

■ What to do when the indicator comes on

Avoid high speeds and immediately get your vehicle inspected by a dealer.

Fuse Locations

If any electrical devices are not working, set the power mode to VEHICLE OFF (LOCK) and check to see if any applicable fuse is blown.

Fuse Box inside the Bonnet

■ Fuse Box A

Located near the 12-volt battery. Push the tabs to open the box.

Locate the fuse in question by the following image and table.

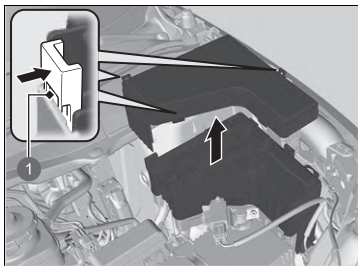

1 Tabs

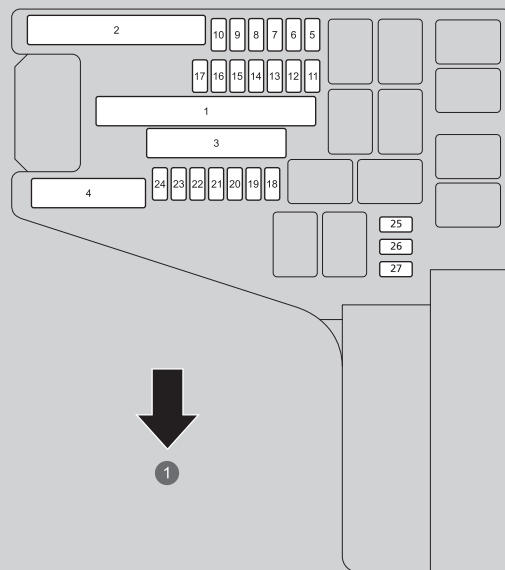

1 Front

■ Circuit protected and fuse rating

	Circuit Protected	Amps
1	FUSE BOX SUB	40 A
	ESB	40 A
	ABS/VSA FSR	40 A
	RELAY MODULE 1	30 A
	IG MAIN 2	30 A
	IG MAIN	30 A
	MAIN FUSE	150 A
2	EPS	70 A
	FUSE BOX MAIN 2	50 A
	ABS/VSA MOTOR	40 A
	COOLING FAN	60 A
	FUSE BOX OPTION 2	50 A
	RELAY MODULE 2	30 A
3	R/BOX MAIN 1	40 A
	FRONT DEICER RIGHT	30 A
	–	–
	FUSE BOX OPTION 1	40 A
	FUSE BOX MAIN 1	40 A
4	BLOWER MOTOR	40 A
	POWER WINDOW MAIN 1	60 A
	POWER WINDOW MAIN 2	60 A
	REAR DEFROSTER	40 A
5	FRONT DEICER LEFT	30 A
	COOLING FAN CONTROL	5 A
6	WIPER	30 A

	Circuit Protected	Amps
7	STOP LIGHTS	10 A
8	IGA	10 A
9	IGB	10 A
10	BACK UP P/P	10 A
11	DT ELECTRIC WATER PUMP 2	10 A
12	–	–
13	HEAD LIGHT CONTROL LEFT	10 A
14	HEAD LIGHT CONTROL RIGHT	10 A
15	DT ELECTRIC WATER PUMP	15 A
16	BATTERY SENSOR	7.5 A
17	IGMG ECU	7.5 A
18	BACK UP	10 A
19	AUDIO	15 A
20	WASHER	15 A
21	ES VLV1	7.5 A
22	ES VLV2	7.5 A
23	HORN	10 A
24	ES ELECTRIC COOLANT HEATER	10 A
25	ES ELECTRIC WATER PUMP	10 A
26	FRONT FOG LIGHT	15 A
27	CHARGE LID ACTUATOR	10 A

■ Fuse Box B

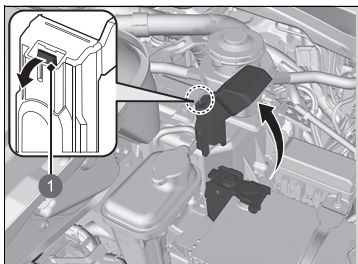

Pull up the cover on the ⊕ terminal, then remove it while pulling out the tab as shown.

■ Circuit protected and fuse rating

	Circuit Protected	Amps
	BATTERY FUSE	175 A

Replacement of fuses inside the bonnet should be done by a dealer.

① Tab

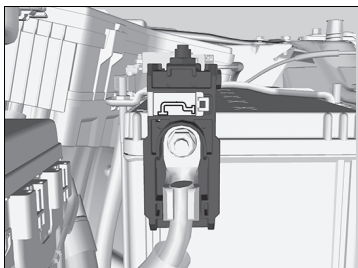

■ Driver Side Interior Fuse Box

■ Fuse Box A

Located behind the instrument panel.

Left-hand drive type

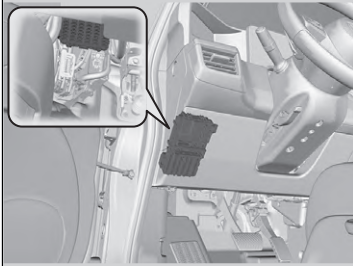

Right-hand drive type

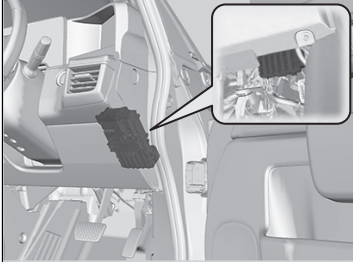

Locate the fuse in question by the following image and table.

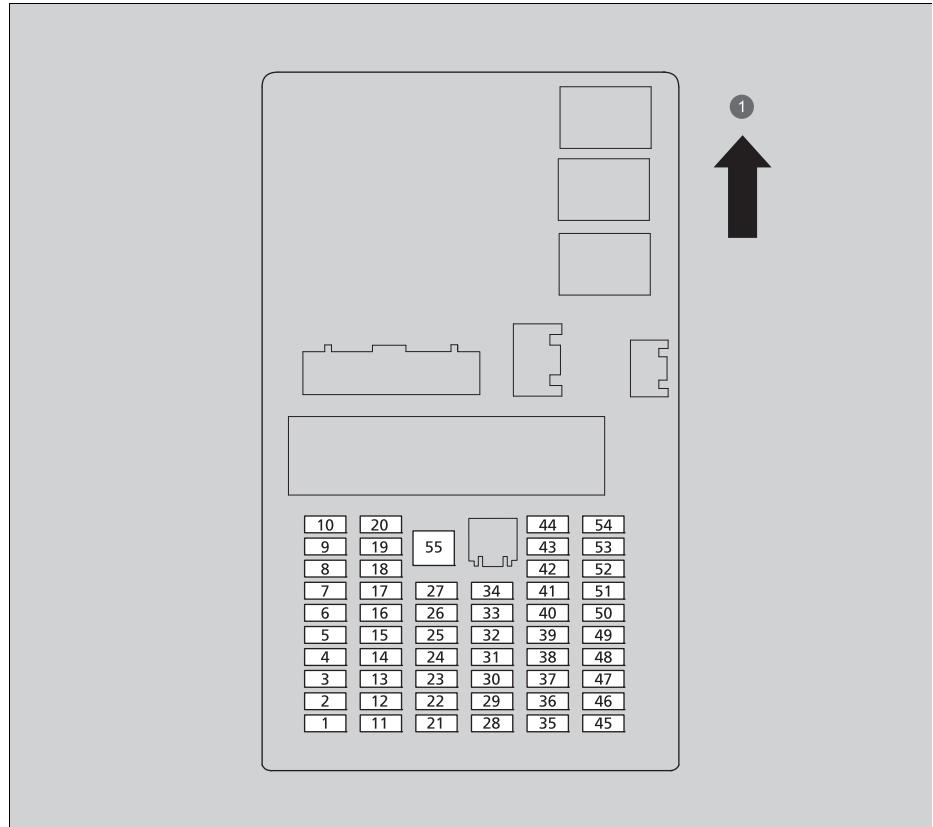

1 UP

■ Circuit protected and fuse rating

	Circuit Protected	Amps
1	–	–
2	LEFT SIDE DOOR UNLOCK	10 A
3	RIGHT SIDE DOOR UNLOCK	10 A
4	ACC	10 A
5	–	–
6	SRS	10 A
7	–	–
8	P-ACT ECU	7.5 A
9	KEYLESS ACCESS	10 A
10	REAR FOG	10 A
11	LEFT SIDE DOOR LOCK	10 A
12	–	–
13	RIGHT SIDE DOOR LOCK	10 A
14	OPTION	10 A
15	DAYTIME RUNNING LIGHT	5 A
16	–	–
17	WIDE MONITOR	10 A
18	HAZARD	10 A
19	CENTRE CAMERA MIRROR SYSTEM	7.5 A
20	QUICK CHARGEING SYSTEM	10 A

	Circuit Protected	Amps
21	–	–
22	–	–
23	COMBO	10 A
24	IMG	10 A
25	SHIFTER	7.5 A
26	LEFT SIDE CAMERA MIRROR SYSTEM	10 A
27	RIGHT SIDE CAMERA MIRROR SYSTEM	10 A
28	ABS/SA	7.5 A
29	ELECTRIC POWER PLANT	7.5 A
30	–	–
31	REAR USB CHARGER	10 A
32	OPTION	10 A
33	–	–
34	FRONT SEAT HEATERS	20 A
35	ACG	10 A
36	METER	10 A
37	OPTION	10 A
38	–	–
39	–	–
40	HEATED STEERING WHEEL	10 A

	Circuit Protected	Amps
41	IGC	10 A
42	–	–
43	AUDIO SUB	7.5 A
44	PREMIUM AMP	20 A
45	REAR WIPER	10 A
46	SRS	10 A
47	–	–
48	A/C MAIN	10 A
49	DOOR LOCK	20 A
50	FRONT ACCESSORY SOCKET	20 A
51	–	–
52	A/C ELECTRIC WATER PUMP	10 A
53	SUPER LOCK*	20 A
54	POPUP DOOR OUTER HANDLE	15 A
55	–	–

Handling the Unexpected

■ Fuse Box B

Located under the fuse box A.

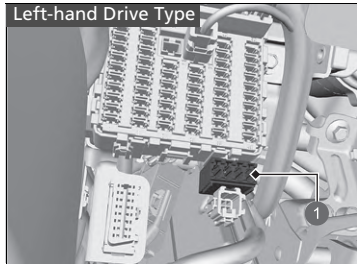

① Fuse Box B

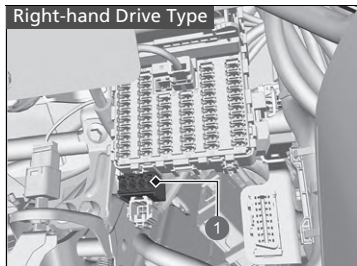

① Fuse Box B

Locate the fuse in question by the following image and table.

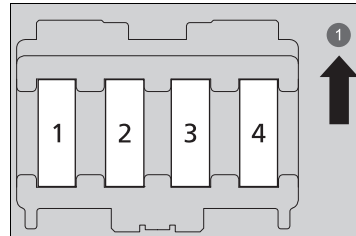

① UP

■ Circuit protected and fuse rating

	Circuit Protected	Amps
1	LEFT REAR POWER WINDOW	30 A
2	PASSENGER'S POWER WINDOW	30 A
3	RIGHT REAR POWER WINDOW	30 A
4	DRIVER'S POWER WINDOW	30 A

■ Rear Fuse Box

Located under the luggage area floor lid.

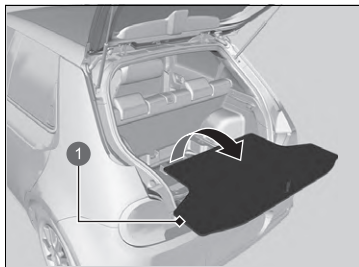

1 Floor Lid

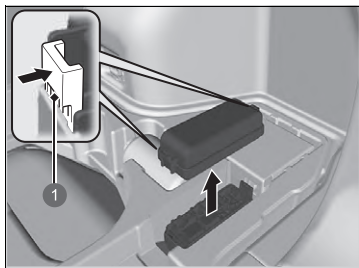

1 Tabs

Locate the fuse in question by the following image and table.

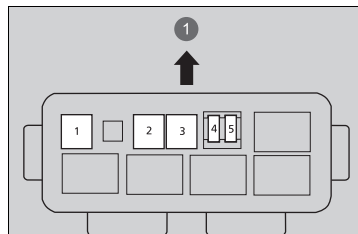

1 Front

■ Circuit protected and fuse rating

	Circuit Protected	Amps
1	EOP	20 A
2	P-ACT	30 A
3	–	–
4	–	–
5	–	–

Inspecting and Changing Fuses

Fuse Box on the Battery

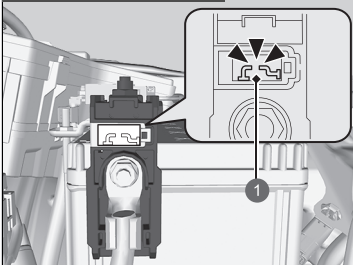

1 Blown

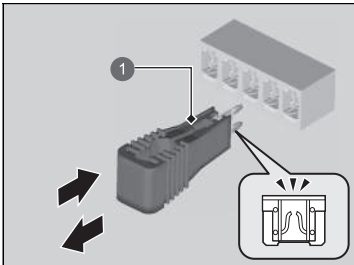

1 Fuse Puller

1. Set the power mode to VEHICLE OFF (LOCK). Turn headlights and all accessories off.
2. Check the fuses on the battery inside the bonnet.
 - ▶ If the fuse is blown, have it replaced by a dealer.
3. Remove the fuse box cover.
4. Inspect the small fuses inside the bonnet and the vehicle interior.
 - ▶ If there is a blown fuse, remove it with the fuse puller and replace it with a new one.

Inspecting and Changing Fuses

NOTICE

Replacing a fuse with one that has a higher rating greatly increases the chances of damaging the electrical system.

Replace a fuse of the same specified amperage. Use the charts to locate the fuse in question and confirm the specified amperage.

➔ **Fuse Locations** P. 658

There is a fuse puller in the fuse box A inside the bonnet.

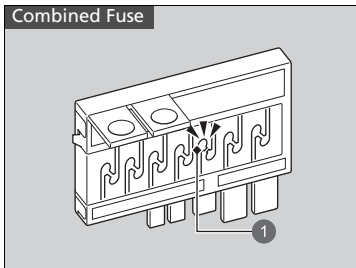

① Blown Fuse

5. Check the large fuse inside the bonnet.
 - If the fuse is blown, use a phillips-head screwdriver to remove the screw and replace it with a new one.

Call a professional towing service if you need to tow your vehicle.

■ Flat bed equipment

The operator loads your vehicle on the back of a truck.

This is the only way you can safely transport your vehicle.

Any other towing method will damage the vehicle's drive system.

» Emergency Towing

NOTICE

Trying to lift or tow your vehicle by the bumpers will cause serious damage. The bumpers are not designed to support the vehicle's weight.

Improper towing such as towing behind a motorhome or other motor vehicle can damage the transmission.

Never tow your vehicle with just a rope or chain. It is very dangerous since ropes or chains may shift from side to side or break.

If You Cannot Open the Charge Lid

■ What to Do If Unable to Open the Charge Lid

If you cannot open the charge lid, use the following procedure.

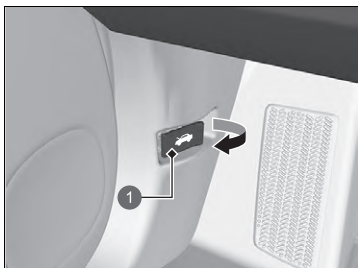

1 Bonnet Release Handle

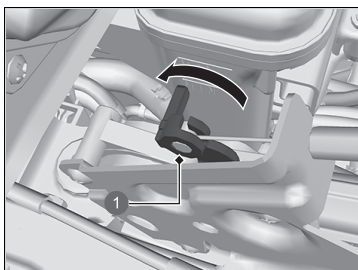

1 Release Lever

1. Open the bonnet.

➤ **Opening the Bonnet** P. 586

2. Pull the release lever near the charge lid.

☞ If You Cannot Open the Charge Lid

After taking this step, contact a dealer to have the vehicle checked.

■ What to Do If Unable to Disengage the Charging Connector

■ When Appears on the Driver Information Interface

 appears on the driver information interface when you cannot disengage the charging connector.

Disengage the charging connector as follows.



① Release Cord

■ If the Remote Battery Is Weak

The charging connector cannot be disengaged if the door is locked while the keyless remote cannot be detected, such as when the battery is weak.

You can disengage the charging connector by pressing the release button in the inlet by unlocking the door with the built-in key.

➤ **Replacing the Button Battery** P. 614

➤ **If the Keyless Remote Battery is Weak** P. 645

⚠ If You Cannot Disengage the Charging Connector

If the problem that you cannot disengage the charging connector occurs repeatedly, contact a dealer to have the vehicle checked.

If You Cannot Open the Tailgate

What to Do If Unable to Open the Tailgate

If you cannot open the tailgate, use the following procedure.

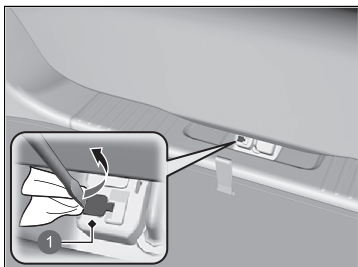

1 Lid

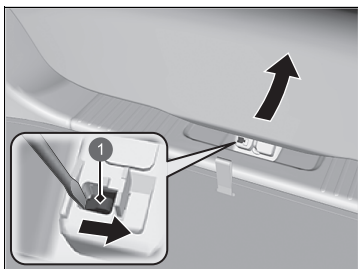

1 Lever

1. Use a flat-tip screwdriver and open the lid on the back of the tailgate.
 - ▶ Wrap the flat-tip screwdriver with a cloth to prevent scratches.

2. To open the tailgate, push the tailgate while sliding the lever to the right with the flat-tip screwdriver.

What to Do If Unable to Open the Tailgate

Following up:

After taking these steps, contact a dealer to have the vehicle checked.

When you open the tailgate from inside, make sure there is enough space around the tailgate, and it does not hit anyone or any object.

Information

This chapter includes your vehicle's specifications, locations of identification numbers, and other information required by regulation.

Specifications	672
Identification Numbers	
Vehicle Identification Number (VIN), Motor Number, and Transmission Number	674
Devices that Emit Radio Waves	675
Declaration of Conformity Content	
Outline*	685

* Not available on all models

■ Vehicle Specifications

Model	Honda e
Curb Weight	1,513 - 1,543 kg (3,336 - 3,402 lbs)
Maximum Permissible Weight	See the certification label on the driver's doorjamb ^{*1} See the certification label on the passenger's doorjamb ^{*2}
Maximum Permissible Axle Weight	See the certification label on the driver's doorjamb ^{*1} See the certification label on the passenger's doorjamb ^{*2}

*1: Left-hand drive type

*2: Right-hand drive type

■ 12-volt Battery

Capacity	36AH(5)/45AH(20)
----------	------------------

■ Washer Fluid

Tank Capacity	2.5 L (2.2 Imp qt)
---------------	--------------------

■ Light Bulbs

Headlights (High/Low Beam)	LED
Position/Daytime Running Lights	LED
Front Turn Signal Lights	LED
Front Fog Lights	LED
Side Turn Signal Lights (on Side Camera Mirror System)	LED
Brake Lights	LED
Taillights	LED
Rear Turn Signal Lights	LED
Back-Up Lights	LED
Rear Fog Light	LED
Rear Licence Plate Lights	LED
High-Mount Brake Light	LED
Door Outer Handle Ambient Lights	LED
Interior Lights	
Map lights	LED
Ceiling Light	LED
Vanity Mirror Lights	1.8 W
Foot Light	LED
Centre Pocket Light	LED
Luggage Area Lights	LED

■ Brake Fluid

Specified	Brake Fluid with DOT 3 or DOT 4
-----------	---------------------------------

■ Air Conditioning

Refrigerant Type	HFO-1234yf (R-1234yf)
Charge Quantity	395 - 445 g (13.9 - 15.7 oz)

■ Transmission Fluid

Specified	Honda ATF DW-1
Capacity	Change 2.1 L (1.8 Imp qt)

■ Tyre

Regular	Size	Front 185/60R16 86H* ¹ 205/45ZR17 (88Y)* ² Rear 205/55R16 91V* ¹ 225/45ZR17 (94Y)* ²
	Pressure	See the label on driver's doorjamb
Wheel Size	Regular	Front 16X6J* ¹ 17X6 1/2J* ² Rear 16X7J* ¹ 17X7 1/2J* ²

*1: Models with 16 inch wheel

*2: Models with 17 inch wheel

■ Honda TRK Air Compressor

A weighted emission sound pressure level	81 dB (A)
A weighted sound power level	90 dB (A)

■ Brake

Type	Power assisted
Front	Ventilated disc
Rear	Solid disc
Parking	Electric Parking Brake

■ Vehicle Dimensions

Length	3,894 mm (153.3 in)	
Width	1,752 mm (69.0 in)	
Height	1,503 mm (59.2 in)	
Wheelbase	2,538 mm (99.9 in)	
Track	Front	1,513 mm (59.6 in)* ¹
		1,523 mm (60.0 in)* ²
	Rear	1,513 mm (59.6 in)* ¹
		1,523 mm (60.0 in)* ²

*1: Models with 17 inch wheel

*2: Models with 16 inch wheel

Vehicle Identification Number (VIN), Motor Number, and Transmission Number

Your vehicle has a 17-digit vehicle identification number (VIN) used to register your vehicle for warranty purposes, and for licensing and insuring your vehicle. The locations of your vehicle's VIN, motor number and transmission number are shown as follows.

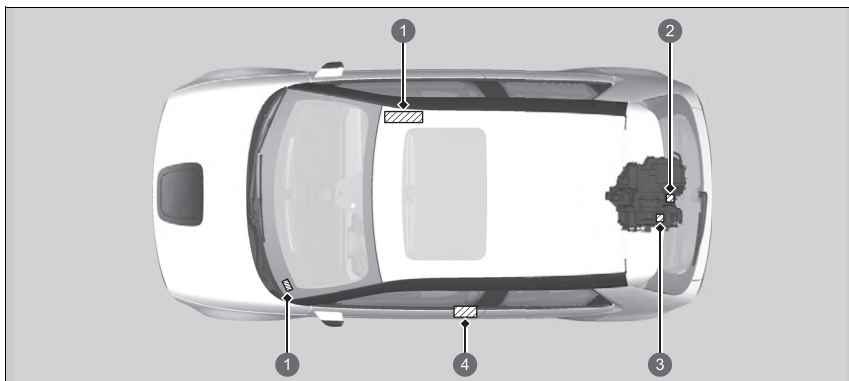

- ① Vehicle Identification Number
- ② Motor Number
- ③ Transmission Number
- ④ Certification Label/Vehicle Identification Number/Motor Number

Vehicle Identification Number (VIN), Motor Number, and Transmission Number

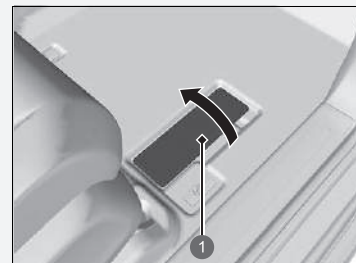

The interior vehicle identification number (VIN) is located under the cover.



- ① Cover

Devices that Emit Radio Waves

The following products and systems on your vehicle emit radio waves when in operation.

	BCM Keyless Access System	FOB Keyless Remote
	<p>http://www.conti-online.com/www/automotive_de_en/contact_en.html</p> <p></p> <p>Hereby, Continental Automotive GmbH declares that this model 40737300 is in compliance with the essential requirements and other relevant provisions of Directive 2014/53/EU.</p> <p>The full text of the EU declaration of conformity is available at the following internet address: http://www.conti-online.com/www/automotive_de_en/contact_en.html</p> <p>Intended use: Short range device for remote control</p> <p>Postal address: Vahrenwalder Str. 9, D-30001 Hannover, Germany Manufacturer name: Continental Aktiengesellschaft Operational frequency band: 125kHz +/- 3kHz Maximum Output Power: 66dBuA/m at 10m Importer Name: Honda Motor Europe Ltd - Aalst Office Postal address: Wijngaardveld 1 (Noord V) 9300 Aalst - Belgium</p>	<p>http://www.conti-online.com/www/automotive_de_en/contact_en.html</p> <p></p> <p>Hereby, Continental Automotive GmbH declares that this model V2x / V4x is in compliance with the essential requirements and other relevant provisions of Directive 2014/53/EU.</p> <p>The full text of the EU declaration of conformity is available at the following internet address: http://www.conti-online.com/www/automotive_de_en/contact_en.html</p> <p>Intended use: Short range device for remote control</p> <p>Postal address: Vahrenwalder Str. 9, D-30001 Hannover, Germany Manufacturer name: Continental Aktiengesellschaft Operational frequency band: 433.66MHz+/-16kHz 434.18MHz+/-16kHz Maximum Output Power: 0dBm Importer Name: Honda Motor Europe Ltd - Aalst Office Postal address: Wijngaardveld 1 (Noord V) 9300 Aalst - Belgium</p>
Except British models		

Hands-Free Telephone System

<http://www.ptc.panasonic.eu/>



Hereby, Panasonic Corporation declares that the radio equipment type Listed above is in compliance with Directive 2014/53/EU. Access to <http://www.ptc.panasonic.eu/>, click "Declaration of Conformity", enter the below Keyword into the keyword search box, you can download the latest "DECLARATION of CONFORMITY" (DoC).

Keyword:: [CL-MH39E2JT, CL-MH39E3JT, CL-MH39E4JT, CL-MH39E5JT]

Intended use:

Car Audio System (Bluetooth and WLAN)

Postal address:

4261 Ikonobe-cho, Tsuzuki-ku, Yokohama-shi, Kanagawa-ken, 224-8520, Japan

Manufacturer name:

Panasonic Corporation

Specifications of Bluetooth

Frequency band: 2402-2480MHz

Specifications of 2.4GHz WLAN

Frequency band: 2412-2472MHz

Specifications of Bluetooth

Maximum output power: 0.1dBm

Specifications of 2.4GHz WLAN

Maximum output power: 11.9dBm

Importer Name:

Honda Motor Europe Ltd - Aalst Office

Postal address:

Wijngaardveld 1 (Noord V) 9300 Aalst - Belgium

Except
British
models

Adaptive Cruise Control (ACC) with Low Speed Follow/Collision Mitigation Braking System (CMBS)	Blind spot information System/Cross Traffic Monitor
<p data-bbox="256 229 528 255">http://ita.bosch.com/radar</p> <div data-bbox="507 274 592 337" style="text-align: center;">  </div> <p data-bbox="256 350 831 490">Hereby, Robert Bosch GmbH declares that the radio equipment type MRRevo14F is in compliance with Directive 2014/53/EU. The full text of the EU declaration of conformity is available at the following internet address: http://ita.bosch.com/radar</p> <p data-bbox="256 497 772 523">Intended use: Motion Detector for TTT application</p> <p data-bbox="256 529 411 555">Postal address:</p> <p data-bbox="256 562 555 610">Daimlerstr. 6 Gebaude 107/1 71229 Leonberg Germany</p> <p data-bbox="256 617 687 642">Manufacturer name: Robert Bosch GmbH</p> <p data-bbox="256 649 687 675">Operational frequency band: 76 - 77 GHz</p> <p data-bbox="256 682 635 707">Maximum Output Power: 29.05dBm</p> <p data-bbox="256 714 826 740">Importer Name: Honda Motor Europe Ltd - Aalst Office</p> <p data-bbox="256 747 411 772">Postal address:</p> <p data-bbox="256 779 754 805">Wijngaardveld 1 (Noord V) 9300 Aalst - Belgium</p>	<p data-bbox="901 229 1316 255">https://www.veoneer.com/en/regulatory</p> <div data-bbox="1152 274 1236 337" style="text-align: center;">  </div> <p data-bbox="901 350 1476 490">Hereby, Veoneer US, Inc. declares that the radio equipment type 6234734 NB24 is in compliance with Directive 2014/53/EU. The full text of the EU declaration of conformity is available at the following internet address: https://www.veoneer.com/en/regulatory</p> <p data-bbox="901 497 1401 523">Intended use: 24 GHz Short Range Radar Sensor</p> <p data-bbox="901 529 1056 555">Postal address:</p> <p data-bbox="901 562 1433 610">26545 American Drive Southfield, Michigan, 48034 United States of America</p> <p data-bbox="901 617 1289 642">Manufacturer name: Veoneer US, Inc.</p> <p data-bbox="901 649 1198 675">Operational frequency band:</p> <p data-bbox="901 682 1102 707">24.05 – 24.25 GHz</p> <p data-bbox="901 714 1166 740">Maximum Output Power:</p> <p data-bbox="901 747 1040 772">10 dBm peak</p> <p data-bbox="901 779 1066 805">Importer Name:</p> <p data-bbox="901 812 1302 837">Honda Motor Europe Ltd - Aalst Office</p> <p data-bbox="901 844 1056 870">Postal address:</p> <p data-bbox="901 876 1398 902">Wijngaardveld 1 (Noord V) 9300 Aalst - Belgium</p>

Except
British
models

Emergency Call (eCall)

<https://www.denso.com/global/en/contact-us/doc/>



Hereby, DENSO CORPORATION declares that the radio equipment type is in compliance with Directive 2014/53/EU. The full text of the EU declaration of conformity is available at the following internet address:

<https://www.denso.com/global/en/contact-us/doc/>

Intended use: Cell phone Receiver for vehicle and Wi-Fi Hotspot device for Vehicle

Postal address:

1-1, Showa-cho, Kariya-shi, Aichi-ken, 448-8661, Japan

Manufacturer name:

DENSO CORPORATION

Operational frequency band:

1) GSM900 (Tx: 880-915 MHz, Rx: 925-960 MHz) 2) GSM1800 (Tx: 1710-1785 MHz, Rx: 1805-1880 MHz) 3) WCDMA Band1 (Tx: 1920-1980MHz, Rx: 2110-2170 MHz) 4) WCDMA Band3 (Tx: 1710-1785 MHz, Rx: 1805-1880 MHz) 5) WCDMA Band8 (Tx: 880-915 MHz, Rx: 925-960 MHz) 6) LTE Band1 (Tx: 1920-1980MHz, Rx: 2110-2170 MHz) 7) LTE Band3 (Tx: 1710-1785 MHz, Rx: 1805-1880 MHz) 8) LTE Band7 (Tx: 2500-2570 MHz, Rx: 2620-2690 MHz) 9) LTE Band8 (Tx: 880-915 MHz, Rx: 925-960 MHz) 10) LTE Band20 (Tx: 832-862 MHz, Rx: 791-821 MHz) 11) WLAN IEEE802.11b (Tx/Rx: 2401-2473 MHz) 12) WLAN IEEE802.11g (Tx/Rx: 2402-2472 MHz) 13) WLAN IEEE802.11n (Tx/Rx: 2402-2472 MHz) 14) GPS (Rx: 1575.42 MHz) 15) GALILEO (Rx: 1575.42 MHz) 16) EGNOS (Rx: 1575.42 MHz)

Maximum Output Power:

1) 2 W 2) 1 W 3-5) 0.25 W 6)-10) 0.20 W 11) 0.032 W 12),13) 0.016 W

Importer Name:

Honda Motor Europe Ltd - Aalst Office

Postal address:

Wijngaardveld 1 (Noord V) 9300 Aalst - Belgium

Except
British
models

Remote Tuner

<http://www.ptc.panasonic.eu/>



RE Directive DoC:

Hereby, Panasonic Corporation declares that the radio equipment type Listed above is in compliance with Directive 2014/53/EU. Access to <http://www.ptc.panasonic.eu/>, click "Declaration of Conformity", enter the below Keyword into the keyword search box, you can download the latest "DECLARATION of CONFORMITY" (DoC). Keyword: Model No.

Except
British
models

Keyword: [CQ-TH39E0AJ]

You can see "Ref No" in unit label.

Intended use:

RADIO UNIT (Car radio tuner)

Postal address:

4261 Ikonobe-cho, Tsuzuki-ku, Yokohama-shi,
Kanagawa-ken, 224-8520, Japan

Manufacturer name:

Panasonic Corporation

Importer Name:

Honda Motor Europe Ltd - Aalst Office

Postal address:

Wijngaardveld 1 (Noord V) 9300 Aalst - Belgium

	BCM Keyless Access System	FOB Keyless Remote
	http://continental-homologation.com/honda	http://continental-homologation.com/honda
	UK CA	UK CA
British models	<p>Hereby, Continental Automotive GmbH declares that this model [40737300] is in compliance with the essential requirements and other relevant provisions of Radio Equipment Regulations 2017.</p> <p>The full text of the UK declaration of conformity is available at the following internet address: http://continental-homologation.com/honda</p> <p>Intended use: Short range device for remote control</p> <p>Postal address: Siemensstrasse 12 D-93055 Regensburg Germany</p> <p>Manufacturer name: Continental Automotive GmbH Operational frequency band: 125kHz +/- 3kHz Maximum Output Power: 66dBuA/m at 10m Importer Name: Honda Motor Europe Ltd. Postal address: Cain Road, Bracknell, Berkshire, RG12 1HL, United Kingdom</p>	<p>Hereby, Continental Automotive GmbH declares that this model [V2x/V4x] is in compliance with the essential requirements and other relevant provisions of Radio Equipment Regulations 2017.</p> <p>The full text of the UK declaration of conformity is available at the following internet address: http://continental-homologation.com/honda</p> <p>Intended use: Short range device for remote control</p> <p>Postal address: Siemensstrasse 12 D-93055 Regensburg Germany</p> <p>Manufacturer name: Continental Automotive GmbH Operational frequency band: 433.66MHz+/-16kHz 434.18MHz+/-16kHz Maximum Output Power: 0dBm Importer Name: Honda Motor Europe Ltd. Postal address: Cain Road, Bracknell, Berkshire, RG12 1HL, United Kingdom</p>

Hands-Free Telephone System

<https://www.ptc.panasonic.eu/>

UK
CA

Hereby, Panasonic Corporation declares that the radio equipment type [*] is in compliance with The Radio Equipment Regulations 2017.

The full text of the UK declaration of conformity is available at the following internet address:

<https://www.ptc.panasonic.eu/>

enter the below Keyword into the keyword search box, you can download the latest "DECLARATION of CONFORMITY" (DoC).

* Keyword: [CL-MH-----, CA-9H-----,

CL-MH39E2JT, CL-MH39E3JT, CA-9H39E0JT, CA-9H39E3JT, CL-MH39E1JT, CL-MH39EJJT, CL-MH39E0JT, CL-MH3AZ1JT, CA-9H39E4JT, CA-9H39E5JT, CA-9H39E6JT, CA-9H39E7JT, CL-MH4BE0JT, CL-MH4BE1JT, CL-MH4BE6JT, CL-MH4BE2JT, CL-MH4AX0JS, CL-MH4BE1JR, CL-MH4BE2JR, CL-MH4BE3JR, CL-MH1BX1JT, CL-MH1AE6JT, CL-MH1AE0JT, CL-MH1AE2JT, CL-MH1BX0JS, CL-MH1BX2JS, CL-MH1BX3JS, CL-MH1BX4JS] You can see "Ref No" in unit label.

Intended use: Car Audio System (Bluetooth and WLAN)

Postal address:

4261 Ikonobe-cho, Tsuzuki-ku, Yokohama-shi, Kanagawa-ken, 224-8520, Japan

Manufacturer name: Panasonic Corporation

Specifications of Bluetooth

Frequency band: 2402-2480MHz

Specifications of 2.4GHz WLAN

Frequency band: 2412-2472MHz

Specifications of Bluetooth

Maximum output power: 0.1dBm

Specifications of 2.4GHz WLAN

Maximum output power: 11.9dBm

Importer Name: Honda Motor Europe Ltd.

Postal address: Cain Road, Bracknell, Berkshire, RG12 1HL, United Kingdom

British
models

Adaptive Cruise Control (ACC) with Low Speed Follow/Collision Mitigation Braking System (CMBS)

<http://ita.bosch.com/radar>



Hereby, Robert Bosch GmbH declares that the radio equipment type MRRevo14F is in compliance with The Radio Equipment Regulations 2017. The full text of the UK declaration of conformity is available at the following internet address: <https://doc-ita.bosch.com>

Intended use: Motion detector for TTT application

Postal address:

Daimlerstr. 6 Gebaude 107/1

71229 Leonberg Germany

Manufacturer name: Robert Bosch GmbH

Operational frequency band: 76 - 77 GHz

Maximum Output Power: 29.05dBm

Importer Name: Honda Motor Europe Ltd.

Postal address:

Cain Road, Bracknell, Berkshire, RG12 1HL, United Kingdom

British models

Blind spot information System/Cross Traffic Monitor

<https://www.veoneer.com/en/regulatory>



Hereby, Veoneer US, Inc. declares that the object of the declaration described above is in conformity with the relevant Union harmonisation legislation.

<https://www.veoneer.com/en/regulatory>

Intended use: 24 GHz Short Range Radar Sensor

Postal address:

26545 American Drive Southfield, Michigan, 48034

United States of America

Manufacturer name: Veoneer US, Inc.

Operational frequency band:

24.05 – 24.25 GHz

Maximum Output Power:

13 dBm peak

Importer Name:

Honda Motor Europe Ltd.

Postal address:

Cain Road, Bracknell, Berkshire, RG12 1HL, United Kingdom

Emergency Call (eCall)

<https://www.denso.com/global/en/contact-us/doc/>

**UK
CA**

Hereby, DENSO CORPORATION declares that the radio equipment type is in compliance with the relevant statutory requirements.

The full text of the UK declaration of conformity is available at the following internet address:

<https://www.denso.com/global/en/contact-us/doc/>

Intended use: Telematics and Wi-Fi Hotspot device for Vehicle

Postal address:

1-1, Showa-cho, Kariya-shi, Aichi-ken, 448-8661, Japan

Manufacturer name:

DENSO CORPORATION

Operational frequency band:

Model OGEY10

1) GSM900 (Tx: 880-915 MHz, Rx: 925-960 MHz) 2) GSM1800 (Tx: 1710-1785 MHz, Rx: 1805-1880 MHz) 3) WCDMA Band1 (Tx: 1920-1980MHz, Rx: 2110-2170 MHz) 4) WCDMA Band3 (Tx: 1710-1785 MHz, Rx: 1805-1880 MHz) 5) WCDMA Band8 (Tx: 880-915 MHz, Rx: 925-960 MHz) 6) LTE Band1 (Tx: 1920-1980MHz, Rx: 2110-2170 MHz) 7) LTE Band3 (Tx: 1710-1785 MHz, Rx: 1805-1880 MHz) 8) LTE Band7 (Tx: 2500-2570 MHz, Rx: 2620-2690 MHz) 9) LTE Band8 (Tx: 880-915 MHz, Rx: 925-960 MHz) 10) LTE Band20 (Tx: 832-862 MHz, Rx: 791-821 MHz) 11) WLAN IEEE802.11b (Tx/Rx: 2401-2473 MHz) 12) WLAN IEEE802.11g (Tx/Rx: 2402-2472 MHz) 13) WLAN IEEE802.11n (Tx/Rx: 2402-2472 MHz) 14) GPS (Rx: 1575.42 MHz) 15) GALILEO (Rx: 1575.42 MHz) 16) EGNOS (Rx: 1575.42 MHz)

Maximum Output Power:

1) 2 W 2) 1 W 3-5) 0.25 W 6)-10) 0.20 W 11) 0.032 W 12),13) 0.016 W

Importer Name:

Honda Motor Europe Ltd.

Postal address:

Cain Road, Bracknell, Berkshire, RG12 1HL, United Kingdom

British
models

Remote Tuner

<https://www.ptc.panasonic.eu/>



Hereby, Panasonic Corporation declares that the radio equipment type [*] is in compliance with The Radio Equipment Regulations 2017.

The full text of the UK declaration of conformity is available at the following internet address:

<https://www.ptc.panasonic.eu/>

enter the below Keyword into the keyword search box, you can download the latest "DECLARATION of CONFORMITY" (DoC).

* Keyword: [CQ-TH-----, CQ-TH28E0AJ, CQ-TH28E0BJ, CQ-TH39E1AJ, CQ-TH39E1BJ, CQ-TH39E0AJ, CQ-TH39E0BJ, CQ-TH1BE0AJ, CQ-TH1BE0BJ, CQ-TH1BE1AJ, CQ-TH1BE1BJ, CQ-TH1AE0TT, CQ-TH1AE0TS, CQ-TH2BE0AD, CQ-TH2BE0BD, CQ-THVCE0AD, CQ-THVCE0BD, CQ-TH4BE0AJ, CQ-TH4BE0BJ, CQ-THVCE1AD, CQ-THVCE1BD] You can see "Ref No" in unit label.

Intended use:

Radio unit (Car radio tuner)

Postal address:

4261 Ikonobe-cho, Tsuzuki-ku, Yokohama-shi, Kanagawa-ken, 224-8520, Japan

Manufacturer name:

Panasonic Corporation

Importer Name:

Honda Motor Europe Ltd.

Postal address:

Cain Road, Bracknell, Berkshire, RG12 1HL, United Kingdom

British
models

Compressor

British
models

Continental ContiMobilityKit
Compressor to pump
sealant into tires

524#####



UK-DECLARATION OF CONFORMITY in accordance with UK Government guidance

Manufacturer / Address: Continental Reifen Deutschland GmbH,
Vahrenwalder Straße 9, 30165 Hannover, GERMANY.

Continental Reifen Deutschland GmbH hereby confirms under its
sole responsibility that the designated product, when used as intended,
is in conformity with the essential requirements and other relevant
requirements of following relevant regulations of the United Kingdom.

- Supply of Machinery (Safety) Regulations 2008
- Electromagnetic Compatibility Regulations 2016
- Noise Emission in the Environment by
Equipment for use Outdoors Regulations 2001

Applied designated standards in particular:

DIN EN ISO 12100:2011 EN 50498:2010 EN ISO 3744:2010

Development, production, quality assurance and marketing are
based on the standard IATF 16949.

Hannover, 13.07.2021
Jürgen Buschmann
Director BF ContiKit and
Accessories

Hannover, 13.07.2021
Adrian Baßmann
Regulatory Compliance
Specialist of Non-Tire Products

Numbers

12-Volt Battery	608
Charging System Indicator	112
Maintenance	
(Checking the 12-Volt Battery)	608
Maintenance (Replacing)	611

A

ABS (Anti-lock Brake System)	504
Indicator	116
AC Power Outlet	243
Accessories and Modifications	626
Accessory Power Sockets	242
Acoustic Vehicle Alerting System	402
Adaptive Cruise Control (ACC) with	
Low Speed Follow	445
Adaptive Cruise Control (ACC) with	
Low Speed Follow Distance Indicator ...	123
Adaptive Cruise Control (ACC) with	
Low Speed Follow Indicator (Amber) ...	122
Adaptive Cruise Control (ACC) with	
Low Speed Follow Indicator	
(White/Green)	123
Adding	
Washer	593
Adjustable Speed Limiter	403
Indicator	122
Adjusting	
Front Seats	227
Head Restraints	231

Steering Wheel	214
Adjusting the Sound	276
Air Conditioning System	
(Climate Control System)	246
Defrosting the Windscreen and	
Windows	248
Dust and Pollen Filter	617
Recirculation/Fresh Air Mode	247
Remote Climate Pre-Conditioning	249
Sensor	251
Using Automatic Climate Control	246
Air Pressure	673
Airbags	57
After a Collision	59
Airbag Care	71
Event Data Recorder	1
Front Airbags (SRS)	59
Indicator	69, 116
Passenger Airbag Off Indicator	116
Sensors	57
Side Airbags	65
Side Curtain Airbags	67
Android Auto	309
Anti-lock Brake System (ABS)	504
Indicator	116
Apple CarPlay	305
Audio Remote Controls	261
Audio System	254
Adjusting the Sound	276
Android Auto	309
Apple CarPlay	305

Audio/Information Screen	267
Basic Operation	257
Bluetooth® Audio	298
Clock Setup	273
DAB	288
Display Setup	277
Error Messages	357
EV Menu	317
FM Radio	283
General Information	358
HDMI™	301
HDMI™ Port	260
How to Update Wirelessly	281
How to Update with a USB Device	282
iPod	291
MP3/WMA/AAC/FLAC, PCM/WAVE	294
MP4/AVI/MKV/ASF/WMV	294
On-Board Owner's Manual	263
Power Flow	313
Reactivating	255
Security Code	255
Start Up	256
Status Area	270
System Updates	278
Theft Protection	255
USB Flash Drives	294, 358
Voice Control Operation	264
Wallpaper Setup	271
Wi-Fi Connection	303
Audio System Theft Protection	255
Reactivating	255

Security Code	255
Audio/Information Screen.....	267
Auto High-Beam	206
Indicator	120
Automatic Brake Hold.....	501
Indicator	109, 501
System Indicator	109
Automatic Intermittent Wipers	211
Average Energy Consumption	159
Average Speed.....	161

B

Battery

12-Volt Battery Charging System	
Indicator	112
Charging	556
Charging System Indicator	651
Energy Economy	570
High Voltage	568
If the 12-Volt Battery is Dead	647
Safety Checklist	556
Belts (Seat)	45
Beverage Holders.....	238
Blind Spot Information System	421
Bluetooth® Audio	298
Booster Seats (For Children).....	101
Brake Assist System.....	505
Brake System.....	497
Anti-lock Brake System (ABS).....	504
Automatic Brake Hold.....	501

Brake Assist System	505
Fluid	591
Foot Brake.....	500
Indicator.....	108, 109, 110, 111, 652, 654
Parking Brake	497
Bulb Replacement	594
Back-Up Lights	595
Brake Lights	594
Charge Lamp	596
Daytime Running Lights.....	594
Door Outer Handle Ambient Lights.....	595
Front Fog Lights	594
Front Turn Signal Lights	594
Headlights.....	594
High-Mount Brake Light	595
Position Lights	594
Rear Fog Light	595
Rear Licence Plate Light.....	595
Rear Turn Signal Lights.....	594
Side Turn Signal/Emergency Indicator	
Lights	594
Taillights.....	594
Vanity Mirror Lights.....	597
Bulb Specifications	672

C

Car Wash Mode	389
Carrying Luggage.....	375, 377
Centre Camera Mirror System	215
Centre Console	237

Certification Label	674
Changing Bulbs	594
Charge Timer Setting	563
Charging	556
AC charger	557
CCS2 DC charger.....	557
Charge Indicator (vehicle side).....	567
DC Charge.....	565
High Voltage Battery	568
Timer	563
Unable to Disengage the Charging	
Connector.....	669
Charging System Indicator	651
Child Restraint System	75
Booster Seats	101
Child Restraint System for Infants.....	78
Child Restraint System for Small	
Children.....	80
Installing a Child Restraint System	
with a Lap/Shoulder Seat Belt.....	96
Larger Children	100
Rearward Facing Child Restraint System ...	78
Selecting a Child Restraint System	81
Using a Tether	98
Child Safety	75
Childproof Door Locks	184
Childproof Door Locks	184
Cleaning the Exterior	623
Cleaning the Interior	620
Climate Control System	246
Changing the Mode.....	246

Front Seat Heaters	245
Front Seats	226
Adjusting	227
Front Sensor Camera	492
Fuses	658
Inspecting and Changing	665
Locations	658, 660, 661, 664

G

Gauges	154
Gear Shift Positions	
Transmission	384
Glass (care)	621, 624
Glove Box	237

H

Hands-Free Telephone System	339
Automatic Import of Mobile Phonebook and Recent calls	349
Automatic Transferring	350
Favourite Contacts	351
HFT Buttons	339
HFT Status Display	341
Limitations for Manual Operation	342
Making a Call	353
Options During a Call	356
Phone Setup	346
Receiving a Call	355
Ringtone	350

Hazard Warning Button	6, 7
HDMI™	301
HDMI™ Port	260
Head Restraints	231
Headlights	201
Aiming	594
Auto High-Beam	206
Dimming	201
Operating	201
Heated Door Mirror Button	213
Heated Steering Wheel	244
Heaters (Front Seat)	245
HFT (Hands-Free Telephone)	339
High Beam Indicator	120
High Beams	202
High Voltage Battery	568
Charging	556
Energy Economy	570
Hill Start Assist System	381
Honda Parking Pilot	531
Honda Sensing	32, 425

I

Identification Numbers	674
Motor and Transmission	674
Vehicle Identification	674
If You Cannot Disengage the Charging Connector	669
If You Cannot Open the Charge Lid	668
If You Cannot Open the Tailgate	670

Immobilizer System	188
Indicator	121
Indicators	106
12-Volt Battery Charging System	112
Adaptive Cruise Control (ACC) with Low Speed Follow	445
Adaptive Cruise Control (ACC) with Low Speed Follow (Amber)	122
Adaptive Cruise Control (ACC) with Low Speed Follow (White/Green)	123
Adaptive Cruise Control (ACC) with Low Speed Follow Distance	123
Adjustable Speed Limiter	122
Anti-lock Brake System (ABS)	116
Auto High-Beam	120
Automatic Brake Hold	109, 501
Automatic Brake Hold System	109
Blind Spot Information	423
Deceleration Paddle Selector	114
Door and Tailgate Open	44
Electric Power Steering (EPS) System	117
Front Fog Light	120
High Beam	120
Immobilizer System	121
Intelligent Speed Limiter	122
Lane Keeping Assist System (LKAS)	469
Lane Keeping Assist System (LKAS) (Amber)	123
Lane Keeping Assist System (LKAS) (Green)	123
Lights On	120

Low Charge	115	Instrument Panel	105	Legal Information on Apple CarPlay/ Android Auto	366
Low Tyre Pressure/Deflation Warning System	118	Intelligent Speed Limiter	408	Lights	201, 594
NORMAL Mode	114	Intelligent Speed Limiter Indicator	122	Bulb Replacement	594
Parking Brake and Brake System (Amber)	110, 111, 654	Interior Lights	234	High Beam Indicator	120
Parking Brake and Brake System (Red)	108, 109, 652, 654	iPhone	358	Interior	234
Parking Sensor (Amber)	124	iPod	291, 358	Light Switches	201
Parking Sensor (Green)	124	J		Lights On Indicator	120
Passenger Front Airbag On/Off	116	Jacking Points	643	Luggage Area Lights	236
Power System	111, 657	Jump Starting	647	Load Limits	377
Ready	112	K		Locking/Unlocking	172
Rear Fog Light	120	Key Number Tag	173	Childproof Door Locks	184
Road Departure Mitigation Ready to Assist	124	Keyless Lockout Prevention	181	From Inside	182
Safety Support (Amber)	125	Keys	172	From Outside	175
Safety Support (Green/Gray)	128	Lockout Prevention	181	Keys	172
Seat Belt Reminder	115	Number Tag	173	Using a Key	180
Security System Alarm	121	Rear Door Won't Open	184	Locking/Unlocking the Doors from the Outside	175
Shift Position	113	Remote Transmitter	178	Lockout Prevention System	181
Side Camera Mirror System	129	Types and Functions	172	Low Battery Charge	651
Single Pedal	124	L		Low Beams	201
SPORT Mode	114	Lane Keeping Assist System (LKAS)	465	Low Charge Indicator	115
Supplemental Restraint System	116	Lane Keeping Assist System (LKAS) Indicator (Amber)	123	Low Keyless Remote Signal Strength	174
System Message	119	Lane Keeping Assist System (LKAS) Indicator (Green)	123	Low Speed Braking Control	439
Transmission System	113	Lead Car Departure Notification System	482	Low Tyre Pressure/Deflation Warning System Indicator	118, 655
Turn Signal and Hazard Warning	119			Lower Anchorages	91
Vehicle Stability Assist (VSA) OFF	117			Luggage (Load Limit)	377
Vehicle Stability Assist (VSA) System	117			Luggage Area Cover	241
VSA OFF	417			Luggage Hook	240

M

Maintenance	571
12-Volt Battery	608
Brake Fluid.....	591
Cleaning.....	620
Climate Control.....	616
Coolant.....	588
Precautions.....	572
Remote Transmitter	614
Replacing Light Bulbs.....	594
Safety.....	573
Service Reminder System	576
Transmission Fluid.....	590
Tyres.....	603
Under the Bonnet.....	585
Making Good Use of Your Honda	
Electric Vehicle.....	14
Map Lights	235
Maximum Charge Setting	569
Maximum Permissible Weight	377
Meters, Gauges	154
Mirrors	215
Modifications (and Accessories)	626
Motor	
Coolant.....	588
Number.....	674
MP3	294
MP3/WMA/AAC/FLAC, PCM/WAVE	294
Multi-View Camera	517

N

Navigation	162
NORMAL Mode Indicator	114
Numbers (Identification)	674

O

Odometer	154
On-Board Owner's Manual	263
Install/Update the Owner's Manual.....	263
Open the Owner's Manual	263
Open Source Licences	361
Opening/Closing	
Bonnet.....	586
Power Windows.....	194
Tailgate.....	186
Other Interior Convenience Items	242
Outside Temperature Display	155
Overheating	650

P

Parking Brake	497
Parking Brake and Brake System	
Indicator (Amber).....	110, 111, 654
Parking Brake and Brake System	
Indicator (Red).....	108, 109, 652, 654
Parking Sensor Indicator (Amber)	124
Parking Sensor Indicator (Green)	124
Parking Sensor System	509
Passenger Front Airbag Off System	62

Passenger Front Airbag On/Off

Indicator	116
Passing Indicators	201
Phone	161
Playing Bluetooth® Audio	298
Pop-up Hood System	72
Pop-up Hood System Care	74
POWER Button	197
Power Flow	313
Power System	
Turning on.....	379
Power System Indicator	111, 657
Power Windows	194
POWER/CHARGE Gauge	154
Precautions While Driving	382
Rain.....	383
Pregnant Women	54
Puncture (Tyre)	630

R

Radar Sensor	494
Radio (FM)	283
Radio Data System (RDS)	286
Range	159
RDS (Radio Data System)	286
Ready Indicator	112
Rear Fog Light Indicator	120
Rear Seat Reminder	229
Rear Seats	229

Regenerative Energy and Regenerative Braking	20
Regulation	675, 685
Remote Climate Pre-Conditioning	249
Remote Transmitter	178
Replacement	
12-Volt Battery	611
Bulbs	594
Fuses	658, 661, 664
Rear Wiper Blade Rubber	601
Wiper Blade Rubber	598
Resetting a Trip Meter	159
Road Departure Mitigation	476
On and Off	479
Ready to Assist Indicator	124

S

Safe Driving	39
Safety Labels	103
Safety Message	0
Safety Support	165
Safety Support Indicator (Amber)	125, 126, 127
Safety Support Indicator (Green/Gray) ...	128
Seat Belts	45
Adjusting the Shoulder Anchor	53
Automatic Seat Belt Tensioners	50
Checking	55
Fastening	51

Installing a Child Restraint System with a Lap/Shoulder Seat Belt	96
Pregnant Women	54
Reminder	48
Warning Indicator	48, 115
Seat Heaters	245
Seats	226
Adjusting	226
Front Seats	226
Rear Seats	229
Seat Heaters	245
Security System	188
Immobilizer System Indicator	121
Security System Alarm Indicator	121
Super Locking	193
Tilt Sensor	192
Ultrasonic Sensors	191
Selecting a Child Restraint System	81
Service Reminder System	576
Shift Button	29
Operation	386
Shift Position Indicator	113
Shifting (Transmission)	29
Shoulder Anchor	53
Side Airbags	65
Side Camera Mirror System	220
Side Camera Mirror System Indicator	129
Side Curtain Airbags	67
Single Pedal Control	396
Single Pedal Indicator	124
Sonar Sensors	494

SOS Button	370
SOS Cancel Button	370
Specifications	672
Speed Limiter, Adjustable	403
Speed Limiter, Intelligent	408
Speedometer	154
SPORT Mode Indicator	114
SRS Airbags (Airbags)	59
Indicator	116
Steering Wheel	214
Adjusting	214
Stopping	507
Super Locking	193
Supplemental Restraint System (SRS)	59
Indicator	116
Switches (Around the Steering Wheel) ...	6, 7, 8, 197
System Message Indicator	119
System Updates	278

T

Tailgate	186
Temperature	
Outside Temperature Display	155
Temperature Sensor	155
Temporarily Repairing a Flat Tyre	630
Temporary Repair Kit (TRK)	630
Theft Protection	255
Tie-down Anchors	240
Tilt Sensor	192

Timer	563
Towing Your Vehicle	
Emergency.....	667
Traffic Sign Recognition System	486
Transmission	29, 383
Creeping	383
Fluid	590
Indicator.....	113
Number.....	674
Operating the Shift Button.....	29, 386
Shift Position Indicator	386
Warning Message.....	656
Trip Meter	159, 161
TRK (Temporary Repair Kit)	630
Troubleshooting	629
Blown Fuse.....	658, 661, 664
Brake Pedal Vibrates	36
Buzzer Sounds When Opening Door.....	37
Charge Lid Won't Open.....	668
Emergency Towing	667
Noise When Braking	38
Overheating.....	650
Power System Won't Start	644
Rear Door Won't Open	36, 184
Tailgate Won't Open	670
Warning Indicators	106
Turn Signals	
Indicators (Instrument Panel).....	119
Turning on the Power	379
Does Not Activate.....	644

Tyres	603
Air Pressure	673
Checking and Maintaining	603
Inspection	603
Rotation	606
Tyre Chains	607
Wear Indicators.....	604
Winter.....	607

U

Ultrasonic Sensors	191
Unlocking the Doors	175
Unlocking the Front Doors from the	
Inside	24
USB Flash Drives	294, 358
USB Ports	259

V

Vanity Mirrors	11
Vehicle Identification Numbers	674
Vehicle Stability Assist (VSA)	416
OFF Indicator.....	117
Off Switch.....	417
System Indicator	117
Voice Control Operation	264
Audio Commands	265
General Commands	265
List Commands	266
Navigation Commands.....	266

Phone Commands	265
Standard Commands	266
Voice Portal Screen	265
Voice Recognition	264
VSA (Vehicle Stability Assist)	416

W

Wallpaper	271, 274
Warning and Information Message	130
Warning Indicator On/Blinking	651
Warning Labels	103
Watts	672
Wear Indicators (Tyre)	604
Wi-Fi Connection	303
Window Washers	210
Adding/Refilling Fluid	593
Switch	210
Windows (Opening and Closing)	194
Windscreen	210
Cleaning.....	621, 624
Defrosting/Defogging	213, 248
Washer Fluid.....	593
Wiper Blades.....	598
Wipers and Washers	210
Winter Tyres	607
Tyre Chains.....	607
Wipers and Washers	210
Automatic Intermittent Wipers.....	211
Checking and Replacing Wiper Blades.....	598
Front.....	210

Rear.....	212
WMA	294
Worn Tyres	603

